



Bridge Plan Directives

Edition 2.0
Effective March 31st, 2017



Justin C. Hernandez, P.E.
Assistant Bridge Division Engineer



FOREWARD

The Oklahoma Department of Transportation (ODOT) Bridge Design Division urges adherence to the Bridge Design Directives (Directives) listed herein to assure uniformity in detailing and drafting convention across the State transportation system. The Directives describe Bridge Division Policy for the production of plans typical to the majority of new bridge construction in the State. This document includes all pertinent information commonly required in the plans as well as procedures for laying out, dimensioning and detailing typical structures and structural components. The Directives should be followed at all times when possible, however, the ultimate design and detailing requirements for any specific set of bridge plans fall upon the judgment of the Engineer of Record for that particular structure or project.

Please forward comments or recommendations on this manual to:

mpearson@odot.org

Copies of this manual may be obtained through The Bridge Division of the Oklahoma Department of Transportation's website:

<http://www.odot.org/>



Steven J. Jacobi, P.E.
Bridge Division Engineer
(405) 521-2606



Bridge Design Plan Directives

Table of Contents

TITLE	5
GENERAL NOTES AND SUMMARY OF PAY QUANTITIES	6
<i>Quantity Box Example</i>	<i>6</i>
ROADWAY PLAN AND PROFILE	7
PLAN VIEW	7
PROFILE VIEW	7
GENERAL PLAN AND ELEVATION.....	8
TITLE BLOCK.....	8
<i>Title Block Example</i>	<i>8</i>
PLAN VIEW	9
ELEVATION VIEW	10
MISCELLANEOUS	11
<i>Index of Sheets Example.....</i>	<i>11</i>
<i>Benchmark Example</i>	<i>11</i>
<i>Engineering Stamp Block Example</i>	<i>12</i>
<i>Bridge Joint Callout Example</i>	<i>12</i>
<i>Design/ Foundation Data Example.....</i>	<i>12</i>
<i>Hydraulic Summary Example</i>	<i>13</i>
<i>Vertical Curve Data Example</i>	<i>13</i>
<i>Figure 1 (Scour)</i>	<i>14</i>
FOUNDATION REPORT	15
SUBSTRUCTURE LAYOUT.....	16
<i>Typical Section Thru Work Road Example</i>	<i>16</i>
<i>Figure 2 (Riprap Section – Conventional)</i>	<i>17</i>
<i>Figure 3 (Riprap Section – Integral)</i>	<i>17</i>
<i>Figure 4 (Detail of Grading).....</i>	<i>17</i>
ABUTMENT	18
<i>Figure 5 (Substructure Layout).....</i>	<i>19</i>
<i>Figure 6 (Pedestal Layout)</i>	<i>20</i>
WINGS.....	21
<i>Figure 7 (Conventional Wing Length Requirements).....</i>	<i>22</i>
BRIDGE EXCAVATION / PIPE UNDERDRAIN.....	23
PIER.....	24

<i>Figure 8 (Pier Detail and Layout Information)</i>	26
SUPERSTRUCTURE	27
<i>Figure 9 (Beveled Anchor Plate)</i>	29
PRESTRESSED CONCRETE BEAM	30
STRUCTURAL STEEL	31
APPROACH SLAB	32
CONVENTIONAL STRUCTURES	32
INTEGRAL BRIDGES.....	32
RIPRAP / SLOPE WALL / GABIONS	34
REINFORCED CONCRETE BOX	35
<i>Figure 10 (Removal of Existing Head Wall)</i>	36
MISCELLANEOUS	37
QUANTITY ROUNDING POLICY	39

TITLE

1. Project Number.
2. State Job Piece Number.
3. Description of Bridge work.
4. Index of Sheets and List of Standards (may move to dedicated second sheet if Title sheet space is limited).
5. Design Data including Traffic Data and Design Speed.
6. Scales, line styles and conventional symbols key.
7. Location of bridge on county location map.
8. Highway type (State Highway, United States Highway, Interstate Highway etc.).
9. Location Number, new and existing NBI Numbers and Control Section Number listed under Bridge Name.
10. Bridge Length shall be rounded to the nearest 1/100 in feet and truncate 1/1000 miles. On repair, maintenance or rehabilitation jobs, Bridge Length may be omitted.
11. Project Engineer and Squad Supervisor names at the outside edge of the left border of the sheet (Consultant and Non-Consultant Plans).
12. Bridge Engineering Manager Stamp if "Bridge Project".
13. Layout Map Information requirements:
 - a. Highway
 - b. Township
 - c. Range
 - d. Sections
 - e. North Arrow
 - f. Bridge name, Bridge Length, Begin and End Stations
 - g. To be scaled (1"=5,280')
14. Note at the bottom left corner stating: 2009 STANDARD SPECIFICATIONS FOR HIGHWAY CONSTRUCTION GOVERN, APPROVED BY THE U.S. DEPARTMENT OF TRANSPORTATION, FEDERAL HIGHWAY ADMINISTRATION, JANUARY 4, 2010.

GENERAL NOTES AND SUMMARY OF PAY QUANTITIES

1. Bridge Notes. When possible, use designated datasets for General Notes.
2. Pay Item Notes.
3. Summary of Pay Items (P.E.S. generated only) including bridge description and NBI Number. Items with (PL) must have related plan note included on the sheet. Items with (SP) must have related special provision in the PS&E package. Pay Item descriptions must match P.E.S. descriptions. Pay Items shall be placed in numeric order according to P.E.S. Item Numbers. See Quantity Box Example below.
4. Structures shall start with 0200. Each structure after 0200 will follow in order. Example: Bridge 'A' is 0200, and Bridge 'B' is 0201. This information will be identical as what is entered into P.E.S.
5. Add BR-1 Note (if applicable) with information on how it applies.

■■■■■(04)		PAY QUANTITIES		
0200		BRIDGE 'A' - NBI ■■■■■ - DESCRIPTION		
ITEM		DESCRIPTION	UNIT	QUANTITY
202(A)	1301	UNCLASSIFIED EXCAVATION	CY	■■■■■
501(A)	1306	STRUCTURAL EXCAVATION UNCLASSIFIED	CY	■■■■■
509(A)	1326	CLASS AA CONCRETE	CY	■■■■■
511(A)	1332	REINFORCING STEEL	LB	■■■■■
619(B)	2500	REMOVAL OF BRIDGE ITEMS	LSUM	■■■■■

Quantity Box Example

ROADWAY PLAN AND PROFILE

PLAN VIEW

1. Proposed bridge, including approach slabs, in solid lines.
2. Existing bridge in dashed lines with abutments and piers.
3. Description of existing bridge.
4. Existing utilities.
5. Riprap, slope wall or any other auxiliary components.
6. Any channel change or modification with typical section through channel change. Include any necessary Right-of-Way.
7. Name of feature intersected, if channel, show direction of flow.
8. Any other structures designed by Bridge Squad/Team. (retaining wall, DEB's, sound wall etc.)

PROFILE VIEW

1. Proposed bridge, including approach slabs and headers, as solid lines. Bridge shown in 10:1 Scale.
2. Begin and End Stations with bridge length.
3. Existing ground line and existing structure along Centerline Survey or Profile Grade Line.
4. Description of proposed bridge including bridge name, centerline station, span arrangement, roadway width, skew, and parapet/railing type. For reinforced concrete box, include the bridge name, centerline station, box spans, roadway width, barrel design, and wing design.
5. Inlet and outlet flowline elevations for reinforced concrete box.
6. Subgrade station and elevation for roadway headers.
7. Hydraulic Data. Give Roadway Division the overtopping elevation and back check Plan and Profile sheet for compliance. Include Hydraulic Data for detours.

GENERAL PLAN AND ELEVATION

Note: General Plan and Elevation sheets are mandatory for all span bridges and reinforced concrete boxes.

TITLE BLOCK

1. Bridge description: Include spans, roadway width, skews, parapet/railing type, and centerline station.
2. Location Information: Include Bridge Name, Intersecting features and county. For instances where there is not enough room, it is permitted to place these items above, or near, the title block.
3. Job Piece Number.
4. Design Squad Information.

BRIDGE "A" LOGAN COUNTY SH-33 OVER COTTONWOOD CREEK <h3 style="text-align: center;">GENERAL PLAN AND ELEVATION</h3> <h4 style="text-align: center;">(SHEET 1 OF 4)</h4> CONSTRUCT (9)x100'-80'-130'-80'-(2)x105' P.C. BEAM TYPE IV AND J P.C. BEAM WITH 7' SIDEWALKS AND HANDRAILS WITH 52' CLEAR RDY AT CENTERLINE STATION 1546+93.28	Design	GT	11/15
	Detail	MAP	11/15
	Check	JCH	11/15
	Squad: PEARSON Engr.: HERNANDEZ		
STATE OF OKLAHOMA	DEPARTMENT OF TRANSPORTATION		
JOB PIECE NO.	21860(04)		SHEET NO. B001

Title Block Example

PLAN VIEW

1. Begin and End Stations for approach slab and bridge. Show alignment stationing for reference. Alignment information (bearing, stationing, station ticks and labels) (Construction Reference Line, Centerline Survey, Profile Grade Line, etc...).
2. For grade separation, indicate point of minimum clearance. Station, elevation and offset should be shown where measured.
3. Cross slope value(s) or superelevation value(s)/data.
4. The existing structure, with piers and abutments, shall be shown in phantom lines.
5. Contours of existing ground at 1' intervals, 2' maximum.
6. Proposed bridge header fill, or excavation, shall be shown with the proper line style.
7. All Bridge Squad/Team designed structures with reference to detail sheet and specific layouts.
8. Name of feature intersected: At a channel, show direction of flow. At a grade crossing, show lane direction arrows. The standard arrows are found in the Bridge Division Standard Cell Library.
9. Any channel change/modification and references to detail sheet with specific layouts.
10. Existing utilities including names of the owners if known.
11. Piling Note.
12. Drains at end of bridge (if applicable).
13. Boring/Sounding locations (use standard Target Cell, with proposed boring number).
14. Standard North Arrow.
15. Location, elevation, station and offset of Survey Benchmarks with at least one for each side of the channel. See [Benchmark Example](#).

ELEVATION VIEW

1. Proposed stations of Begin/ End Bridge, and centerline of piers, shall be shown. Stations shall be shown along PGL/CRL Alignment when Centerline Survey is not on the bridge. Finish Grade information shall be shown in accordance with the example below. Show stations and elevation grid for reference.

← END BRIDGE STATION 1555+34.11
FINISH GRADE ELEVATION 971.02

2. Elevations shall be shown at the top of bridge seat, top of pier cap, and top/bottom of drilled shaft.
3. Fixed, Expansion or Continuous Expansion Joint locations are to be indicated by the use of "FIX.", "EXP." or "CONT. EXP." at the locations determined by the Engineer. Where possible, the callout shall be located within the beam line of the particular location. See [Bridge Joint Callout Example](#).
4. Length, number and size of piling. When length of straight pile exceeds 37'-0", add 1'-0" to the length of the battered pile. No quantity will be added for pile splices. Do not show bottom of pile elevation. For the purpose of calculations, show pile lengths in 6" increments, however, round quantity to the nearest 1'-0". In areas where pilot holes are required for driving piles, a standard note and detail shall be provided by the Design Engineer / Foundation Engineer. The standard note shall be placed into the general notes and details and shall be placed on the Substructure Staking Diagram sheet.
5. Existing ground line along Centerline Survey or Profile Grade Line shall be dashed (style 2). Existing structure, if relevant, shall be shown in phantom lines (style 6). Indicate proposed fill, or excavated slopes including riprap, slope wall or gabions.
6. Foundation information with elevations. Boring location number with tick marks for top, bottom and rock line elevations, do not label rock elevation. "Interpreted Foundation Material" line (style 5) shall be shown connecting rock line elevations at borings. Provide reference to "Foundation Report" sheets for boring data.
7. Pier scour lines, as provided by the Bridge Hydraulics Branch. Show degradation/contraction scour line. (See [Figure 1](#))
8. Indicate true vertical clearance dimension. The dimension shall be calculated and shown in the plans. Lay out the vertical profile of the bridge to meet or exceed the clearances listed below and indicate the location of calculated minimum clearance in plan view.
 - a. Grade Separations: 16'-9" Minimum
 - b. Railroad Under: 23'-10" Minimum

MISCELLANEOUS

1. Design Data, Foundation Data, List of Standards, Utilities, Steel Piling Note and Hydraulic Summary (if applicable) shall conform to the [Design/Foundation Data Example](#).
2. Vertical Profile Data shall conform to the [Vertical Profile Data Example](#).
3. Index of Sheets, see example below.
4. Stations, elevations and dimensions shall be rounded to the nearest hundredth of a foot.
5. When the Project is not a “Bridge Project”, the Bridge Division Project Engineer’s P.E. Stamp Block must be located above the standard title block, on the last General Plan sheet and no larger in width than the title block. See [Engineering Stamp Block Example](#).
6. Show Pier/Contraction Scour in the Elevation View. See [Figure 1 \(Scour\)](#) for more information.
7. General Plan and Elevation sheet(s) for span bridges shall be developed using multiple sheets. Dedicated sheets for the Plan View(s) and Elevation View(s), the last sheet should show Design Data, Index of Sheets etc.. A note shall be placed on the first sheet(s) directing the reader to the appropriate sheet depicting Design Data, Hydraulic Data and Index of Sheets.
8. General Plan and Elevation sheet(s) for RCBs shall be developed using two sheets. One for the Plan View, and the other for the Elevation View, Design Data, Index of Sheets etc.. A note shall be placed on the first sheet directing the reader to the appropriate sheet depicting Design Data, Hydraulic Data and Index of Sheets.
9. Itemized quantities including abutments, piers, superstructure and total. Pay Item Numbers need not be included. Place quantities on Substructure Layout sheet if space is limited on GP&E sheet(s).

INDEX OF SHEETS

NO.	DESCRIPTION
B005-B006	GENERAL NOTES AND SUMMARY OF PAY QUANTITIES
B011-B012	GENERAL PLAN AND ELEVATION (BRIDGE A)

Index of Sheets Example

BENCHMARK NO. 11
 "X" ON NORTHWEST CORNER CONCRETE WALK ON
 NORTHWEST CORNER. OF BRIDGE OVERPASS
 OFFSET: 18' LEFT STATION: 1545+88 ELEVATION: 925.51

Benchmark Example

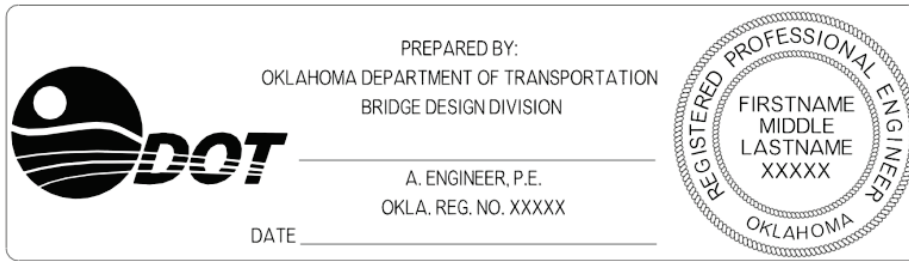

Engineering Stamp Block Example

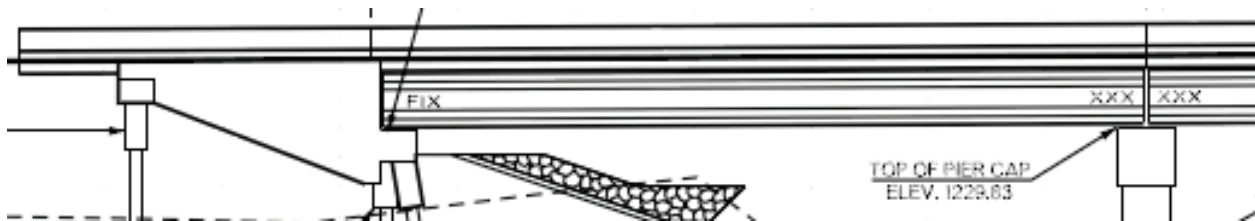

Bridge Joint Callout Example

DESIGN DATA (LOAD RESISTANCE FACTOR DESIGN)

CLASS AA CONCRETE	$f'_c = 4,000$ P.S.I.
CLASS A CONCRETE	$f'_c = 3,000$ P.S.I.
REINFORCING STEEL (GRADE 60)	$f_y = 60,000$ P.S.I.
STRUCTURAL STEEL M270 (GRADE 50W)	$f_y = 50,000$ P.S.I.
STAINLESS STEEL A240 (TYPE 316)	$f_y = 30,000$ P.S.I.

LOADING: HL-93 OR OKLAHOMA OVERLOAD TRUCK AND 20 P.S.F.
FUTURE WEARING SURFACE AND 5 P.S.F. FOR STAY-IN-PLACE FORMS

DESIGN: AASHTO LRFD BRIDGE DESIGN SPECIFICATIONS, 6TH EDITION
ANSI/AASHTO/AWS D 1.5 BRIDGE WELDING CODE
STAINLESS STEEL WELDING CODE
L.F.D OPERATING RATING: HS 49.4

FOUNDATION DATA

ABUTMENTS (HP 12X53 PILING)

ABUTMENT ONE ABUTMENT TWO

FACTORED PILE REACTION	= 56.8 TONS	= 56.8 TONS
PILE LENGTHS	= 33.00 FT	= 33.00 FT

PIERS (XX" DIAMETER DRILLED SHAFTS)

	PIER 1	PIER 2
MINIMUM DEPTH INTO ROCK	= 0.00	= 0.00
DEPTH OF ROCK NEG'D FOR FRICTION	= 0.00	= 0.00
UNIT BEARING RESISTANCE	= 0.00	= 0.00
BEARING RESISTANCE FACTOR	= 0.00	= 0.00
FACTORED BEARING RESISTANCE	= 0.00	= 0.00
UNIT FRICTION RESISTANCE	= 0.00	= 0.00
FRICTION RESISTANCE FACTOR	= 0.00	= 0.00
FACTORED FRICTION RESISTANCE	= 0.00	= 0.00
TOTAL FACTORED RESISTANCE	= 0.00	= 0.00
TOTAL FACOTRED REACTION	= 0.00	= 0.00

Design/Foundation Data Example

HYDRAULIC SUMMARY

TOTAL DRAINAGE AREA = 372.00sq. mi
 CONTROLLED DRAINAGE AREA = 0.00sq. mi
 EFFECTIVE DRAINAGE AREA = 372.00sq. mi

FREQ.	Q (cfs)	CHW (ft)	V (fps)
2	8220	919.86	5.75
5	19800	926.10	836
10	30400	929.13	5.24
25	46800	931.91	5.13
50	61000	933.58	4.88
100	76800	935.32	4.46
500	119000	937.85	5.08
Rdwy OT	37700	930.37	5.21
Detour OT	0	0	0

CONTRACTION SCOUR = 6ft
 PIER SCOUR = 12ft
 TOTAL SCOUR = 18ft

Hydraulic Summary Example

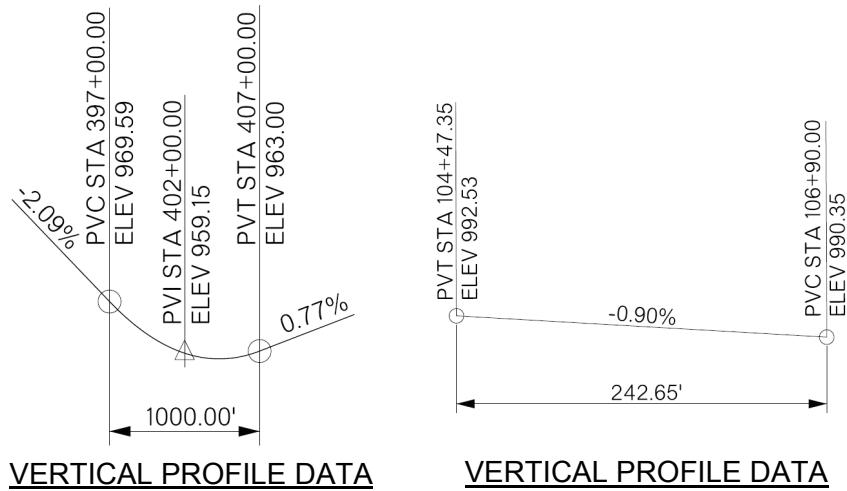

Vertical Profile Data Example for curved and constant profiles

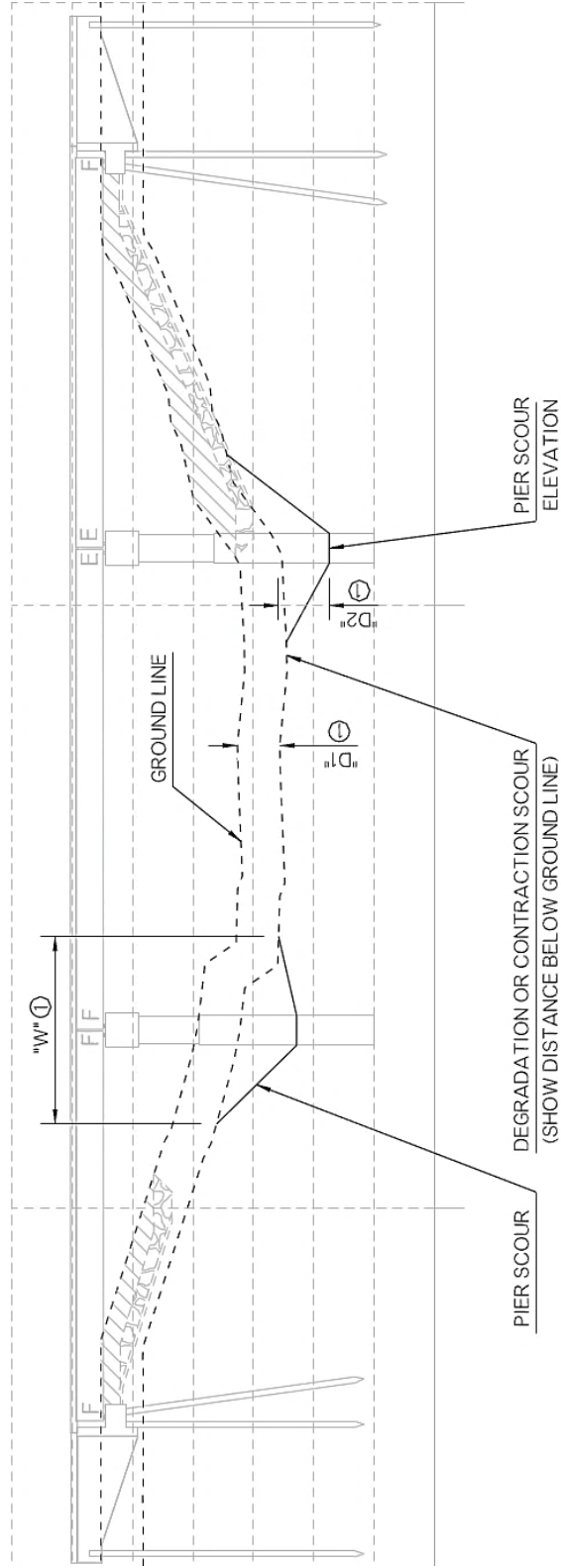

Figure 1 (Scour)

NOTES:

- 1.) PIER SCOUR AND/OR DEGRADATION/CONTRACTION SCOUR SHOWN FOR INFORMATIONAL PURPOSES ONLY AND NOT FOR CONSTRUCTION
- 2.) IF THE CALCULATED PIER SCOUR DEPTH IS BELOW THE TOP OF ROCK, THEN PIER SCOUR DEPTH MAY BE SHOWN AT THE TOP OF ROCK PER THE ENGINEER'S DISCRETION.

① REFERENCE INFORMATION ONLY, NOT TO BE DETAILED ON THE PLANS.

"D1" = DEPTH OF DEGRADATION OR CONTRACTION SCOUR

"D2" = DEPTH OF SCOUR

"W" = "D2" X 25.75

FOUNDATION REPORT

1. All sounding information available (exactly as printed on the boring logs).
2. Include water table symbol and date of water level check. Include note stating water level may fluctuate.
3. Elevations should be shown, rather than depths.
4. Show borings in order of stationing.
5. Any notes located in the soundings.
6. Top of Rock symbol from Design or Foundation Engineer.
7. Note explaining Interpreted Foundation Material Line shown for estimating purposes only.
8. Geological Statement.
9. Scale elevations and stationing of sounding information (when possible).
10. ODOT contact information for complete Geotechnical Report.
11. Use Geotechnical data as provided by Geotechnical Engineer, however, place on the standard drawing sheet.

SUBSTRUCTURE LAYOUT

1. Dimensioning of all piles and drilled shafts from working points. Dimensions shall not start or end at any concrete line, and shall be shown in decimals of feet to two places.
2. Working Points shall be shown along Profile Grade Line when Centerline Survey is not on the bridge, otherwise, use the Centerline Survey for Working Points. Working Points shall be spelled out and shall not be abbreviated.

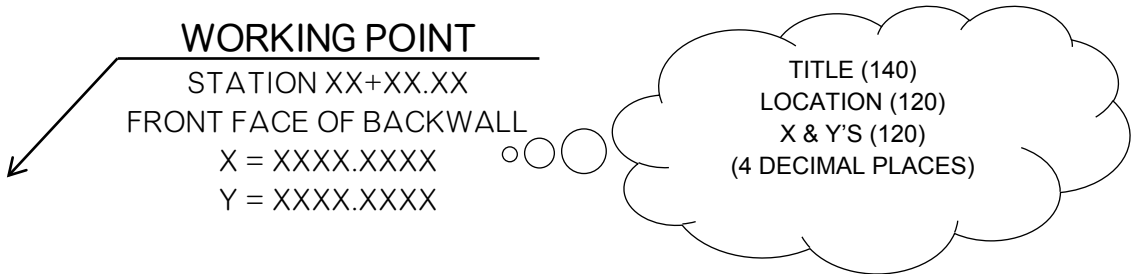

3. Offset dimension of Profile Grade Line to Centerline Survey (if different lines) including survey stationing if necessary.
4. Typical Section Thru Work Road (if applicable). See Typical Section Thru Work Road Example.
5. All bearings, skew angles, working point stations, dimensions, pile, drilled shaft diameters, and North Arrow.
6. Any concrete lines shown shall be in dashed (style 5) lines. (Other than drilled shafts)
7. Bridge header details including subgrade stations and elevations. (see [Figures 2, 3 AND 4](#)). If required by Design or Foundation Engineer, show detail of pilot hole.
8. Place pile note on sheet. "FACE OF PILE WEB SHALL BE PARALLEL TO FACE OF BRIDGE SEAT" for integral abutments. "FACE OF PILE WEB SHALL BE PERPENDICULAR TO FACE OF BRIDGE SEAT" for conventional abutments.
9. Itemized quantity box (if cannot fit on GP&E sheet).
10. Top of pile elevations.

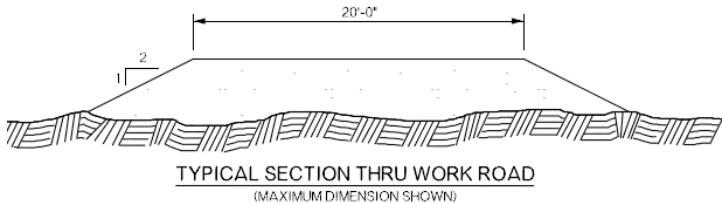

Typical Section Thru Work Road Example

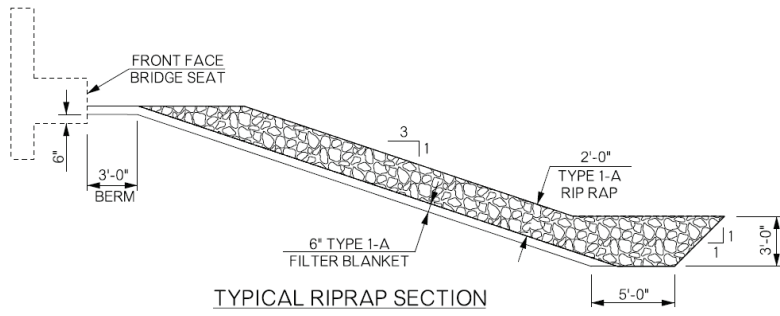

Figure 2 (Riprap Section – Conventional)

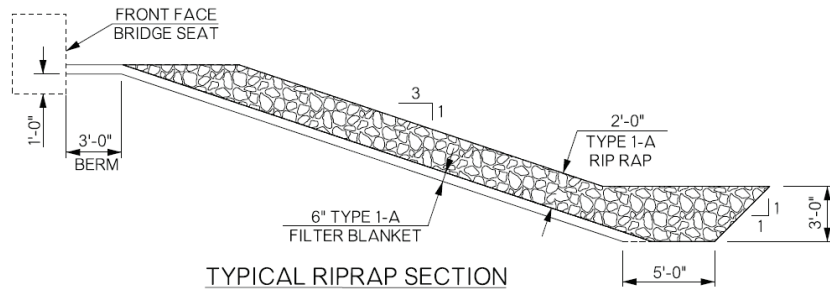

Figure 3 (Riprap Section – Integral)

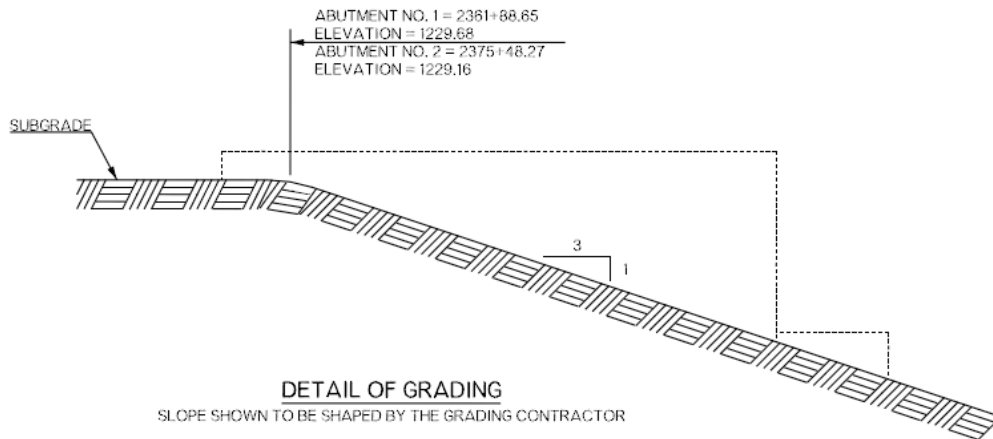
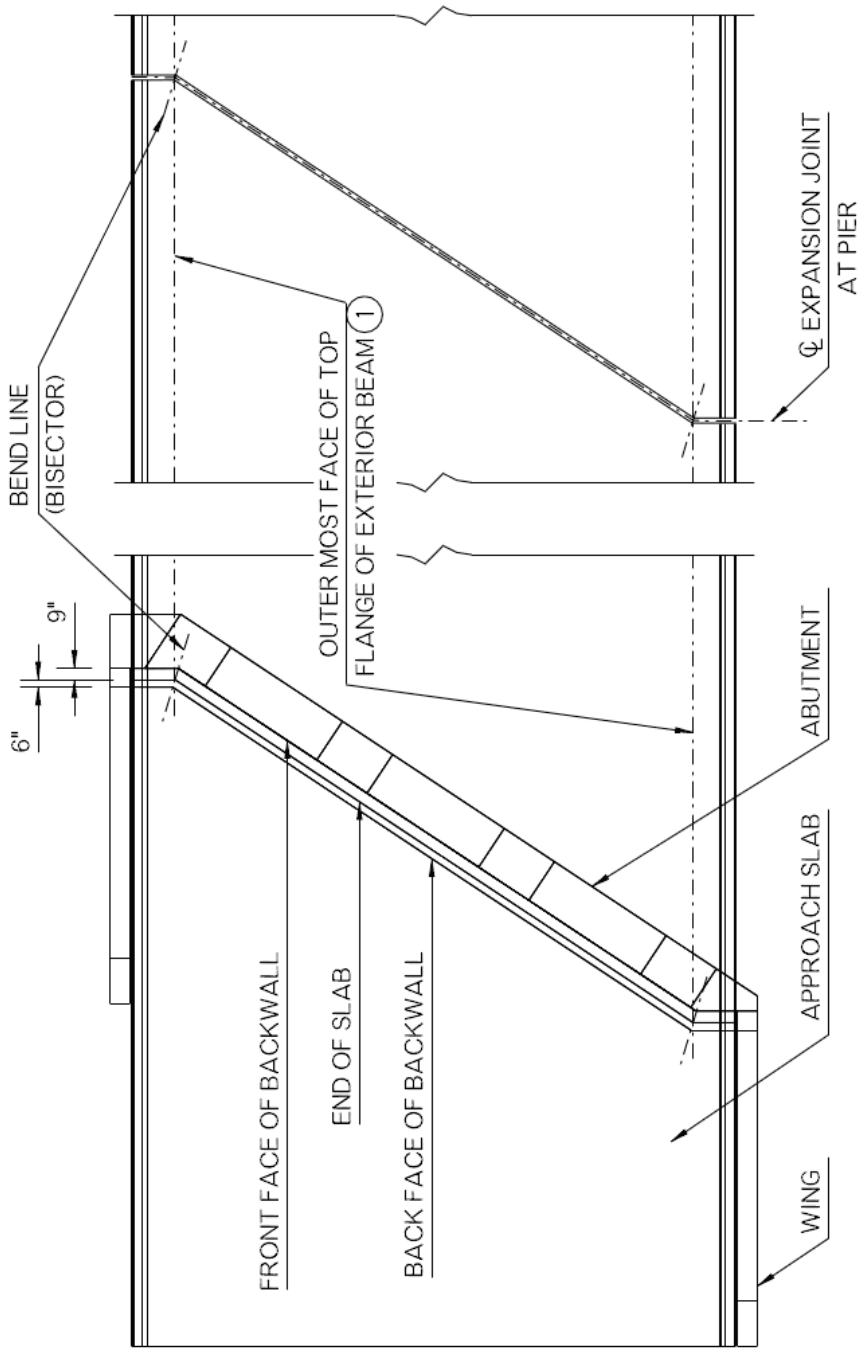

Figure 4 (Detail of Grading)

ABUTMENT

1. Integral abutments should be used for all non-skewed bridges up to 400' long including multiple spans. Bridges that have slight skews, up to 10 degrees, may be considered for integral abutments on a case by case basis, with approval of the Bridge Engineer.
2. Dimensions tied to Profile Grade Line and/or Centerline of Survey and Working Points.
3. Details and dimensions of bridge seat and back wall (including pedestals) and break point of back wall. ([see Figure 5](#))
4. Top edge of bridge seat shall have a 1½" chamfer. All other exposed edges shall have a ¾" chamfer.
5. Bridge seat shall be 3'-0" wide minimum from the front face of back wall to the front face of bridge seat, normal to the back wall. A wider bridge seat may be required to meet the restrictions as shown on [Figure 6](#). Top of bridge seat shall be sloped to drain away from back wall at 5% (perpendicular to back wall). The minimum pedestal height shall be 3", measured at the front face of the back wall. Pedestals shall be reinforced. Pedestals greater than 6" shall have transverse "hoop" bars to be specified by the Design Engineer.
6. Anchor bolt locations and layouts must be shown and detailed, repetitive layouts may be shown once.
7. One pedestal of reinforcing shown is adequate, unless conditions require multiple locations to be shown. Reference pedestals by a letter to the elevation schedule.
8. Wings shall be positioned outside the approach slab width. Indicate pile encasement within the details. See standard [HP1-2](#).
9. All bearings, skew angles, working point stations (location described with no abbreviations), pile size(s) and North Arrow.
10. Top of bridge seat elevation (Conventional - front face of back wall, Integral - back face of bridge seat). Pedestals shall be designated with a letter.
11. Bond breaker shall not be used between the top of back wall and bridge slab/approach slab.
12. Surfaces of the bridge seat and curtain wall to be poured against soil, shall have 3" clearance to reinforcing steel.
13. Water repellent shall be applied on the exposed face of the bridge seat. See Bridge Standard drawings for more details.
14. Reinforcing bar bends, and reinforcing bar List. Round all bar lengths down to the nearest 1".
15. Quantity box containing abutment quantities along with wing quantities.



NOTES:

- ① WHEN USING MIXED BEAM SIZES, USE THE WIDEST BEAM FLANGE TO LOCATE THE BREAK LINE

Figure 5 (Substructure Layout)

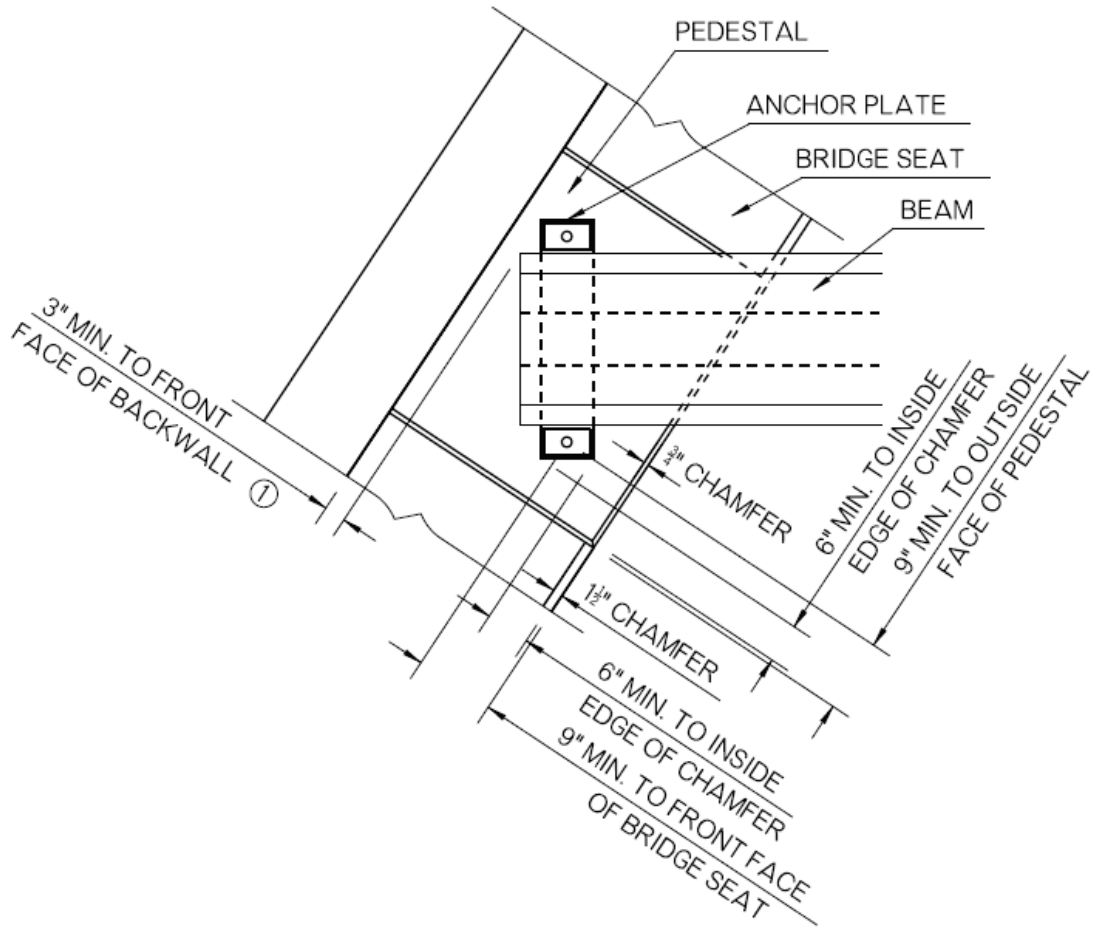

NOTES:

MINIMUM DIMENSION SHOWN MUST BE MAINTAINED.

- ① 3" MIN. FOR FIXED BEARING. AT ABUTMENTS USING AN EXPANSION BEARING; ADD THE AMOUNT OF THE SKEWED EXPANSION REQUIRED. MINIMUM CLEARANCE REQUIRED IS FOR EITHER CORNER OF BEAM OR CORNER OF ANCHOR PLATE, WHICHEVER IS CLOSER.

Figure 6 (Pedestal Layout)

WINGS

1. All wings shall be triangular unless design requirements dictate otherwise. (See [Figure 7](#))
2. Details and dimensions of wings.
3. Roadway face of wing shall not be chamfered.
4. For conventional structures, place pile encasements in accordance with Standard [HP1-2](#). Further, piles shall be embedded vertically in the wing a minimum of 1'-0", have a minimum of 1'-0" vertical cover and shall have a minimum of 6" horizontal clearance. [HP1-2](#) Pile Encasement Standard shall be applied to exposed pile.
5. Piles shall not be used, in wings, on integral bridges.
6. When wing exceeds 20' in length, a second pile may be specified. If wing is structurally adequate, the Design Engineer may determine the second pile may not be required.
7. If the vertical profile grade exceeds 1.5%, the standard wing is not applicable, and a special design is warranted. In this case, elevations should be indicated on both front and rear faces of the wing.
8. Bottom surface of wings that can be poured against soil shall have 3" clearance to reinforcing.
9. Reinforcing bar bends. Show reinforcing bar list. Round all bar lengths down to the nearest 1".
10. Quantity box.

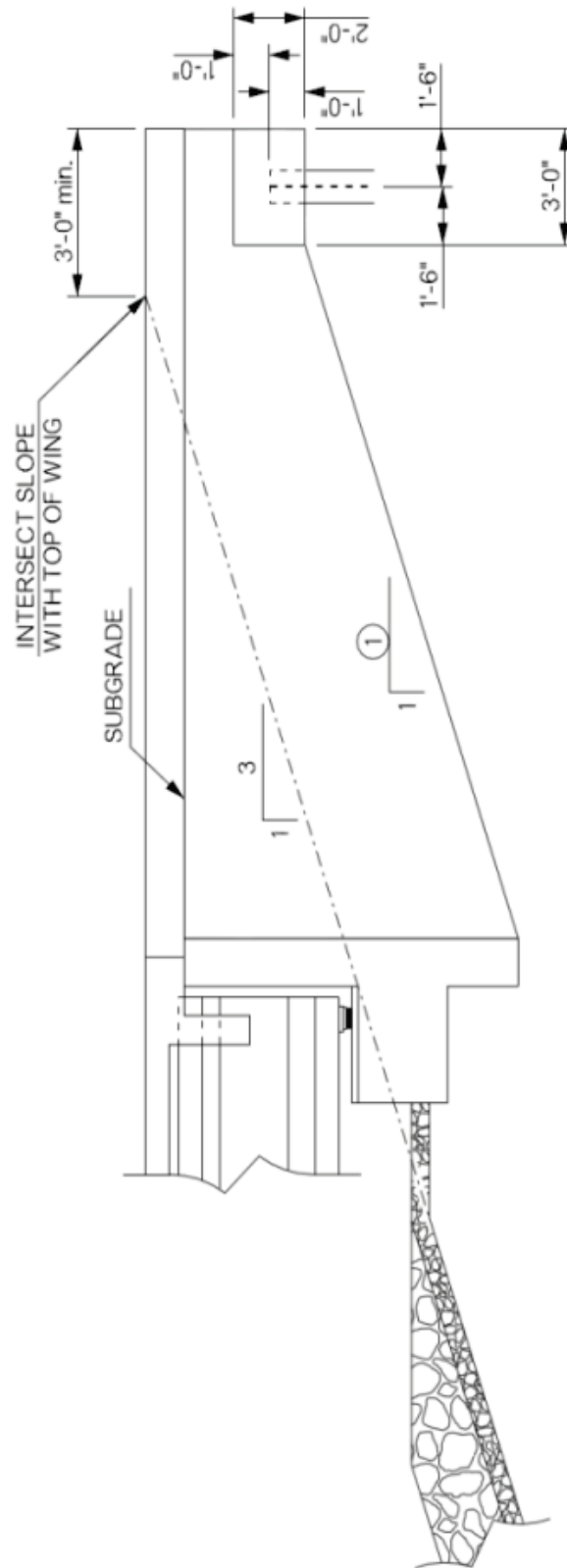

Figure 7 (Conventional Wing Length Requirements)

Note: Conventional Wing shown. Use only for non-standard wings.

BRIDGE EXCAVATION / PIPE UNDERDRAIN

1. Span Bridge
 - a. Details and dimensions of all excavation and fill around abutments and wings.
 - b. Details of pipe underdrain installation.
2. Reinforced Concrete Box (RCB)
 - a. Excavation to be completed in accordance with Roadway Standard [SBI-4](#). For a typical RCB, an Excavation Detail sheet may not be required.

PIER

1. Dimensions tied to Profile Grade Line and/or Centerline of Survey and Working Points.
2. Place note:

ALL EDGES OF PIER CAP SHALL HAVE A 1 ½" CHAMFER EXCEPT FOR PEDESTAL EDGES WHICH SHALL HAVE A ¾" CHAMFER.

3. Details and dimensions of pier including pedestals. Pier cap width shall be determined taking into account restrictions shown [Figure 8](#). Top of pier caps are to be "roof-topped" in shape and shall slope to the edges at a rate of 5% perpendicular to centerline of pier cap. The pier cap vertical dimension and elevation shall be measured from the peak of the slope.
4. Edge of exterior pedestals shall be minimum of 3" from end of pier cap. The minimum pedestal height shall be 3" as measured from the peak of the sloped pier cap. Pedestals shall be reinforced. Pedestals greater than 6" shall have transverse "hoop" bars to be specified by the Design Engineer.
5. When stepped pier cap is required, both levels of pedestals in beam line shall be the same height. Grade adjustment from bearing to bearing shall be accounted for in the step (See [Figure 8](#)). Lower elevation shall be shown on the plans. Each stepped side should slope to drain from the centerline of pier at a rate of 5% perpendicular to pier cap.
6. All bearings, skew angles, working point stations (location described with no abbreviations), pile sizes and North Arrow shall be shown on the sheet.
7. Anchor bolt locations and layouts shown and detailed, repetitive layouts may be shown once. Pedestals shall be indicated by a letter and related to an elevation schedule.
8. All pier cap reinforcing, and any column / drilled shaft reinforcing projecting into pier cap, shall be epoxy coated.
9. Top of pier cap elevation (measured at peak of slope), and top and bottom drilled shaft elevations to be shown. Common dimensional guidelines:
 - a. Column lengths to be figured in 3" increments.
 - b. Drilled shaft lengths to be figured in 12" increments.
 - c. For piers with sloping pier caps, column lengths may be varied.

10. Construction keys between pier cap and column/drilled shaft, shall be formed downward.
11. Drilled shaft size and pay length including minimum drilled shaft into rock. Show top to bottom of drilled shaft as pay length. Reinforcing projecting from the drilled shaft shall be included in the cost of the drilled shaft. A note shall be included to clarify that the projection length shall not be considered additional pay length for drilled shaft.
12. Add Note:

PENETRATING WATER REPELLENT TREATMENT SHALL BE APPLIED TO THE TOP OF THE PIER CAP, INCLUDING ALL SURFACES OF THE PEDESTALS, AND ALL VERTICAL FACES OF THE PIER CAP

13. Specific Details

- a. Spiral Bar Splice
 - i. 2'-0" splice length
 - ii. 10" Hooks
 - b. Concrete Roller Detail (see [Figure 8](#))
 - c. Section Views of Drilled Shaft and/or Column
14. Tie bars in top of drilled shaft shall have 1'-0" lap with 6" hooks.
 15. Column reinforcing shall have 4" clearance on the sides, 3" clearance on the bottom and 2" clearance on the top.
 16. Drilled shaft reinforcing shall have 6" clearance sides and 3" top and bottom.
 17. Reinforcing bar bends.
 18. Reinforcing bar list. Round all bar lengths down to the nearest 1".
 19. Quantity box. A reinforcing splice is required if reinforcing length exceeds 60 ft.
 20. Crosshole Sonic Logging (CSL) Tubes shall be accounted for in clearances. Pay Item, Crosshole Sonic Logging, shall be included in the quantity boxes.
 21. Drilled shaft concrete is specified as Class AA per Subsection 516.02 in the ODOT Standard Specifications. In design calculations, drilled shaft concrete shall be modeled as having a 28 day compressive strength of 3,000 psi. This reduction in concrete design strength will, in effect, provide a factor of safety in drilled shaft material and construction quality mitigating the need for costly repair and/or replacement due to deficiencies in the as-built drilled shaft. Concrete compressive strength of 3,000 psi is for calculation purposes only and shall not be reported in the plans.

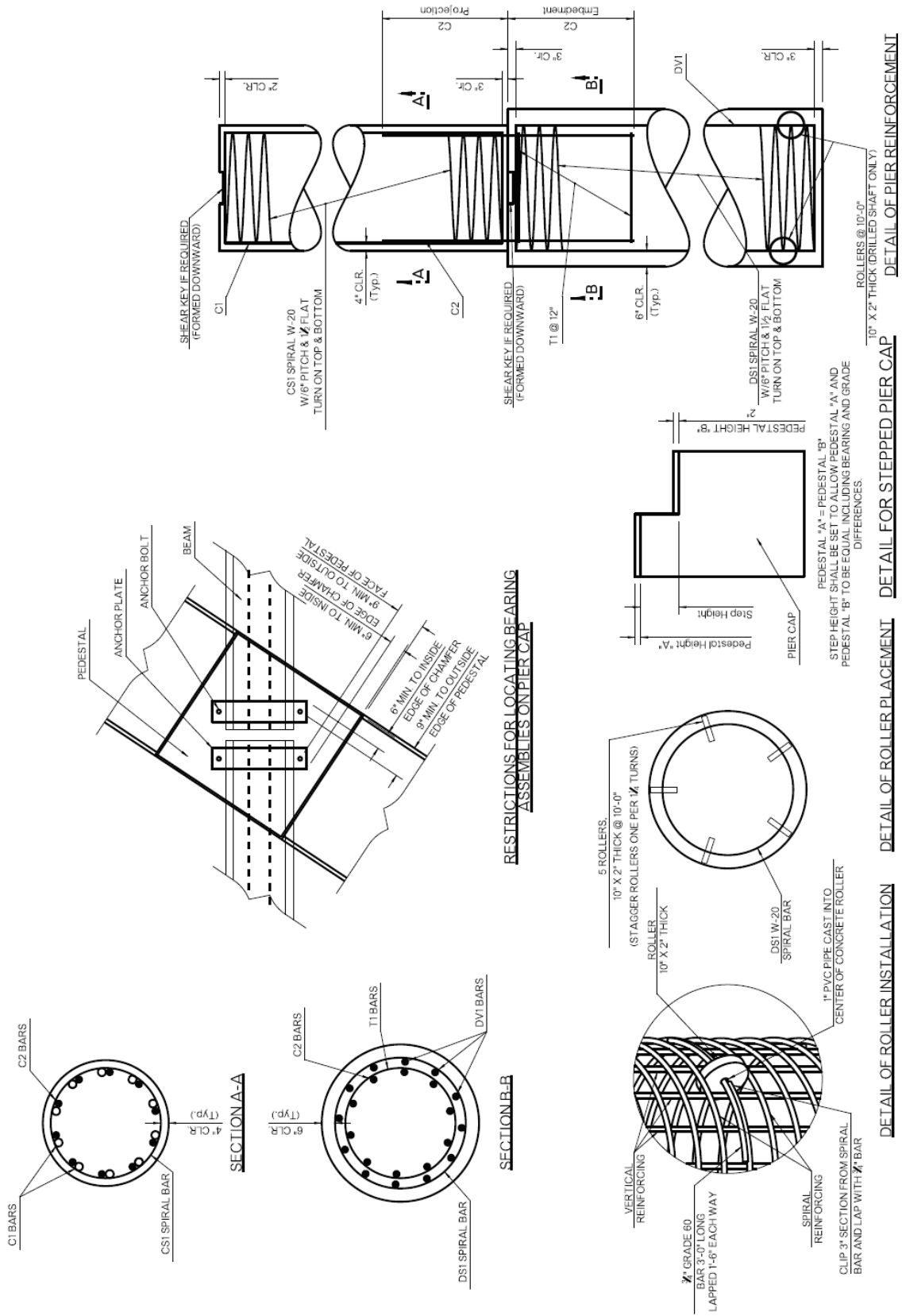
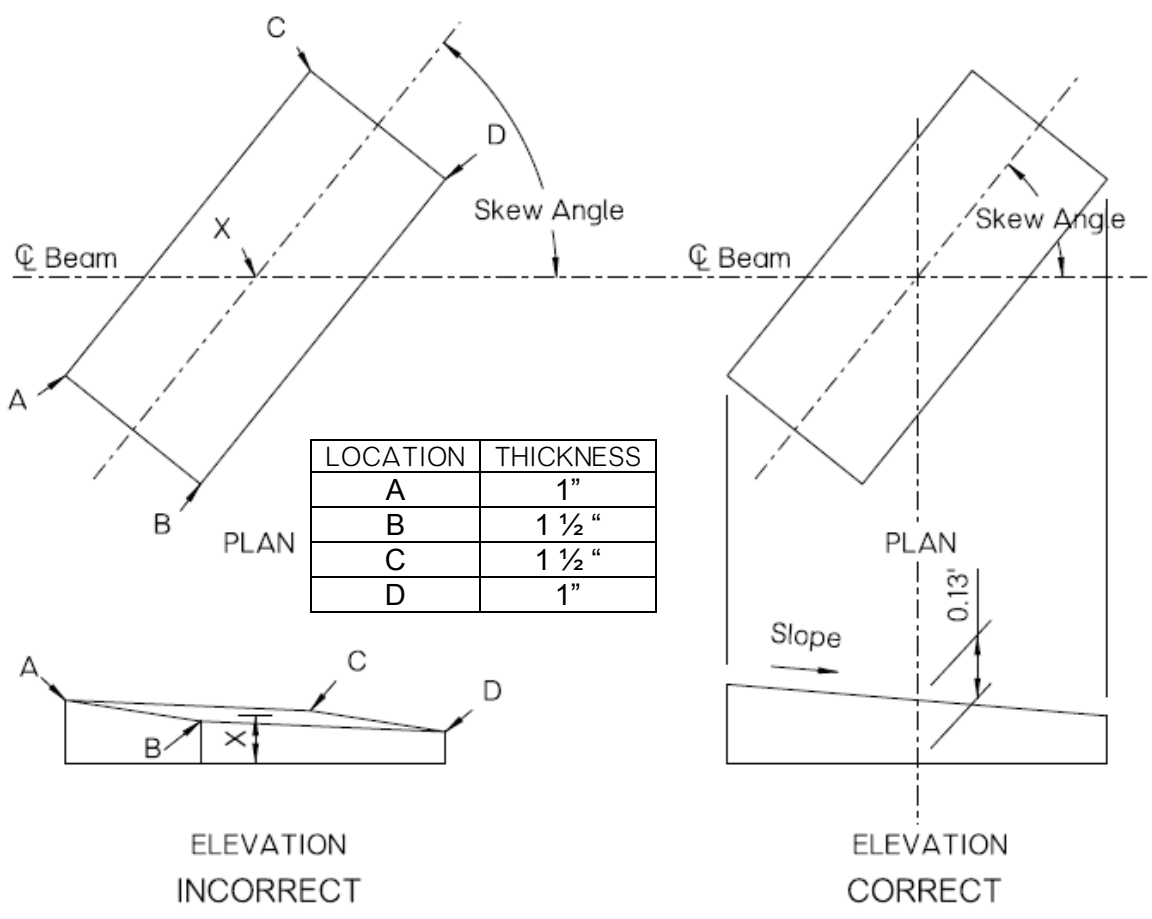
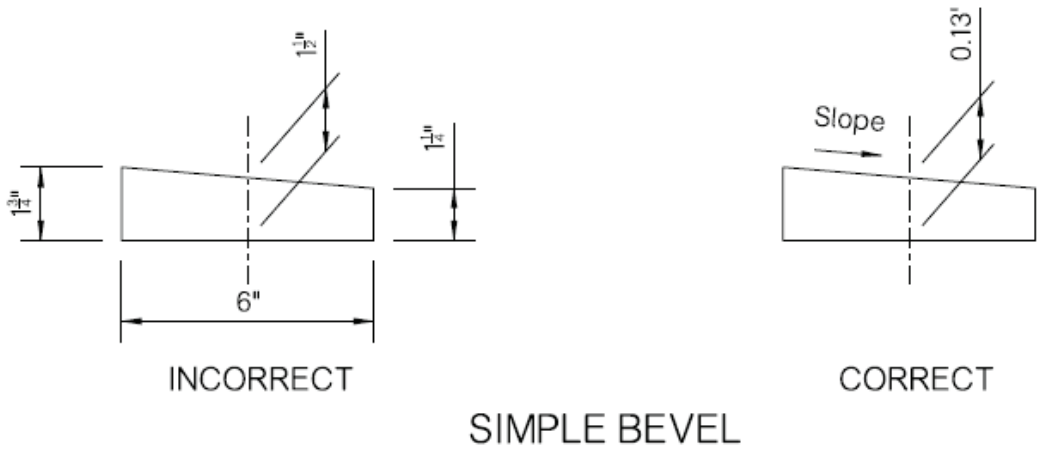

Figure 8 (Pier Detail and Layout Information)

SUPERSTRUCTURE

1. Dimensions tied to the Profile Grade Line and/or Centerline Survey.
2. Details and dimensions of deck, diaphragms, parapet/traffic rails with openings. Joints in parapet/traffic rails shall match joints in slab. Diaphragms shall be 9" thick. BT and J Beam diaphragms shall be 10" thick.
3. No taper in the bridge deck overhang. Include drip bead.
4. Locate all fixed and expansion bearing locations.
5. The actual haunch height is to be calculated by the contractor, and verified by the Engineer. For steel plate girders, the estimated haunch concrete quantity in the Plans shall be calculated based on full height of haunch at centerline bearing for full length of haunch between end diaphragms. For prestressed concrete and rolled steel beams, the estimated haunch concrete quantity in the Plans shall be calculated based on half height of haunch at centerline bearing for full length of haunch between end diaphragms.
6. The estimated haunch depth at the centerline of bearing shall be shown in the Plans. The haunch depth shown for rolled steel and prestressed concrete beams shall measure from top of flange to bottom of deck. For plate girders, the haunch shall measure from top of web to bottom of deck, also, the Design Engineer shall account for camber tolerances allowance for fabrication (according to AWS D1.5, Section 3.5) in the designed haunch. This is to ensure that excessive negative haunches do not occur in the field.
7. Dimension from top of slab to bottom of bearing assembly at centerline bearing.
8. Plan view of deck reinforcing for skewed bridges.
9. Locate expansion joint devices.
10. Epoxy coat all deck reinforcing and any reinforcing projecting into the deck.
11. Slab pouring sequence if required (provided by the Design Engineer).

12. Longitudinal deck reinforcing shall continue through fixed locations for all bridge types. Conventional bridges shall have a cold poured joint over the pier and not a continuous pour (unless otherwise specified by the Design Engineer). Do not place reinforcing laps at the pier. Integral bridges shall have a closure pour directly over the pier and shall have a slab pouring sequence, the joints at the panel ends shall be a cold pour. Do not saw and seal these joints.
13. Diaphragm bolt details.
14. Bearing assembly (including contact plates, angles, beveled anchor plates, and oversized slots in anchor plates, all to be provided by the Design Engineer if needed).
 - a. Bevel of anchor plate shall be calculated by the Design Engineer.
 - b. Plan note shall be included stating the thick edge to be painted red.
 - c. Orientation of plates to be shown.
 - d. See detail ([Figure 9](#)) for method of showing beveled plate.
15. Minimum 1½" thick anchor plates except for integral abutments which shall have 1" thick x 6" wide anchor plates at the abutment. When plates are beveled, thin edge shall be a minimum of 1".
16. Use ⅜" weld between anchor plate and encased sole plate.
17. The gap left in the end diaphragm at the anchor plate location on integral abutments shall be filled with silicone sealant.
18. Edge of slots or holes in anchor plates shall be minimum 1" from edge of anchor plate in the transverse direction and minimum 1½" in the longitudinal direction.
19. Minimum 1½" diameter anchor bolts set minimum 15" into concrete. For integral abutments use 1½" diameter reinforcing bars with deformation removed from protruding portion.
20. Penetrating water repellent treatment of concrete surfaces shall be applied to the following:
 - a. Traffic Rail or Parapet.
 - i. Roadway face.
 - ii. Top face.
 - iii. Interior of traffic rail openings.
 - iv. Top of deck slab under traffic rail openings.
 - b. Outside edge and bottom of overhang portion of deck slab.
 - c. Exterior face and bottom of exterior concrete beams.
21. Reinforcing bar bends.
22. Reinforcing bar list. Round all bars down to the nearest 1".
23. Quantity box.
24. Temperature Expansion Chart as calculated by the Design Engineer.



Note: Show only centerline thickness (to 2 decimal places) and slope of bevel. Do not show corner thicknesses as they may not match exact dimensions. Design Engineer shall determine minimum thickness and slope of plate.

Figure 9 (Beveled Anchor Plate)

PRESTRESSED CONCRETE BEAM

1. Details and dimensions of beams.
2. Interface shear or haunch reinforcing bars shall be epoxy coated and the projection lengths shown (may vary).
3. An elastomeric pad shall be placed on top of prestressed concrete beam ends at piers for integral bridges.
4. Beam dead load deflection shown at tenth points from centerline bearing to centerline bearing.
5. Embedded sole plate must be 4" larger than anchor plate to provide approximately 2" construction tolerance.
6. Details of embedded sole plate and top plate for expansion device connection.
7. Reinforcing bar bends.

STRUCTURAL STEEL

1. Details and dimensions of beams including shear connectors, all stiffeners, diaphragms, field splices, welding symbols/call-outs, and tension and compression locations.
2. Layout of diaphragm locations.
3. Detail of alternate welded splice.
4. Beam dead load deflection shown at tenth points.
5. For plate girders, Blocking Diagrams are not provided in the plans. However, the finished grade elevations at tenth points for each span shall be provided in the plans.
6. Clipped corner detail, at stiffeners, showing weld terminating $\frac{3}{8}$ " + or - $\frac{1}{8}$ " from clipped corner.
7. Show all field welds with appropriate symbology.
8. All steel designations shall be AASHTO instead of ASTM if possible.
9. All structural steel shall be unpainted weathering steel unless otherwise specified by the Design Engineer.
10. Detail fillet welds deposited on opposite sides of common plane of contact between two parts being terminated at a corner by a distance of $\frac{3}{8}$ " + or - $\frac{1}{8}$ ".

APPROACH SLAB

1. All bearings, skew angles, Begin/End approach slab stations, and details/dimensions of approach slabs.
2. Reinforcing layout in the approach slab including embedded parapet/traffic rail reinforcing.
3. A 3/8" wide, 2" deep sawed and sealed longitudinal joint shall be placed between driving lanes, refer to Roadway Standard LECS-4 for additional details.
4. Bridge railing shall be attached to approach slab and shall extend the full length of the approach slab. SR/FS bars shall be included in the price bid per S.Y. of Approach Slab.
5. Quantity box.
6. Reinforcing bar list.
7. Reinforcing shall be epoxy coated.

CONVENTIONAL BRIDGES

1. The standard length of approach slab shall be 30'-0". When the approach slab exceeds 30' in length, provide transverse controlled crack joints 3/8" wide, 2" deep, sawed and sealed. Refer to Roadway Standard [LECS-4](#) for additional details.
2. Seal between wing and approach with 1" wide rapid cure isolation joint, refer to Roadway Standard [LECS-4](#) for details. Cost shall be included in the price bid per S.Y. of Approach Slab.

INTEGRAL BRIDGES

1. The length of approach slab shall depend on the beam length. For more details, see Bridge Standard [B40-I-AS](#).
2. If a two-pour approach slab is to be constructed (with transverse joint), an expansion joint shall be placed between the two sections. The joint size shall be determined by the expansion of the bridge and shall have rapid cure sealant. Detail the joint similar to the expansion joint found on Roadway Standard [LECS-4](#) with the exception of rounding the edges of the concrete 1/2" and recessing the sealant to the bottom of the rounded edge.

3. The traffic rail opening at the expansion joint locations shall have the same opening size as the approach slab and shall be filled with expansion material as shown on the standard; except as follows:
 - a. Traffic Rail
 - i. Recess the expansion material in the roadway face of the post $\frac{1}{2}$ " deep for the full height of the post.
 - b. Parapet
 - i. Recess the expansion material in the roadway face of the parapet $\frac{1}{2}$ " deep for the bottom 1'-1" of the parapet.
 - c. The recess shall be filled with silicone expansion joint filler with non-sag characteristics.
4. Seal between wing and approach with 1" wide rapid cure isolation joint, refer to Roadway Standard [LECS-4](#) for details. Cost shall be included in the price bid per S.Y. of Approach Slab.
5. Reference to Roadway Standard [CRCP-2](#). (Only for concrete paving)

RIPRAP / SLOPE WALL / GABIONS

1. Plan and Elevation views showing
 - a. North Arrow.
 - b. Contours.
 - c. Fill and/or excavation.
 - d. Placement of riprap, concrete slope wall, or gabions.
 - e. Include slope angles.

2. For riprap shapes and placement, see Figures [2 and 3](#) of these Directives. Riprap shall not be placed on or beyond pier.

3. Type and depth to be determined at Plan-in-Hand meeting or by hydraulics requirements.

4. Quantity of riprap and filter blanket to be carried in tons.
 - a. Riprap 110 lbs/C.F. = 1.49 Tons/C.Y
 - b. Filter Blanket 105lbs/C.F. = 1.42 Tons/C.Y.
 - c. TBSC (Type D) 120lbs/C.F. = 1.62 Tons/C.Y

5. Notes and quantity box.

Slopedwalls shall be placed on all grade crossings and rail road crossings. Wrap the header sufficiently to prevent erosion from runoff of the roadway/bridge deck. Slope wall should extend past the bridge deck sufficiently, beyond the “shadow” of the bridge where vegetation will not grow as readily. Extending the slope wall to this point will mitigate erosion from the runoff.

REINFORCED CONCRETE BOX

1. General plan and elevation (Refer to [General Plan and Elevation of these Plan Directives](#)) and include inlet and outlet flowline elevations. In order to show more of the channel, the GP&E shall utilize two sheets; one for Plan, the other for Elevation, details and design.
2. Details and dimensions of RCB including section through barrel and curbs and any wing details if needed.
3. For calculating barrel length, the following criteria shall be used:
 - a. Roadway Typical Sections must be used to determine barrel length. When multiple slopes are shown outside of Clear Zone, the fill height shall be determined using the channel flow line elevation.
 - b. Headwalls shall be placed no closer to the roadway than Clear Zone unless otherwise specified by Design Engineer. Roadway Design Division shall provide Clear Zone dimension.
 - c. Round barrel length up (between headwalls) to the nearest 1ft, normal to the roadway for skewed and non –skewed RCBs.
4. Maximum head wall height shall be 1'-6" unless otherwise instructed. Minimum head wall height shall be 6" if Clear Zone dictates barrel length.
5. Plan and section views of additional curtain walls. Use 4' curtain wall unless otherwise directed by Hydraulics Branch or as necessitated by anticipated degradation.
6. Location and dimensions of head wall removal for RCB extensions. ([see Figure 10](#))
7. Reinforcing bar bends.
8. Minimum of 2' of fill including the design typical section must be placed on top of the barrel for standard design. For less than 2' of fill, Standard drawings may not be used.
9. Reinforcing bar list. Round all bar lengths down to the nearest 1". For "at grade" boxes and wing walls with stubbed in pipes, reinforcing steel shall be epoxy coated.
10. Quantity box.

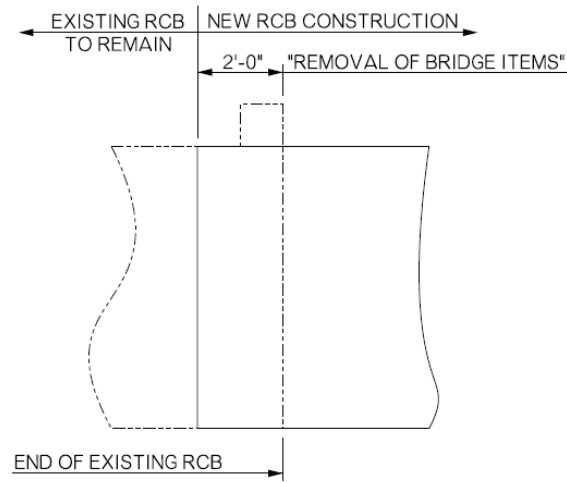

RCB EXTENSION WITH 2'-0"
REMOVAL OF EXISTING BARREL

Figure 10 (Removal of Existing Head Wall)

(2'-0" minimum removal shown; however, removal may be increased due to a damaged end section)

MISCELLANEOUS

1. The approved font is OkDOT. All text on the plan sheets shall be in capital letters. All dimensions, symbols or glyphs shall also be from OkDOT.ttf
2. Text size used on the plan sheet shall conform to the below:
 - a. 120: Standard, dimension, notes, and bridge description.
 - b. 140: Sub View, Sub Title, and note title (bold).
 - c. 175: Titles, Views, emphasized text (typically underlined) (bold).
 - d. 200: Sheet Name (bold).
3. Bridge Division Standard Cell Library shall be used for details/call outs which are standardized.
4. Plan sheet dimension accuracy shall be to an 1/8", unless otherwise directed by the Design Engineer.
5. Final stations, elevations and dimensions shall be rounded. As a note, reinforcing bar lengths shall be rounded down to the nearest inch, and Drilled Shaft lengths are rounded up. Further, reinforced concrete box barrel lengths shall be rounded to the next foot unless right-of-way or design requirements override this directive.
6. Sheet nomenclature:
 - a. File Names shall be named as such: (do not use underbars or hyphens)
 - i. 2710504 GENERAL PLAN AND ELEVATION.dgn
 - ii. 2710504 404 APPLICATION.pdf
 - iii. 2710504 BRIDGE PLAN SUBMISSION LETTER.pdf
 - b. Sheet Numbers for Bridge Division Plan Sheets shall start with "B" followed by the sheet number.
 - i. B001 (with the 1 increasing in sheet count)
 - c. Bridge General Notes and Summary of Pay Quantity Sheets shall be numbered as such:
 - i. AB01 (with the 1 increasing in sheet count)
 - d. Title Sheets and Typical Section Sheets are to be numbered accordingly:
 - i. 0001 (with the 1 increasing in sheet count)

7. The Index of Sheets Sheet Numbers shall be alphabetized.

0001	TITLE SHEET
0002	TYPICAL SECTION SHEET 1
0003	TYPICAL SECTION SHEET 2
AB01	GENERAL NOTES AND SUMMARY OF PAY QUANTITIES (BRIDGE)
AR01	GENERAL NOTES AND SUMMARY OF PAY QUANTITIES (ROADWAY)
AT01	GENERAL NOTES AND SUMMARY OF PAY QUANTITIES (TRAFFIC)
B001	... BRIDGE DIVISION SHEETS...
E001	... ENVIRONMENTAL SHEETS
R001	... ROADWAY DIVISION SHEETS ...
S001	... SURVEY SHEETS ...
T001	... TRAFFIC SHEETS ...
X001	... CROSS SECTIONS ...

8. The Bridge Division Microstation Workspace shall be used for the development of all Bridge Division Plan Sheets.

QUANTITY ROUNDING POLICY

The following is the Bridge Division policy on rounding quantities during plan production. All quantities shown in the plans will reflect a rounded quantity.

Reinforcing Steel (All)	Up to next 10 LBS.
Structural Steel (All)	Up to next 10 LBS.
Asphalt Concrete Class C	Up to next 0.10 Tons
Filter Blanket (All)	Up to next 5 Tons
Riprap (All)	Up to next 10 Tons
Concrete Class A or Class AA	Up to next 0.10 C.Y.
CLSM (Low Strength Backfill Material)	Up to next 0.10 C.Y.
Structural Excavation Unclassified	Up to next 1 C.Y.
Substructure Excavation Rock	Up to next 1 C.Y.
Pipe Underdrain Cover Material	Up to next 1 C.Y.
Trench Excavation	Up to next 1 C.Y.
Standard Bedding Material	Up to next 1 C.Y.
Granular Backfill	Up to next 1 C.Y.
Unclassified or Select Borrow	Up to next 5 C.Y.
Substructure Excavation Common	Up to next 5 C.Y.
Clay Plating	Up to next 5 C.Y.
Unclassified Excavation	Up to next 10 C.Y.
Expansion Devices (All)	Up to next 0.01 L.F.
Prestressed Concrete Beam (All)	Up to next 0.01 L.F.
Bridge Railing (All)	Up to next 0.10 L.F.
Piling (All)	Up to next 1 L.F.
Drilled Shaft (All)	Up to next 1 L.F.
Pipe (All)	Up to next 1 L.F.
Concrete Sawing and Routing	Up to next 1 L.F.
Concrete Surface Repair	Up to next 1 S.F.

Substructure Concrete Repair	Up to next 1 S.F.
Sealer Resin	Up to next 0.1 GAL
Sealer Crack Preparation	Up to next 1 L.F.
Sealer Resin, Above Water	Up to next 0.1 GAL
Preparation of cracks, Above Water	Up to next 10 L.F.
Approach Slab	Up to next 0.10 S.Y.
Bridge Floor Overlay	Up to next 1 S.Y.
Slope Wall	Up to next 1 S.Y.
Special Concrete Finish	Up to next 1 S.Y.
Removal of Pavement	Up to next 1 S.Y.
Removal of Existing Slab	Up to next 1 S.Y.
Sand Cushion	Up to next 1 S.Y.
Penetrating Water Repellant	Up to next 1 S.Y.
Bridge Floor Repair Type A	Up to next 10 S.Y.
Bridge Floor Repair Type B	Up to next 10 S.Y.
Bridge Floor Repair Type C	Up to next 5 S.Y.
Beam Type Guardrail (All)	Multiples of 12'-6"

BRIDGE PLAN DIRECTIVES VERSION HISTORY

DATE	VER NO.	PAGE NO.	MODIFICATION
6-30-16	1.1	1	Changed Signature Block; increased Version Number
6-30-16	1.1	2	Changed Signature information
6-30-16	1.1	16	Revised item 8 to include conventional structure pile note
6-30-16	1.1	32	Added item 5 to Ref. RDY. STD. CRCP-2
6-30-16	1.1	36	Revised item 9 for at grade boxes
12-06-16	1.2	11	Revised Index of Sheets to include new nomenclature
12-06-16	1.2	20	Revised not to include Skewed Expansion Dim. At Abut.
1-30-17	1.2	--	Revised Forward
1-30-17	1.2	9	Revised item 12 to read "if applicable"
1-30-17	1.2	10	Revised item 3 "or", and 6 to read "..and "rock" line
1-30-17	1.2	11	Revised item 2 to read "Vertical Profile Data", 4 and 5
1-30-17	1.2	12	Fixed typo in title (design/foundation data example)
1-30-17	1.2	13	Changed Example title to "Vertical Profile Data"
1-30-17	1.2	14	Revised notes "may be shown at engineer's discretion"
1-30-17	1.2	16	Revised item 3 "offset DIMENSION of profile ..."
1-30-17	1.2	18	Revised item 1 "basis", 2 "perpendicular", 6, 10 and 13
1-30-17	1.2	19	Revised notes "widest beam flange"
1-30-17	1.2	21	Revised item 5, 6 "discretion of Design Engineer" and 7
1-30-17	1.2	23	Revised item 2 "for typical RCB"
1-30-17	1.2	24	Revised item 3, 5, 7, 8 and 9
1-30-17	1.2	25	Revised item 19 and 20
1-30-17	1.2	27	Revised item 6 "engineer shall ACCOUNT FOR" and 11
1-30-17	1.2	28	Revised item 12, 14 and 24
1-30-17	1.2	29	Revised note "DESIGN ENGINEER shall determine ..."
1-30-17	1.2	30	Revised item 2 "INTERFACE SHEAR" and 3
1-30-17	1.2	31	Revised item 7 and 9 "unless otherwise specified.."
1-30-17	1.2	32	Revised item 4
1-30-17	1.2	34	Revised item 5 "mitigate"
1-30-17	1.2	35	Revised item 3b, 5 and 8

1-30-17	1.2	38	Added Environmental Sheets
---------	-----	----	----------------------------