

OKLAHOMA HEALTH CARE AUTHORITY
REGULAR BOARD MEETING
January 17, 2024, at 2:00 P.M.
Oklahoma Health Care Authority
4345 N. Lincoln Blvd.
Oklahoma City, OK. 73105

AGENDA

Public access via Zoom:

https://www.zoomgov.com/webinar/register/WN_zL1lp6WPR6yhGMfQXRJgOg

Telephone: 1-669-216-1590 Webinar ID: 161 301 6252

*Please note: Since the physical address for the OHCA Board Meeting has resumed, any livestreaming option provided is provided as a courtesy. Should such livestreaming option fail or have technical issues, the OHCA Board Meeting will not be suspended or reconvened because of this failure or technical issue.

1. Call to Order / Determination of Quorum.....Marc Nuttle, Chair
2. Discussion and Vote on the December 7, 2023, OHCA Board Meeting Minutes.....Marc Nuttle, Chair
3. Chief Executive Officer Report (Attachment "A").....Ellen Buettner, Chief Executive Officer
 - a) Member Moment
4. State Medicaid Director Report (Attachment "B").....Traylor Rains, State Medicaid Director
5. Chief of Staff Report.....Christina Foss, Chief of Staff
6. Discussion of Report from the.....Phillip Kennedy
Compliance Advisory Committee Chair, Compliance Advisory Committee
and Possible Action
 - a) Discussion and Possible Vote to Approve the State Plan Amendment Rate Committee Rates pursuant to 63 O.S. Section 5006(A)(2) under OAC 317:1-3-4 (Attachment "C")
 - i. State Plan Personal Care Service Rate Increase
7. Discussion of Report of Strategic.....Marc Nuttle
Planning & Operational Advisory Committee Chair, Strategic Planning & Operational Advisory Committee
 - i. Technology Roadmap Presentation, Steve Miller, Chief Technology Officer (Attachment "D")
8. Discussion of Report of Administrative.....Tanya Case
Rules Advisory Committee and Possible Action Chair, Administrative Rules Advisory Committee
(Attachment "E")
 - a) The following **EMERGENCY** rules were previously adopted by the Board on Sept. 20, 2023, under **EMERGENCY** rule making.
 - i. APA WF # 24-07 Secure Mental Health Transportation (*previously APA WF # 23-13*)
 - ii. APA WF # 24-08 Biosimilar Reimbursement (*previously APA WF # 23-15*)
 - iii. APA WF # 24-09 Continuous Eligibility for Children (*previously APA WF # 23-18*)
 - iv. APA WF # 24-10 Non-Payment of Provider Preventable Conditions (*previously APA WF # 23-08*)

- b) The following **EMERGENCY** rules *were not* previously adopted under **EMERGENCY** rule making and are new to the Board.
 - v. APA WF # 24-01 Opioid Overdose Reversal Agents
 - vi. APA WF # 24-02 Federally Qualified Health Center (FQHC) Substance Use Disorder (SUD) Certification Requirements
 - vii. APA WF # 24-06 Living Choice

- c) The following **PERMANENT** rules *were* previously adopted by the Board and the Governor under **EMERGENCY** rulemaking. These rules *were* revised for **PERMANENT** rulemaking.
 - viii. APA WF # 23-06A&B Transition to SoonerSelect
 - ix. APA WF # 23-20 TEFRA Psychological Evaluations and ICF/IID Level of Care Reevaluations
 - x. APA WF # 23-09 Update Services Exempt from Copayment

- d) The following **PERMANENT** rules *were* previously adopted by the Board and the Governor under **EMERGENCY** rulemaking. These rules *were not* revised for **PERMANENT** rule making.
 - xi. APA WF # 23-01 State Plan Personal Care Services for Expansion Adults, TEFRA Eligible Children and Certain MAGI Populations
 - xii. APA WF # 23-02 IO ESI Self-funded Plans
 - xiii. APA WF # 23-05 SoonerCare Application Timeframe
 - xiv. APA WF 23-10 Doula Services
 - xv. APA WF # 23-11 Private Duty Nursing Reimbursement
 - xvi. APA WF # 23-12 Intermediate Care Facilities Payment Program
 - xvii. APA WF # 23-14 Audio-only Telecommunications Health Service Delivery
 - xviii. APA WF 23-16A&B Minimum Age for Enrollment into ADvantage Waiver
 - xix. APA WF # 23-17 Implement Changes to the Health Information Exchange
 - xx. APA WF # 23-19 Adult Day Health Services Revisions
 - xxi. APA WF # 23-21 Quarterly Payments for Orthodontic Services

- e) The following **PERMANENT** rules *were not* previously adopted and are new to the Board.
 - xxii. APA WF # 23-24 Prosthetic Hearing Implants & Ocular Prosthetics for Adults
 - xxiii. APA WF 23-23 Hospital Services Policy
 - xxiv. APA WF # 23-22 Streamline Behavioral Health Workforce Credentialing
 - xxv. APA WF # 23-25A&B Advantage and State Plan Personal Care Revisions
 - xxvi. APA WF # 23-26 340b Non-compliant Providers
 - xxvii. APA WF # 23-27A&B DDS Updates

9. Discussion and Possible Action.....Marc Nuttle, Chair
 Possible Executive Session as Recommended by the General Counsel and Authorized by the Open Meeting Act, 25 O.S. § 307(B)(4) , To Discuss Confidential Legal Matters Concerning Pending Litigation

10. Adjournment.....Marc Nuttle, Chair

NEXT BOARD MEETING
 March 20, 2024, at 2:00PM
 Oklahoma Health Care Authority
 4345 N. Lincoln Blvd
 Oklahoma City, OK 73105

MINUTES OF REGULAR BOARD MEETING
OF THE HEALTH CARE AUTHORITY BOARD

December 7, 2023

Oklahoma Health Care Authority
4345 N. Lincoln Blvd
Oklahoma City, Oklahoma

Manner and Time of Notice of Meeting: A statutorily required public meeting notice was placed on the front door of the Oklahoma Health Care Authority on December 6, 2023 at 2:00 p.m. Advance public meeting notice was provided to the Oklahoma Secretary of State. In addition to the posting of the statutory public notice, the agency placed its agenda on its website on December 15, 2023 at 8:07 a.m.

Pursuant to a roll call of the members, a quorum was declared to be present, and Chairman Nuttle called the meeting to order at 2:00 p.m.

BOARD MEMBERS PRESENT: Chairman Nuttle, Vice-Chairman Yaffe, Member Case, Member Cruzan, Member Finch, Member Jolley, Member Leland

BOARD MEMBERS ABSENT: Member Christ, Member Kennedy (3:49pm)

ITEM 2 / DISCUSSION AND POSSIBLE VOTE ON THE SEPTEMBER 20, 2023, OHCA BOARD MEETING MINUTES

Chairman Nuttle, OHCA Board Chairman

MOTION: Member Case moved for approval of the September 20, 2023, board meeting minutes, as published. The motion was seconded by Member Leland.

BOARD MEMBERS PRESENT: Chairman Nuttle, Member Case, Member Cruzan, Member Finch, Member Leland

BOARD MEMBER ABSTAIN: Vice-Chairman Yaffe, Member Jolley

BOARD MEMBERS ABSENT: Member Christ, Member Kennedy

ITEM 3 / CHIEF EXECUTIVE OFFICER REPORT

Ellen Buettner, Chief Executive Officer

CEO Buettner invited Melissa Goree to provide a member moment.

CEO Buettner provided an overview of OHCA's Key Principles and update the Board on Key Initiatives and Stakeholder Engagement.

Key Initiatives:

SoonerSelect & PHE - CEO Buettner stated that last week was the beginning for Dental open enrollment. The enrollment system opened without incident and Choice Counseling is running smoothly. The Directed Payment Pre-Prints and contracts have been submitted to CMS and are still waiting for approval. The team is analyzing what risks there are and what needs to be done to mitigate them to ensure a smooth rollout.

Administrative – The Oversight team is now fully staffed, with 20 staff members and about 7 on the Education team. The Education team will help OHCA's internal staff understand what it means to be an oversight organization for this program, how to hold people accountable, how data is analyzed, and making sure that the contracted entities are compliant with the requirements that our contracts and the law put on them. There will also be focus on contracted entity education and provider education on how to make this system work the best. With the transition comes vacant positions and staff splitting their time between two areas. Staff have been incredibly supportive of each other, making this transition run smoothly. The co-location plan is still in progress. Director Harpe contacted CEO Buettner to discuss the option of them moving into the building and as of next week, the Department of Corrections will start moving in. Their partner, Parole Board, will also take a small portion of the building. OHCA is excited to see what kind of agency synergies it will see. CEO Buettner congratulated Carolyn Reconnu-Shoffner and April Anonsen who are not serving as Deputy State Medicaid Directors and Christina Foss, who is serving as the Chief of staff. Lastly, OHCA has been working on two major policy initiatives in partnership with the legislature. OHCA is getting closer to be able to propose language and request those bills to be filed. The first bill is regarding Private Duty Nursing, which would allow non-licensed parents to be compensated

for the care they are providing health care to their child or another individual. The second bill is regarding the reimbursement methodology for nursing facilities. Staff have been working with the Chair of our Health and Human Services Policy Committee and Appropriations Subcommittee, Chairman Paul Rosino. This would propose a methodology that is more sustainable and really compensates nursing facilities for higher levels of care that are needed. Staff have also been preparing for upcoming budget hearings, which will likely be scheduled next month.

CEO Buettner provided a snapshot of OHCA's traction initiatives and recent stakeholder engagements. She also announced that OHCA was named as a 2023 Top Workplace. This is the fourth year OHCA has been awarded as a top workplace.

For more detailed information, see attachment "A" of the board packet.

ITEM 4 / STATE MEDICAID DIRECTOR REPORT

Traylor Rains, State Medicaid Director

Mr. Rains provided a State Medicaid Director Update, which included information on Public Health Emergency Unwinding, SoonerSelect Milestones Achieved, Important Dental Milestones, Important Medical and Children Specialty Program Milestones, Provider Incentive Directed Payment Program, and SoonerCare Operations Update.

For more detailed information, see attachment "B" of the board packet.

ITEM 5 / DISCUSSION OF REPORT FROM THE PHARMACY ADVISORY COMMITTEE AND POSSIBLE ACTION REGARDING DRUG UTILIZATION REVIEW BOARD RECOMMENDATIONS

Corey Finch, Chair, Pharmacy Advisory Committee

Action Item – a) Discussion and Possible Vote Regarding Recommendations Made by the Drug Utilization Review Board Pursuant to 63 O.S. § 5030.3 to Add the Following Drugs to the Utilization and Scope Prior Authorization Program under OAC 317:30-5-77.2(e) (see Attachment "C")

Item:	Drug Name:	Used For:
i.	Lumryz™	Narcolepsy
ii.	Legembi™	Alzheimer's Disease
iii.	Vyjuvek™	Dystrophic Epidermolysis Bullosa
iv.	Brixadi™	Opioid Use Disorder
v.	Xacduro®	Pneumonia
vi.	Curvrior™	Wilson's Disease
vii.	Rebyota™ Vowst™	Clostridioides Difficile Infection (C-Diff)
viii.	Orserdu®	Breast Cancer
ix.	Elevidys	Duchenne Muscular Dystrophy
x.	Jesduvroq™	Anemia due to Chronic Kidney Disease
xi.	Veopoz™	CHAPLE Disease
xii.	Ojjaara	Myelofibrosis

MOTION:

Vice-Chairman Yaffe moved for approval of item 5ai-xii, as published. The motion was seconded by Member Cruzan.

BOARD MEMBERS PRESENT:

Chairman Nuttle, Vice-Chairman Yaffe, Member Case, Member Cruzan, Member Finch, Member Jolley, Member Leland

BOARD MEMBERS ABSENT:

Member Christ, Member Kennedy

ITEM 6 / DISCUSSION OF REPORT FROM THE COMPLIANCE ADVISORY COMMITTEE

Kim Leland, Member, Compliance Advisory Committee

Member Leland asked CFO Aaron Morris to provide the committee update.

Financials – For the quarter ended September 30, 2023, the OHCA's revenues were 1.7% over budget while expenditures were 1% over budget. This gives the agency a positive budget variance of \$13.2 million dollars, which is driven by drug rebate revenues and medical refund revenues, and a small portion is driven by SHOPP revenue and expenditures. The finance team continues to track revenue, specifically expenditures and enrollment as the Public Health Emergency

Unwind continues. Enrollment will play a major role in where OHCA ends this fiscal year, and the team is monitoring that daily and doing a quarterly deep dive of where we stand on cash.

Other Financial Updates – OHCA filed a FY25 Budget Request revision to account for the final FMAP that was received after the initial budget request was submitted to the legislature. The FMAP is going from 67.53% to 67.08%. The decrease in FMAP brings the budget request from \$547 million to \$585 million. The budget was submitted to OMES and the legislature. OHCA also submitted seven Directed Payment Program pre-prints to CMS. Three of the seven, which includes the two hospital programs, have been approved. The remaining four have been submitted but not approved. The team also submitted the Managed Care Capitation Rates to CMS for all three programs, Dental, Medical, and Children's Specialty. OHCA received questions on the Dental Cap Rates from CMS and have responded to those.

Program Integrity Update – For the first quarter of state fiscal year 2024, Clinical Provider Audits, Data Analytics, and Payment Accuracy had a final identified overpayment of \$1,071,897.23 as the result of 271 cases closed with findings.

Member Leland asked Ms. Smith to provide an overview of the below Expenditure of Authority Contracts:

- a) Discussion and Possible Vote regarding the Authority's ability to withstand the procurement decision made by the CEO based on the Authority's budget and available funds pursuant to 63 O.S. Section 5006(A)(2) under OAC 317:10-1-1 (see Attachment "D")
 - i. Customer Relationship Management (CRM)
 - ii. Population Care Management Software System

MOTION:

Member Jolley moved for approval of item 6ai-ii, as published. The motion was seconded by Chairman Nuttle.

BOARD MEMBERS PRESENT:

Chairman Nuttle, Vice-Chairman Yaffe, Member Case, Member Cruzan, Member Finch, Member Jolley, Member Leland

BOARD MEMBERS ABSENT:

Member Christ, Member Kennedy

ITEM 7 / DISCUSSION OF REPORT OF STRATEGIC PLANNING & OPERATIONAL ADVISORY COMMITTEE

Marc Nuttle, Chair, Strategic Planning & Operational Advisory Committee

Chairman Nuttle provided an overview of the topics of discussion from the meeting held in November, which included a FY25 budget update, Chief of Technology Update, particularly the HIE development of a technology roadmap, Operational Metrics, and PHE Unwind. Chairman Nuttle added that discussions on health care and workforce have started within the committee, as well as with the legislature, and Lt. Governor Pinnell, to be able to create a detailed plan to present to the board later.

ITEM 8 / DISCUSSION OF REPORT FROM THE ADMINISTRATIVE RULES ADVISORY COMMITTEE AND POSSIBLE ACTION REGARDING AGENCY RULEMAKING

Tanya Case, Chair, Administrative Rules Advisory Committee

- a) Discussion and Possible Vote on Recommended Rulemaking Pursuant to Article I of the Administrative Procedures Act and in accordance with 75 O.S. § 253. OHCA Requests the Adoption of the Following Emergency Rules (see Attachment "E")

The following EMERGENCY rules HAVE NOT previously been approved by the Board:

- i. APA WF # 23-16A ADvantage Waiver Amendment
- ii. APA WF # 23-16B ADvantage Waiver Amendment
- iii. APA WF # 23-19 Adult Day Health Services Revisions
- iv. APA WF # 23-20 Tax Equity and Fiscal Responsibility Act (TEFRA) Psychological Evaluations and ICF/IID Level of Care Reevaluations
- v. APA WF # 23-21 Quarterly Payments for Orthodontic Services

MOTION:

Member Cruzan motioned to approve the declaration of a compelling public interest for the promulgation of the emergency rules in item 8ai-v. The motion was seconded by Member Leland.

BOARD MEMBERS PRESENT:

Chairman Nuttle, Vice-Chairman Yaffe, Member Case, Member Cruzan, Member Finch, Member Jolley, Member Leland

BOARD MEMBERS ABSENT: Member Christ, Member Kennedy

MOTION: Vice-Chairman Yaffe moved to approve the rule listed in item 8ai-v as published. The motion was seconded by Chairman Nuttle.

BOARD MEMBERS PRESENT: Chairman Nuttle, Vice-Chairman Yaffe, Member Case, Member Cruzan, Member Finch, Member Jolley, Member Leland

BOARD MEMBERS ABSENT: Member Christ, Member Kennedy

ITEM 9 / DISCUSSION AND POSSIBLE ACTION REGARDING OHCA BOARD MEETING DATES AND TIMES FOR CALENDAR YEAR 2024

Marc Nuttle, OHCA Board Chairman

For more detailed information, see attachment "F" of the board packet.

MOTION: Vice-Chairman Yaffe moved for approval of the 2024 OHCA Board Meeting Dates and Times, as published. The motion was seconded by Member Case.

BOARD MEMBERS PRESENT: Chairman Nuttle, Vice-Chairman Yaffe, Member Case, Member Cruzan, Member Finch, Member Jolley, Member Leland

BOARD MEMBERS ABSENT: Member Christ, Member Kennedy

ITEM 10 / DISCUSSION AND POSSIBLE ACTION ON THE ELECTION OF THE OHCA 2024 BOARD OFFICERS

Marc Nuttle, OHCA Board Chairman

MOTION: Member Jolley moved for approval of Marc Nuttle as 2024 OHCA Board Chairman and Alex Yaffe as 2024 OHCA Board Vice-Chairman. The motion was seconded by Member Leland.

BOARD MEMBERS PRESENT: Chairman Nuttle, Vice-Chairman Yaffe, Member Case, Member Cruzan, Member Finch, Member Jolley, Member Leland

BOARD MEMBERS ABSENT: Member Christ, Member Kennedy

ITEM 11 / PROPOSED EXECUTIVE SESSION AS RECOMMENDED BY THE CHIEF OF LEGAL SERVICES AND AUTHORIZED BY THE OPEN MEETINGS ACT, 25 OKLAHOMA STATUTES §307(B) (4).

Marc Nuttle, OHCA Board Chairman

MOTION: Member Jolley moved to go into Executive Session. The motion was seconded by Vice-Chairman Yaffe.

BOARD MEMBERS PRESENT: Chairman Nuttle, Vice-Chairman Yaffe, Member Case, Member Cruzan, Member Finch, Member Jolley, Member Leland

BOARD MEMBERS ABSENT: Member Christ, Member Kennedy

MOTION: Member Case moved to leave Executive Session. The motion was seconded by Vice-Chairman Yaffe.

BOARD MEMBERS PRESENT: Chairman Nuttle, Vice-Chairman Yaffe, Member Case, Member Cruzan, Member Finch, Member Jolley, Member Kennedy, Member Leland

BOARD MEMBERS ABSENT: Member Christ

ITEM 12 / ADJOURNMENT

Marc Nuttle, OHCA Board Chairman

MOTION: Member Jolley moved to adjourn. The motion was seconded by Member Cruzan.

BOARD MEMBERS PRESENT:

Chairman Nuttle, Vice-Chairman Yaffe, Member Case, Member Cruzan,
Member Finch, Member Jolley, Member Kennedy, Member Leland

BOARD MEMBERS ABSENT:

Member Christ

Meeting adjourned at 3:57 p.m., 12/7/2023

NEXT BOARD MEETING
January 17, 2024
Oklahoma Health Care Authority
4345 N. Lincoln Blvd
Oklahoma City, OK 73105

Martina Ordonez
Board Secretary

Minutes Approved: _____

Initials: _____

DRAFT

This page intentionally left blank

SoonerCare

CURE HEPATITIS C INITIATIVE

In March 2023, the Biden Administration announced a national strategic plan to eliminate viral hepatitis as a public health threat in the United States by 2030: **A Roadmap to Elimination**.

Priority Populations¹

Incidence: People who inject drugs, American Indian/Alaskan Native

Prevalence: People who inject drugs, Black, non-Hispanic, people born between 1945-1965, people with HIV

Mortality: American Indian/Alaska Native, Black, non-Hispanic, people born between 1945-1965

Universal Screening Saves Lives⁴

The CDC recommends universal hepatitis C screening for:

- Every person 18+ (at least once)
- All pregnant people (during each pregnancy)
- Every person with risk factors (at least once and periodically if ongoing)

*In settings where prevalence is 0.1% or greater

Medication Coverage⁵

Hepatitis C (HCV) can be CURED in 8 weeks with MAVYRET® for most patients.

MAVYRET (glecaprevir/pibrentasvir) is the only SoonerCare preferred direct-acting antiviral (DAA) medication for HCV and is now available to SoonerCare members without a prior authorization (PA) and does not require a specialist consult!

The American Association for the Study of Liver Disease (AASLD) and Infectious Disease Society of American (IDSA) have developed **HCV Treatment Guidelines**.

All other DAA PA criteria and forms are still in effect for SoonerCare. There are supports in place to assist with specialist consultations, CME and care management for hepatitis C treatment through the **OSU Hepatitis C TeleECHO**.

Did you know?

According to the CDC, hepatitis C rates nearly tripled from 2011-2018!²

In the 2018 surveillance report by the CDC, across the nation there were 3,621 new cases reported, 1.2 cases per 100,000 population, 50,300 acute infections estimated.

In Oklahoma, there are approximately 4,500 SoonerCare members with a diagnosis of hepatitis C that are untreated.³



OKLAHOMA
Health Care Authority

1. *Viral Hepatitis National Strategic Plan Overview (hhs.gov)*
2. *Hepatitis C Surveillance in the United States, 2018 (cdc.gov)*
3. *Chronic Conditions - Hepatitis - SFY2020.pdf (oklahoma.gov)*
4. *HepC_ScreeningRecs_Factsheet.pdf (cdc.gov)*
5. *Mavyret letter final.pdf (oklahoma.gov)*

This page intentionally left blank

MEDICAID DIRECTOR UPDATE

JANUARY 17, 2023



PUBLIC HEALTH EMERGENCY UNWINDING UPDATE



PHE UNWINDING UPDATE

- Final unwinding group last day of coverage December 31
- 267,220 total MAGI denials since May
- The Non-MAGI population will be complete March 31
- Unite Us Outreach
 - 320,745 outreaches to PHE affected members (emails, texts, phone calls);
 - 132,138 connections with PHE affected members,
 - 10,830 care coordination outreaches
 - 1,391 members connected to Care Coordination
 - 1,324 needs identified
 - 88% of cases closed as resolved
 - Top needs addressed include benefits navigation, housing and shelter, food assistance, physical health

SOONERSELECT UPDATE



MILESTONES ACHIEVED

- ✓ Targeted provider townhalls
 - ✓ Oklahoma Dental Association, Osteopathic Association, Behavioral Health Association, Oklahoma Academy of Family Physicians, Alliance of Mental Health Providers of Oklahoma
- ✓ Follow-up onsite visits conducted for LIBERTY Dental and Dentaquest to ensure readiness for go-live.
- ✓ Dental open enrollment closed January 10th and auto-assignment completed January 11th.
 - ✓ Roughly 97,000 individuals selected a dental plan
- ✓ Dental Plans began mailing welcome packets to their assigned members
- ✓ All State Directed Payment PrePrints have been submitted to CMS. OHCA has received the following additional approvals:
 - ✓ Public ambulance service provider
 - ✓ Private ambulance service providers
- ✓ The Go/No-Go milestone was achieved January 9th with the decision made to continue with the planned go-live of April 1, 2024
- ✓ Member enrollment letters began printing January 11th with mailing to begin January 20th.
- ✓ Medical plan [Value Added Benefits Chart](#) posted to SoonerSelect website.
- ✓ OHCA Communications produced a “how-to” [video](#) on selecting a SoonerSelect dental plan through MySoonerCare.org.

IMPORTANT MILESTONES DENTAL

Key Priorities Requiring CMS Approval: SoonerSelect Implementation on February 1, 2024 (*Dental*)

★ Public Comment
★ CMS Submission
★ CMS Approval
★ Additional Milestones (signature, release of documents to CEs)

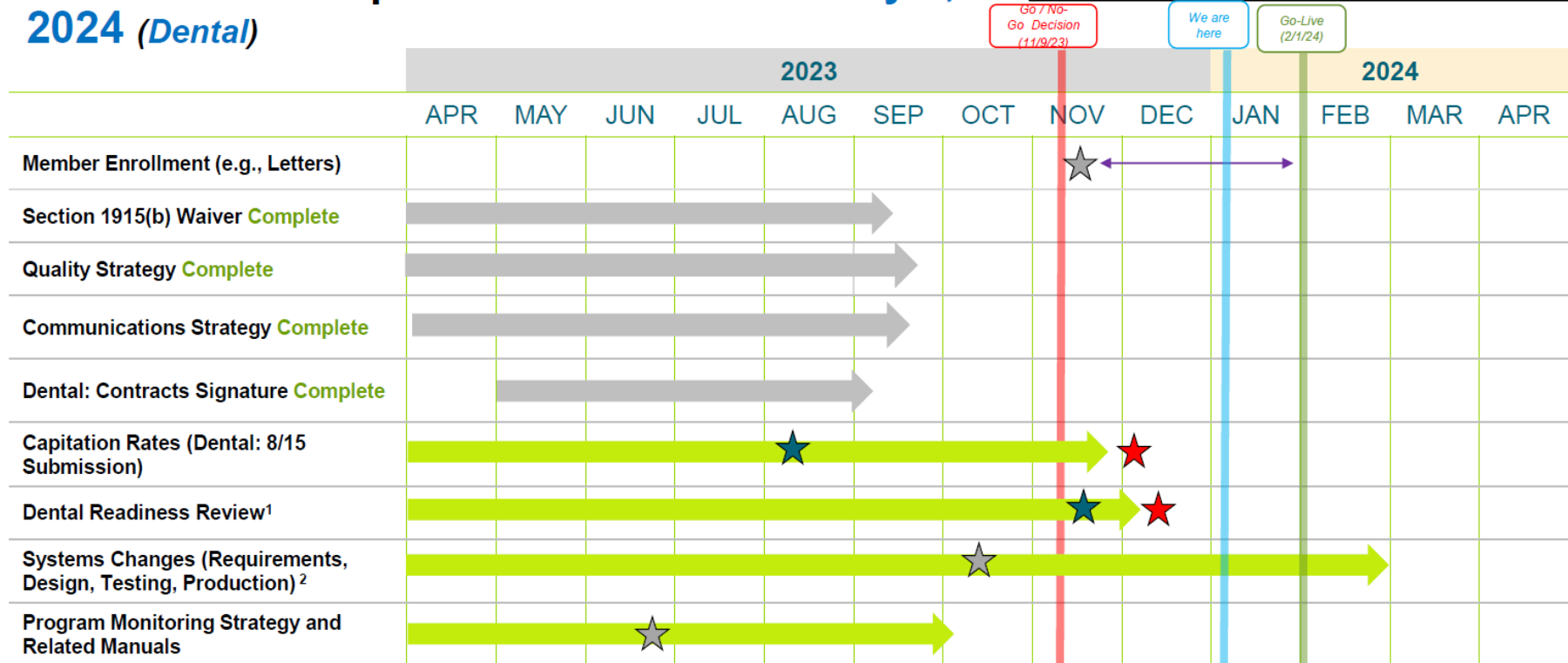

Mailing Enrollment Letters: 11/20/23-11/22/23
Open Enrollment Period: 12/1/23-1/10/24 (40 Days)
Auto-Enrollment: 1/1/24-1/14/24
Continuity of Care: 2/1/24-5/1/24 that provides the option to switch CEs for 90 days

IMPORTANT MILESTONES MEDICAL AND CSP

Key Priorities Requiring CMS Approval: SoonerSelect Implementation on **April 1, 2024** (*Medical and Children's Specialty*)

★ Public Comment
★ CMS Submission
★ CMS Approval
★ Additional Milestones (signature, release of documents to CEs)

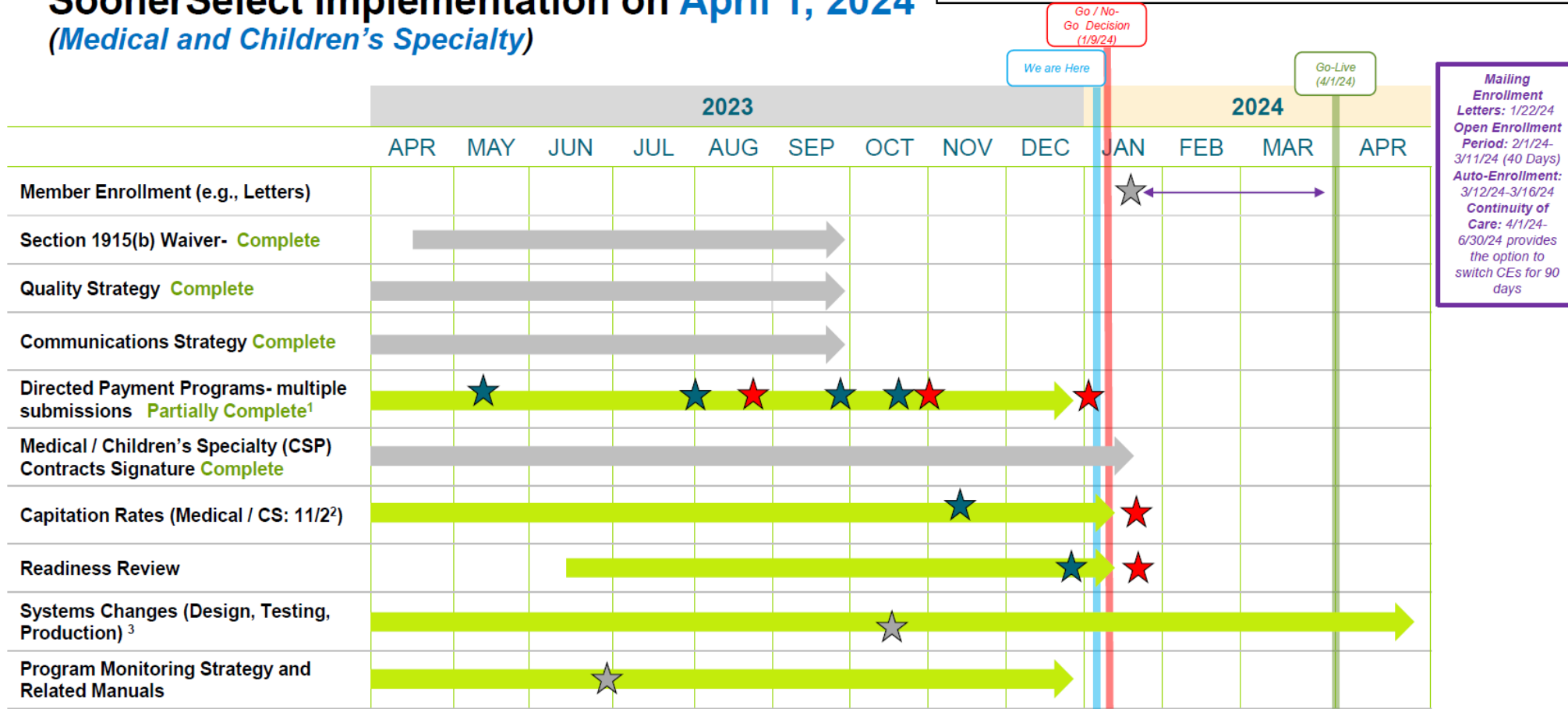

SOONERCARE OPERATIONS UPDATE



QUALITY IMPROVEMENT FLUORIDE VARNISH (QIFV)

- Project aimed at increasing the use of fluoride varnish for children in medical practices, decreasing the incident of dental carries in SoonerCare children, and improving overall health of SoonerCare kids.
- Fluoride varnish can fit into the Well Child checks with little additional time spent and is reimbursed by SoonerCare twice a year for children under age 5.
- Over the past two years, 42 pediatric and family medicine clinics have been enrolled into the QIFV project.
- In 2018 the average SoonerCare clinic fluoride varnish rate was 3%.
- After implementing the QIFC, we are seeing clinics in the project with fluoride varnish rates at and above 40% of well child visits.



OKLAHOMA
Health Care Authority

GET IN TOUCH

4345 N. Lincoln Blvd.
Oklahoma City, OK 73105

oklahoma.gov/ohca
mysoonercare.org

Agency: 405-522-7300
Helpline: 800-987-7767





STATE PLAN AMENDMENT RATE COMMITTEE

STATE PLAN PERSONAL CARE SERVICE RATE INCREASE

1. IS THIS A RATE CHANGE OR A METHOD CHANGE?

Rate Change

2. IS THIS CHANGE AN INCREASE, DECREASE, OR NO IMPACT?

Increase

3. PRESENTATION OF ISSUE – WHY IS THIS CHANGE BEING MADE?

Oklahoma Human Services is seeking to amend the reimbursement rate for the SPPC Nurse Assessment/Evaluation Visit.

This request is to provide a reimbursement rate for the Oklahoma Medicaid-State Plan Personal Care Nurse Assessment/Evaluation Visit to correlate with the corresponding reimbursement rate for the other 1915(c) Waivers. The skill performed is the same whether it is being performed for the ADvantage Waiver, other 1915(c) waivers, or the Oklahoma Medicaid-State Plan Personal Care program.

4. CURRENT METHODOLOGY AND/OR RATE STRUCTURE.

The current rate structure for the SPPC Service provided in the proposed rate change is a fixed and uniform rate established through the State Plan Amendment Rate Committee process.

State Plan Service	Code	Unit Type	Current Rate
State Plan Skilled Nursing - Assessment/Evaluation	T1001	per visit	\$78.00

5. NEW METHODOLOGY OR RATE STRUCTURE.

The new per visit rate is based on the current rate of five (5) units of Skilled Nursing Service, which is the standard provided through 1915 (c) Waivers.

State Plan Services	Code	Unit Type	Current Rate	New Rate
State Plan Skilled Nursing - Assessment/Evaluation	T1001	per visit	\$78.00	\$97.50



STATE PLAN AMENDMENT RATE COMMITTEE

6. BUDGET ESTIMATE.

The estimated budget impact for SFY 2024 will be an increase in the total amount of \$131,625 of which the state share is \$43,000.

Oklahoma Human Services attests that it has adequate funds to cover the state share of the projected cost of services.

7. AGENCY ESTIMATED IMPACT ON ACCESS TO CARE.

The rate increase will have a positive impact on care as providers are able to meet increased labor costs.

8. RATE OR METHOD CHANGE IN THE FORM OF A MOTION.

Oklahoma Human Services requests the State Plan Amendment Rate Committee approve the proposed rate increase.

9. EFFECTIVE DATE OF CHANGE.

January 1, 2024, pending CMS approval.

OHCA 3-year Technology Strategic Plan

CTO Stephen Miller



OKLAHOMA



CTO OBJECTIVES

- Develop 3 Year technology roadmap
- Develop methodology and process for prioritizing technology initiative
- Complete initial assessment for prioritizing technology initiatives
- Develop methodology for ROI assessment and cost justification

1st Half
2024

2nd Half
2024

WHAT IS USABILITY ENGINEERING

Columbia Obstruction Device

Goals are to:

- Maximize the reward
- Minimize the pain

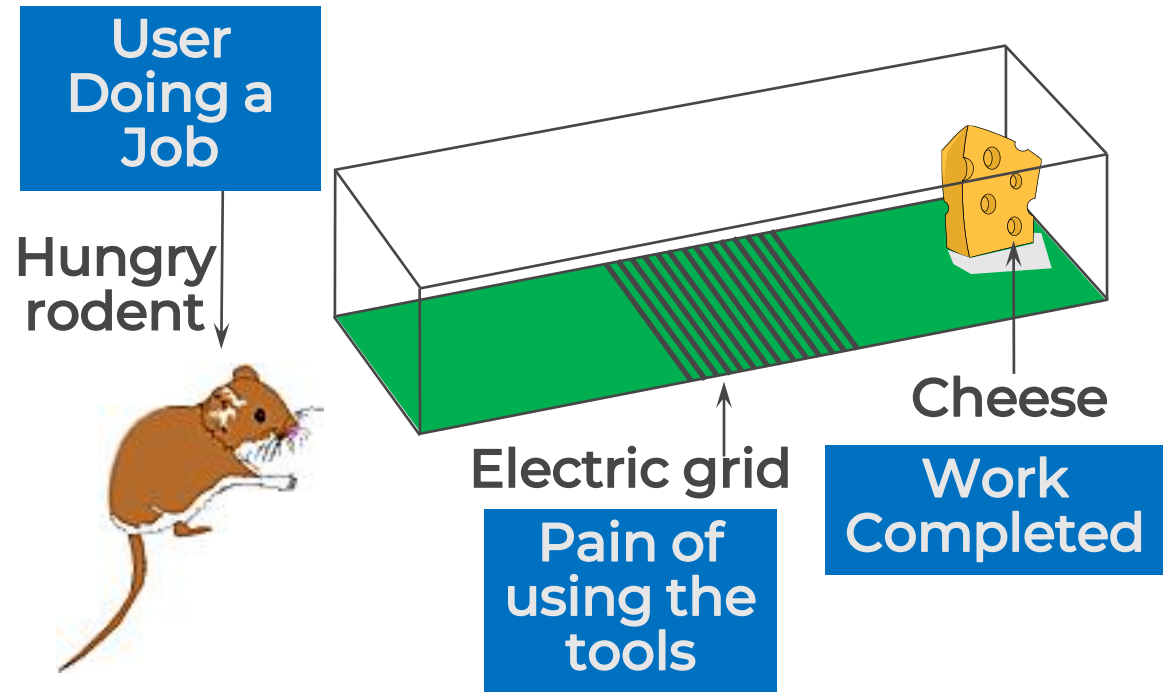
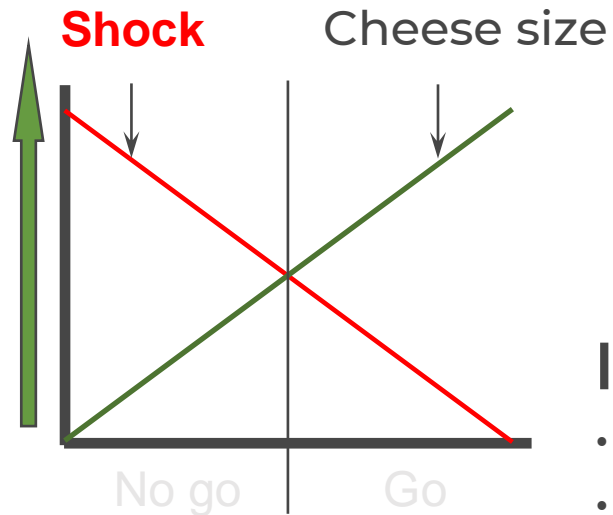

Intersection of Technology & Psychology

- User-centered approach
- Empirical wherever possible
- Performance not Preference

USABILITY ENGINEERING

Usability is the “**effectiveness, efficiency and satisfaction**” with which a specified set of users can achieve a specified set of tasks in a particular environment.”

--International Standards

Organization

A usable product...

- **Is easy to learn**
- **Is hard to forget**
- Minimizes burden
- Reduces workload
- Encourages and rewards experimentation
- Anticipates and forgives mistakes
- Always provides feedback
- Satisfying and, possibly, fun to use
- Does what the user wants –when the user wants it!

shape

highway

SHAPE

HIGHWAY

The FedEx logo, featuring the word "FedEx" in a bold, sans-serif font. The "Fed" is in blue and the "Ex" is in orange. A registered trademark symbol (®) is located at the end of the word.

SHALL I COMPARE THEE TO A SUMMER'S DAY?
THOU ART MORE LOVELY AND MORE
TEMPERATE: ROUGH WINDS DO SHAKE THE
DARLING BUDS OF MAY, AND SUMMER'S LEASE
HATH ALL TOO SHORT A DATE. SOMETIME TO
HOT THE EYE OF HEAVEN SHINES, AND OFTEN IS
HIS GOLD COMPLEXTION DIMM'D. AND EVERY
FAIR FROM FAIR SOMETIMES DECLINES, BY
CHANCE OR NATURE'S CHANGING COURSE
UNTRIMM'D... --SHAKESPEARE

GUIDING PRINCIPLES FOR IT SOLUTIONS

- Ensure solutions start with the end in mind
- ROI understood
- Clear expectation of results / benefits gained
- What problem will it solve and how will we measure success.
- End User Experience Key consideration
 - **Easy to Learn, Hard to Forget**
- Ensure fits in Ecosystem / Reference Architecture.
- Secure and Supportable!

TECHNOLOGY ROADMAP



OHCA 3-YEAR TECHNOLOGY ROADMAP

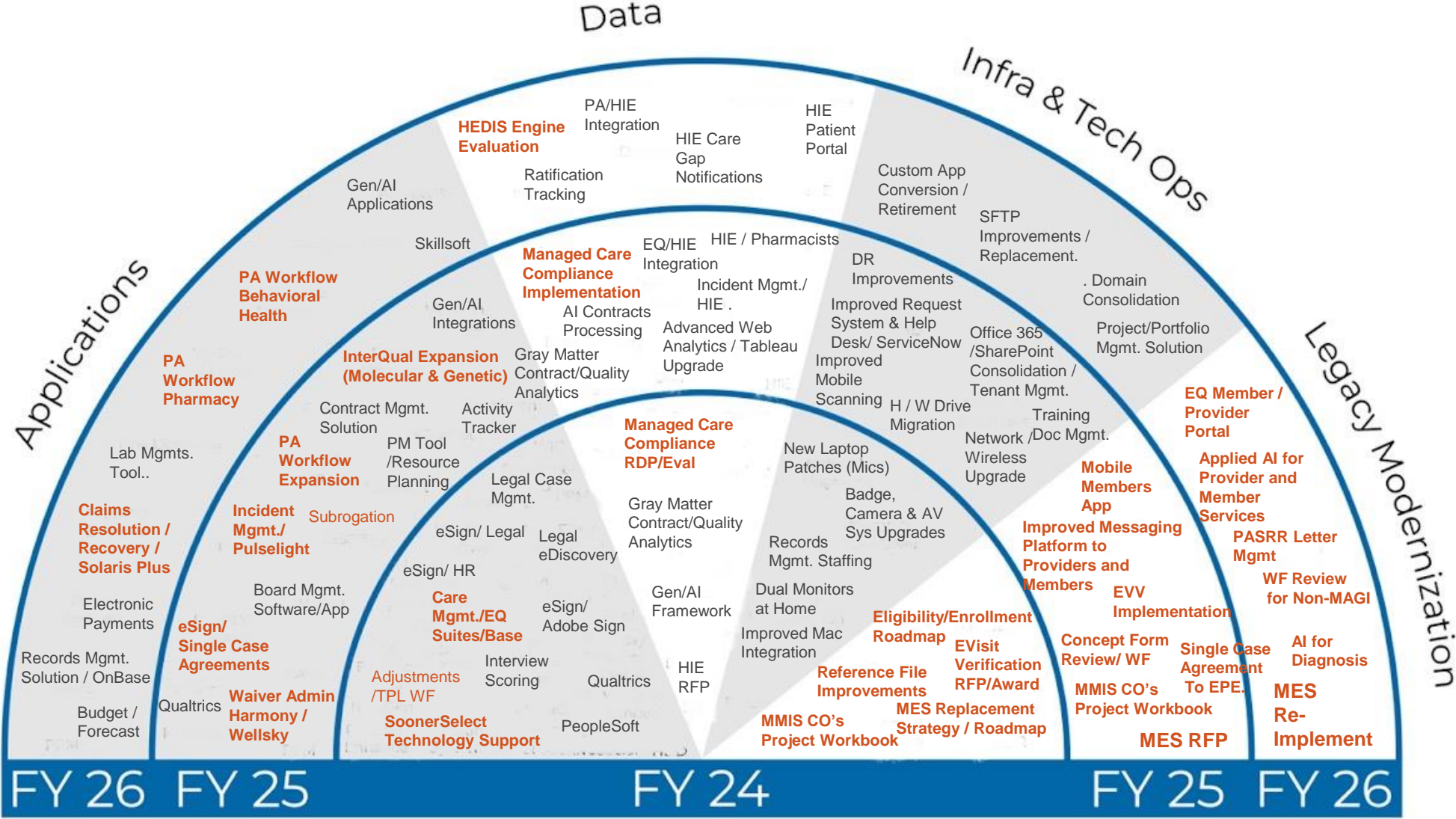

Medicaid Enterprise System Components

CTO OBJECTIVES

✓ Develop 3 Year technology roadmap

- Develop methodology and process for prioritizing technology initiative
- Complete initial assessment for prioritizing technology initiatives
- Develop methodology for ROI assessment and cost justification

1st Half
FY2024

2nd Half
FY2024

IT GOVERNANCE PROCESS

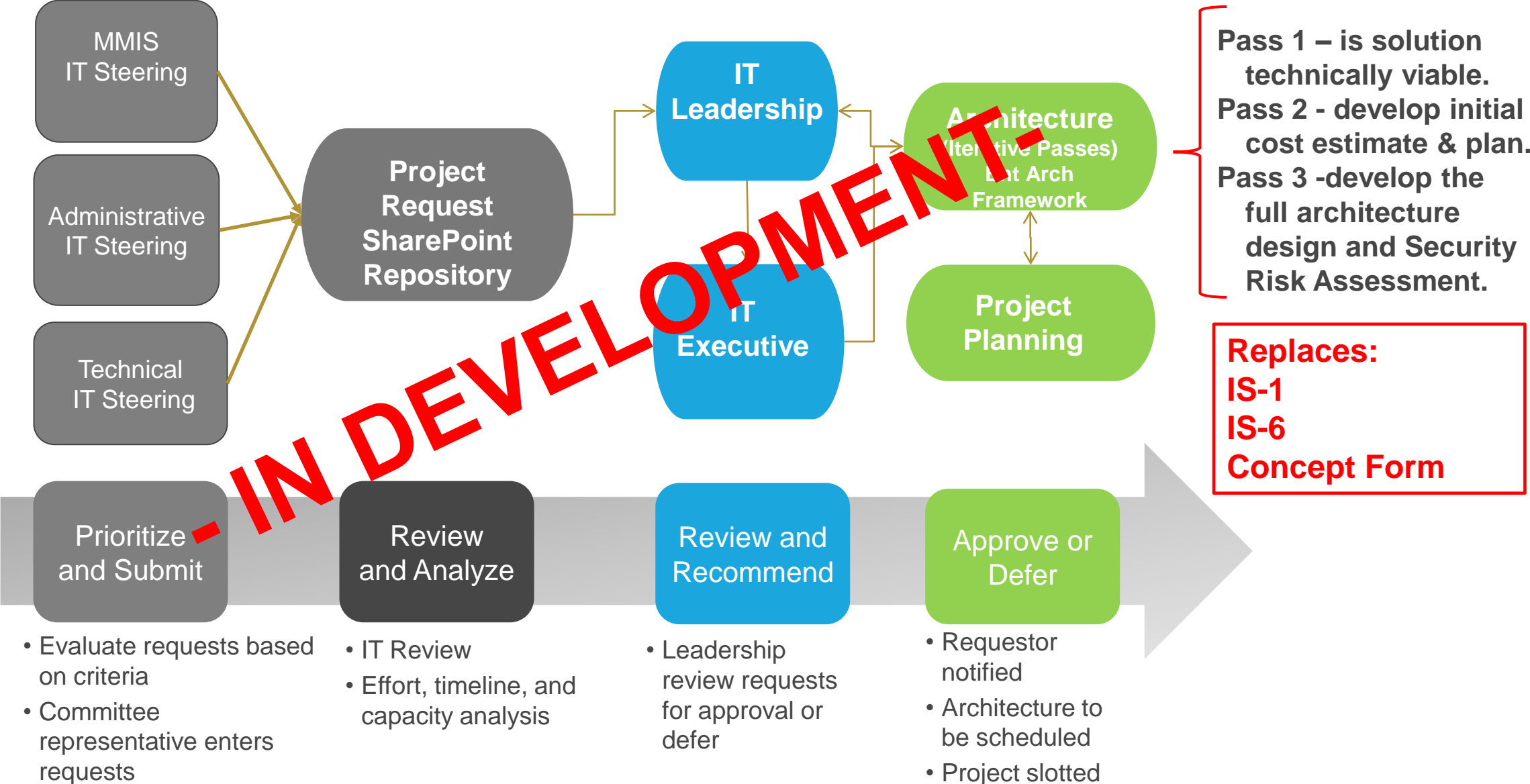

PUSH TOWARDS A DATA DRIVEN CULTURE

Crawl, Walk, Run Methodology

Establish a Data-Driven Culture through a stepped approach

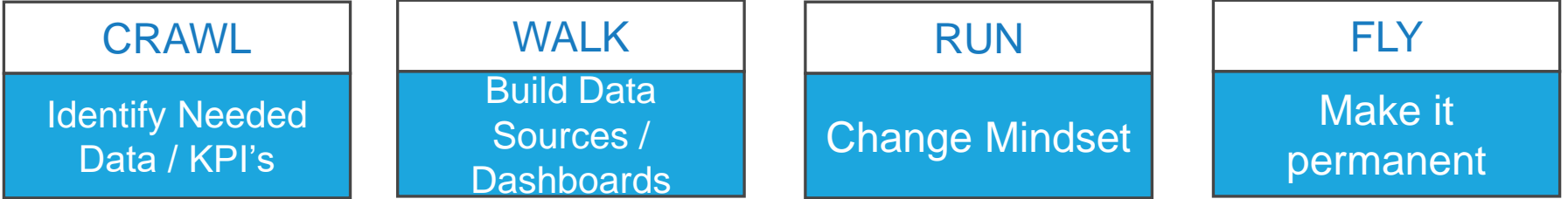

- Define and examine goals with data.
- Set company direction and strategy using data.

- Enable everyone in the organization to use data daily.
- Create analyses with diverse groups of people

- Make all decisions with an evidence-based culture.
- Encourage curiosity in your culture.
- Train everyone in org to use and interpret data accurately.

- Invest in collecting data.
- Constantly improve your data tech stack.
- Know that we will never be finished.

On-Going Monitoring and Improvement

**MEDICAID
ENTERPRISE
SYSTEM
INTEGRATION**



CURRENT MES (Medicaid Enterprise System)

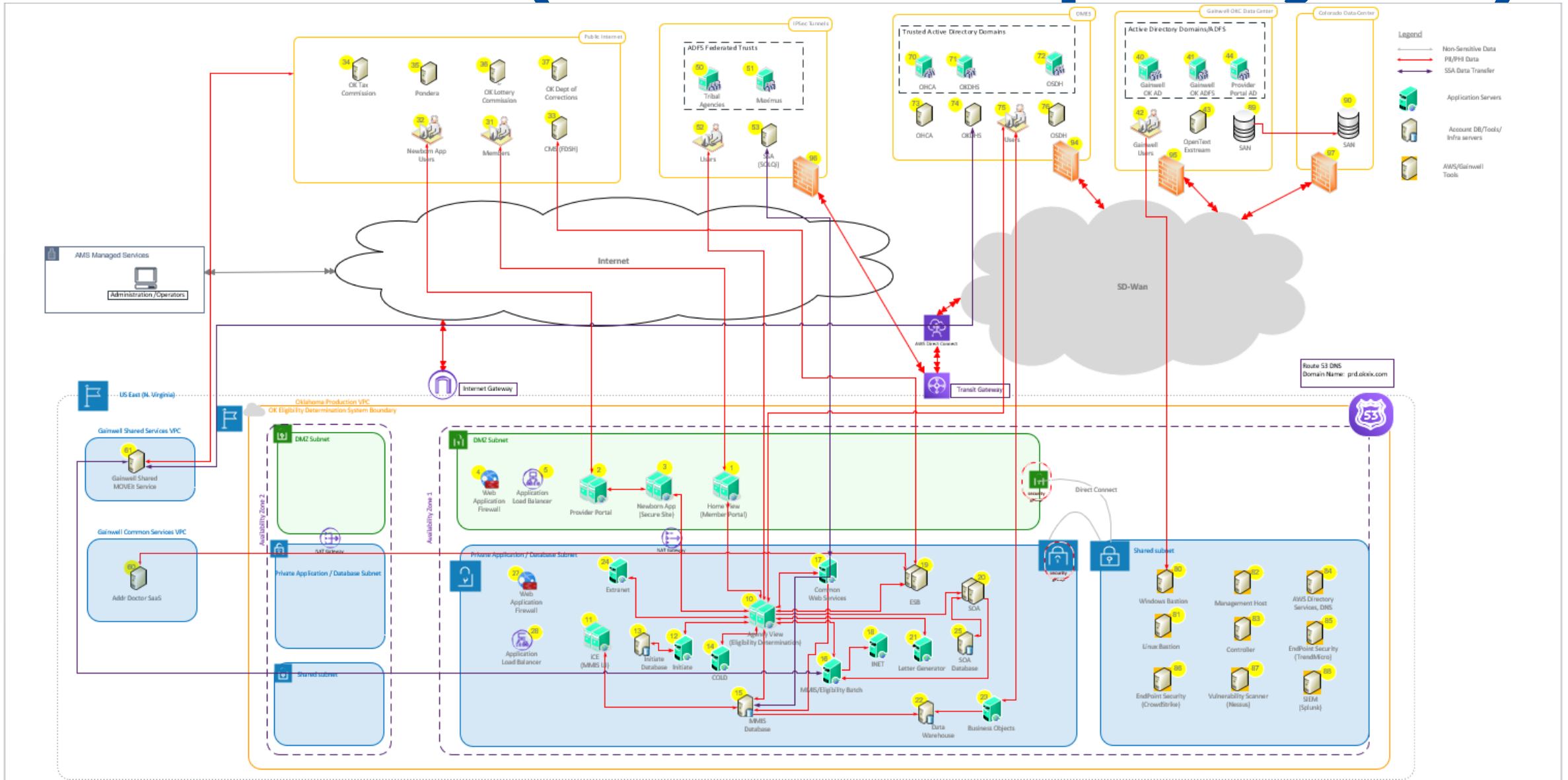

OHCA Strategic Transformation Roadmap

Reimagining the Future of Medicaid

NOTE: This document outlines our approach, timeline and team for Phase 1, Strategy and Planning

Engagement Term: Start 11/21/2023 | End 4/26/2024

1 Strategy and Planning

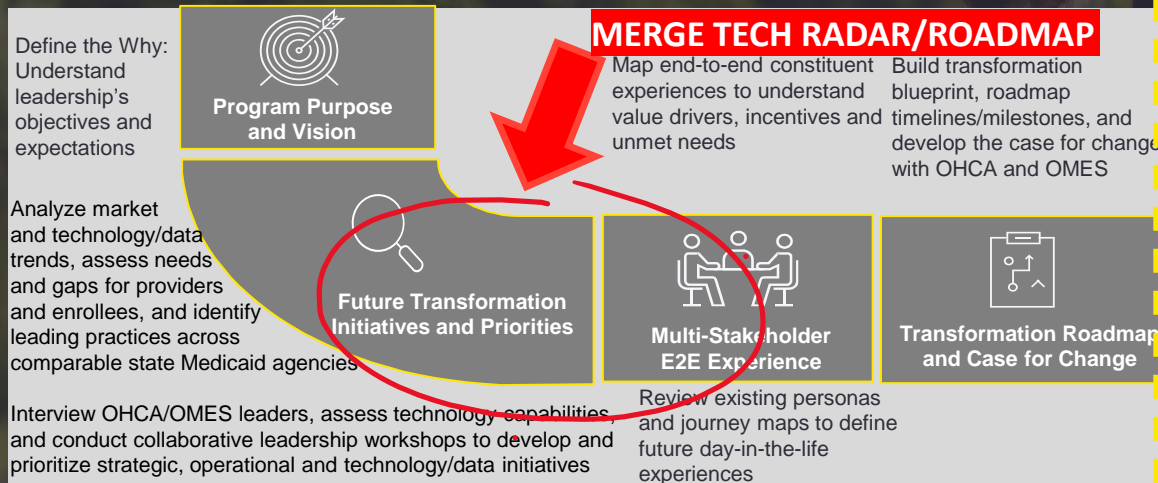

2 Design and Develop

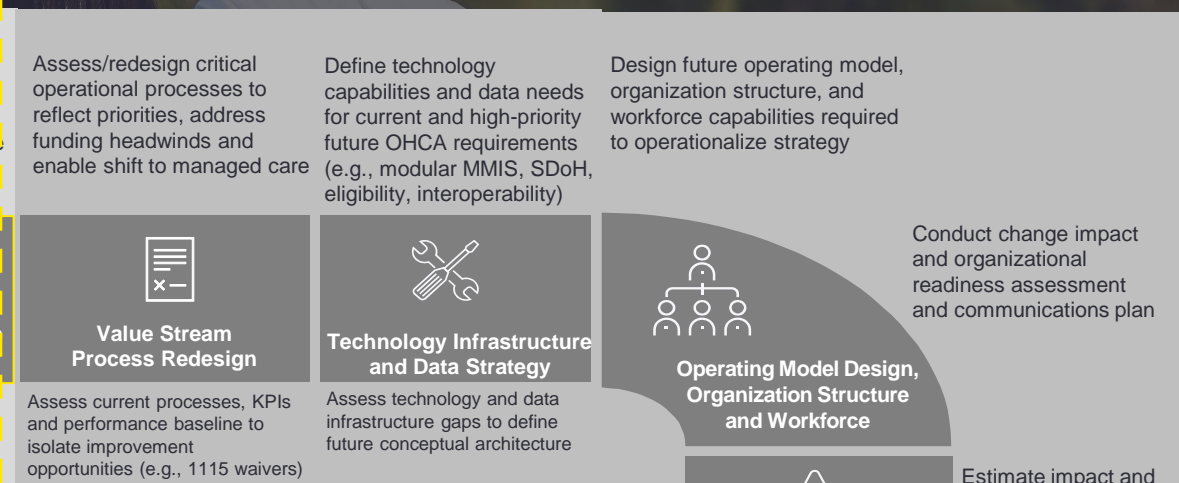

Deploy and Refine 3

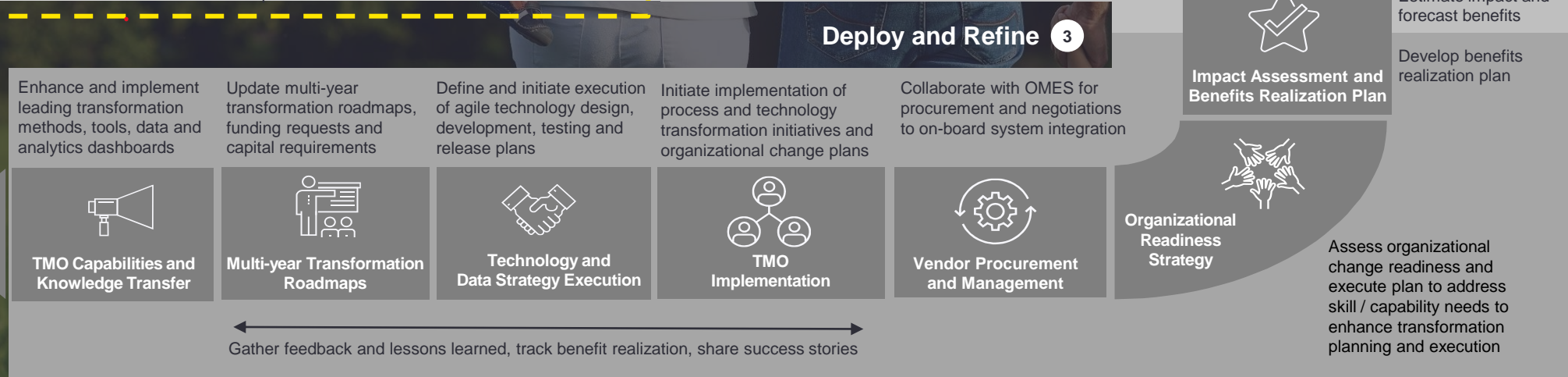

Better outcomes for Medicaid recipients and those that provide care to them

BE/IT ORGANIZATION



BE / IT Organization Makeup

- BE Primarily Supports MMIS
- Technical Personnel for Applications / Solution Integration – 2
- OMES Support Model Developing
- Survey underway (Info-Tech) on Technology Satisfaction and Performance. - Benchmark Results in Feb

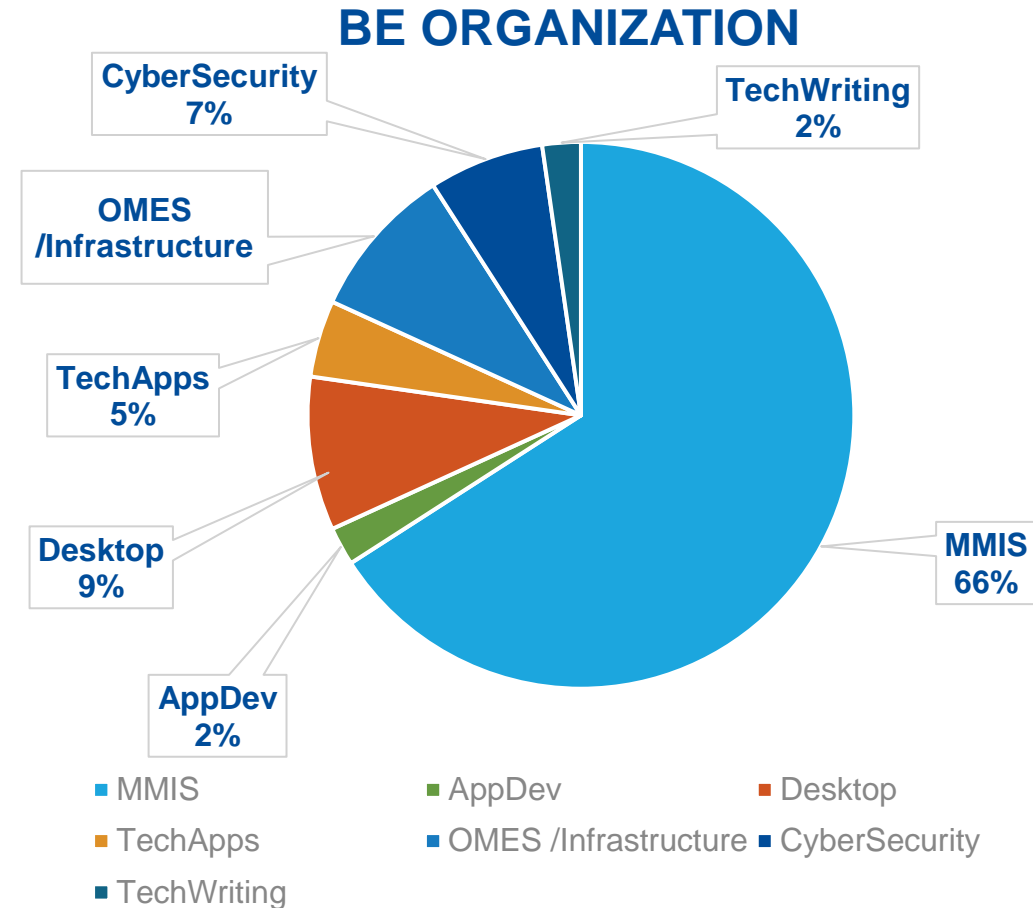

34 FTE's (Plus 7 OMES, 3 Contractors)
* Does not include shadow IT resources

KEY TAKE AWAYS / NEXT STEPS

OBSERVATIONS

- Demand on BE/IT outpaces resources – prioritization necessary
- Majority of IT staffing is in MMIS support.
- Technical Architects needed!

NEXT STEPS

- Organize roadmap into ranking format with project descriptions.
- Develop and vet prioritization process.
- Develop RIO calculator.



OKLAHOMA

OHCA 3-year IT Strategic Plan

CTO Stephen Miller

"Governor Stitt's four pillars drive the role of technology in state government, the state IT enterprise, and management of IT investment."— Jerry Moore, Deputy Director, OMES.

Driving hope
for all
Oklahomans

Protecting
Oklahomans

Becoming a
top 10 state
for business

Delivering
taxpayers
more for
their money

HIE UPDATE



HIE UPDATE

► Okshine.ok.gov

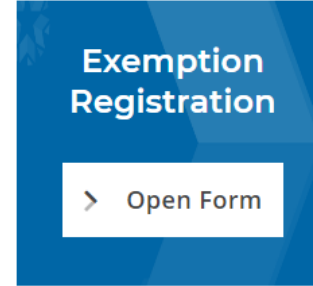
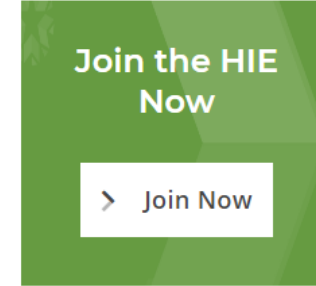
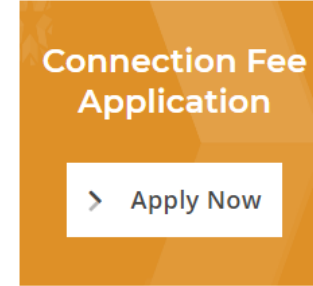

- Progress Statistics

- Averaging >35,000 Unique Patient's records accessed monthly
 - **75% increase in Utilization from Sept 2022**
- Over 500 organizations participate in the HIE serving patients in 1500 Locations
 - **130 Organizations joined in last Year, that's a 35% increase in membership**
- Dental MCE's Contracted with HIE: Training / Connection In Process. Medical MCE's finalizing contracts.
- Exemptions: **Granted: 2621**, Requested: 4759 (980 not required, 1078 not identifiable, 84 in review)

- Directed Payments – Webinar January 24th

- Select Medicaid provider types who participate in the HIE (send data & utilize) can receive & additional **+/- 9.5%** reimbursement (On top of DP Medicaid Participation Bonus of **+/- 18.5%**) for as much as **28% total**.
- Provider Types: Advance practice nurses, mid-level practitioners, mental health providers and licensed behavioral health practitioners¹, podiatrist, physician², or anesthesiologist assistant.

- Continuity and Connectivity Contract with MyHealth

- Contract Awarded 12/22/23
- **Roughly 100 Organizations are in the queue to be connected** and utilize connection fee assistance, more expected.
- Not expecting to utilize entire \$30M in first year and requesting carry-over (actual 2-3 Million).
- RFP Development Complete – Sending to OMES/OHCA Legal for Review by end of January, Release April, Award July

WHY AN HIE

- Enhanced care coordination
 - Improved Assessment
 - Close Gaps in Care
 - Enables Follow-Up
 - Enables faster care management
- Reduced costs of care
- Address Social needs
- Quicker access to care and services



THE HIE PROVIDES A PATH TO HEALTHIER OUTCOMES FOR OKLAHOMANS

**January 17, 2024 Board
Proposed Rule Amendment Summaries**

EMERGENCY RULES

All the proposed **EMERGENCY** rules were consulted on at Tribal Consultation and considered by the Medical Advisory Committee. These changes were subject to at least a 14-day public review period.

The Governor will have until Mar. 1, 2024, to approve or disapprove each rule, upon the Agency's submission for gubernatorial review.

The following **EMERGENCY** rules *were* previously adopted by the Board on Sept. 20, 2023, under **EMERGENCY** rule making.

The Agency submitted the emergency rules for gubernatorial review on Sept. 20 – Sept. 21 and no action was taken by 45th day of review. The Agency is requesting the Board to re-adopt the following proposed emergency rules so they may be resubmitted for the Governor's review and approval.

- i. **APA WF # 24-07 Secure Mental Health Transportation** (*previously APA WF # 23-13*) — The proposed additions implement secure mental health transportation as a covered benefit for SoonerCare members. Policy will define the service as secure transportation to a facility arranged by a Qualified Transportation Service Provider (QTSP) for the appropriate, medically necessary services to treat members experiencing a behavioral health crisis. Rules will include the specific contracted with the Oklahoma Department of Mental Health & Substance Abuse Services (ODMHSAS) requirements including for eligible providers (driver/contractor), member program eligibility, covered services, and the distance that will be taken into consideration when transporting members. Finally, additions will state that reimbursement for secure mental health transportation is outlined in the Oklahoma Medicaid State Plan.

Budget Impact: The estimated budget impact, for SFY2024, will be an increase in the total amount of \$6,153,652; with \$1,939,170 in state share. The estimated budget impact, for SFY2025 will be an increase in the total amount of \$6,153,652; with \$1,939,170 in state share.

- ii. **APA WF # 24-08 Biosimilar Reimbursement** (*previously APA WF # 23-15*) — These emergency revisions are necessary to avoid violation of federal law at 42 USC 1395w (Section 11403 of the Inflation Reduction Act of 2022). The proposed additions align reimbursement for certain biosimilar products with the Medicare Part B fee schedule. The Inflation Reduction Act (2022) included a provision directing Medicare Part B to increase reimbursement for certain biosimilar products from Average Sales Price (ASP) + 6% to ASP + 8%. Based on CMS guidance, policy will be amended to replace specific references to ASP + 6% with language indicating payment will match the Medicare Part B fee schedule.

Budget Impact: The estimated budget impact, for SFY2023, will be an increase in the total amount of \$200,320; with \$45,353 in state share. The estimated budget impact, for SFY2024 will be an increase in the total amount of \$600,691; with \$189,378 in state share.

- iii. **APA WF # 24-09 Continuous Eligibility for Children** (*previously APA WF # 23-18*) – These emergency revisions are necessary to protect the public health, safety, and/or welfare and to avoid violation of federal law at Public Law 117-328. The proposed revisions update eligibility policy for SoonerCare to implement 12-months continuous eligibility for children under age 19 receiving services through Medicaid and the Children's Health Insurance Plan (CHIP), effective January 1, 2024, in compliance with the Consolidated Appropriations Act of 2023.

Budget Impact: The estimated total cost for SFY 2024 is \$2,975,508 (\$2,009,360 in federal share and \$966,147 in state share). The estimated total cost for SFY 2025 is \$54,941,044 (\$36,916,261 in federal share and \$18,024,783 in state share).

- iv. **APA WF # 24-10 Non-Payment of Provider Preventable Conditions** (*previously APA WF # 23-08*) — The proposed revisions to Agency rules are needed to align with the approved State Plan Amendment that complies with Centers for Medicare and Medicaid Services (CMS) final rule regarding Section 2702 of the Affordable Care Act, which reduces or prohibits payments related to provider preventable conditions (PPCs). PPCs include Health Care Acquired Conditions (HCACs) which apply to any inpatient hospital settings and Other-Provider Preventable Conditions (OPPCs) which apply to any health care setting. The Agency's list of PPCs for non-payment will align with the PPCs as identified by Medicare with exceptions for pediatric and obstetric patients for Deep Vein Thrombosis (DVT)/Pulmonary Embolism (PE) following total knee replacement or hip replacement surgery. In aligning with Medicare, two additional OPPCs for Surgical Site infection following cardiac implantable electronic device (CIED) and iatrogenic pneumothorax with venous catheterization.

Budget Impact: Budget neutral.

The following **EMERGENCY** rules *were not* previously adopted under **EMERGENCY** rule making and are new to the Board.

- v. **APA WF # 24-01 Opioid Overdose Reversal Agents** – These emergency revisions are necessary to protect the public health, safety, and/or welfare. The proposed policy additions are to provide coverage for new opioid overdose reversal agents as they come to market. Current language allows coverage of Naloxone by name but no other such agents, as Naloxone was the first available and no others had been available until recently. With new opioid overdose reversal agents coming available, broader language will allow coverage of those products when appropriate.

Budget Impact: Budget neutral.

- vi. **APA WF # 24-02 Federally Qualified Health Center (FQHC) Substance Use Disorder (SUD) Certification Requirements** — The proposed revisions amend rules to comply with state statute at Title 43 Oklahoma Statute § 3-415. House Bill 1071 of the 2021 legislative session added Health Centers (FQHCs) to the list of providers that do not require certification by the Oklahoma Department of Mental Health and Substance Abuse Services (ODHMSAS) to provide SUD services. The intent of this legislation was to remove barriers for ambulatory SUD services in the primary care setting. Proposed revisions will update and clarify the certification requirements for Health Centers.

Budget Impact: Budget neutral.

vii. APA WF # 24-06 Living Choice — These emergency revisions are necessary to protect the public health, safety, and/or welfare and to comply with Section 2403 of the Affordable Care Act, as amended by the Consolidated Appropriations Act of 2021. The proposed revisions clarify that time a member spends within a skilled nursing facility will be considered when assessing timeline requirements for applications to the Living Choice program. Current policy requires a member to live in a qualifying facility for at least 60 days before applying for Living Choice, but excludes time spent in a skilled nursing facility (SNF) from this 60-day period. This change also aligns OHCA policy with current federal requirements.

Budget Impact: Budget neutral.

PERMANENT RULES

All the proposed **PERMANENT** rules were consulted on at Tribal Consultation and considered by Medical Advisory Committee. These changes were subject to a 30-day public review period from **Dec. 1 through Jan. 2, 2024**.

The Agency is requesting the effective date to be **Sept. 2023**, contingent upon receiving legislature and gubernatorial approval.

The following **PERMANENT** rules were previously adopted by the Board and the Governor under **EMERGENCY** rulemaking. These rules were revised for **PERMANENT** rulemaking.

viii. APA WF # 23-06A&B Transition to SoonerSelect — The proposed policy provision implement managed care rules for contracted entities, dental benefit managers, and provider-led entities. Proposed revisions will remove definitions that are not used elsewhere in the chapter, adds additional language regarding cost-sharing protections for members, and removes a section that could obligate members to payment recoupment for services provided during an appeal if an adverse benefit determination was made.

Budget Impact: Budget neutral.

ix. APA WF # 23-20 TEFRA Psychological Evaluations and ICF/IID Level of Care Reevaluations — The proposed rule changes help alleviate wait times for TEFRA approval by adding additional provider types to conduct psychological evaluations for TEFRA applicants. In addition to licensed psychologists or school psychologists as currently outlined in policy, certified psychometrists, psychological technicians under the supervision of a psychologist, and licensed behavioral health professionals will be added to policy. Additionally, policy will be revised to reflect a new business process of conducting ICF/IID level of care reevaluations biennially rather than annually. Finally, and in addition to the emergency rule changes, revisions will allow providers to determine the appropriate intelligence testing alternative for small children.

Budget Impact: Budget neutral.

x. APA WF # 23-09 Update Services Exempt from Copayment — The proposed policy changes are currently in effect ad Emergency Rules and must be promulgated as Permanent Rules. The Affordable Care Act (ACA) requires states to cover preventive services for expansion adults without any cost sharing. The proposed rules will update the list of services exempted from copayments to ensure the ACA requirement is reflected in

the rule. Additionally, the proposed rule changes will exempt vaccine administration and changes made through the permanent rule process will also exempt opioid overdose reversal agents from cost-sharing requirements.

Budget Impact: The estimated budget impact, for SFY2023, will be an increase in the total amount of \$81,123; with \$8,122 in state share. The estimated budget impact, for SFY2024 will be an increase in the total amount of \$81,123; with \$8,112 in state share.

The following **PERMANENT** rules *were* previously adopted by the Board and the Governor under **EMERGENCY** rulemaking. These rules *were not* revised for **PERMANENT** rule making.

- xi. APA WF # 23-01 State Plan Personal Care Services for Expansion Adults, TEFRA Eligible Children and Certain MAGI Populations** — Proposed revisions add new policy to delineate eligibility requirements, definitions, medical eligibility criteria for personal care, and the process for medical eligibility determinations. Additionally, rules are added to reflect the current business practice for approving the TEFRA population and any EPSDT members who meet medical necessity to receive personal care services.

Budget Impact: The estimated budget impact, for SFY2023, is an increase in the total amount of \$91,173; with \$25,200 in state share. The estimated budget impact, for SFY2024 is an increase in the total amount of \$273,520; with \$88,921 in state share.

- xii. APA WF # 23-02 IO ESI Self-funded Plans** — The proposed rules will update Insure Oklahoma policy to comply with Oklahoma Senate Bill 1323, which added language to Title 56 Oklahoma Statutes (O.S.) § 1010.1. The policy additions mirror the bill's language regarding self-funded/self-insured plans to address that qualified benefit plans may become a self-funded or self-insured benefit plan if certain criteria are met.

Budget Impact: Budget neutral.

- xiii. APA WF # 23-05 SoonerCare Application Timeframe** — The proposed policy changes are currently in effect as Emergency Rules and must be promulgated as Permanent Rules. These revisions update rules on application procedures regarding the process of filing a Notification of Date of Service (NODOS). The current five (5) day requirement for the hospital to file the electronic NODOS will remain in effect; however, after the electronic NODOS is filed, the applicant or someone acting on behalf of the applicant will have forty (40) days to submit a completed SoonerCare application instead of the current fifteen (15) days.

Budget Impact: The estimated total cost for SFY 2024 is \$420,861 (\$284,039 in federal share and \$136,822 in state share). The estimated total cost for SFY 2025 is \$561,147 (\$378,718 in federal share and \$182,429 in state share).

- xiv. APA WF 23-10 Doula Services** — The proposed revisions add doula services as a covered benefit to SoonerCare members. The policy additions outline what a doula is and the specific services/requirements including but not limited to, certification requirements from one of the Agency-recognized organizations, a referral from a licensed medical provider (physician, physician's assistant (PA), obstetrician, certified nurse midwife), and

be at least 18 years of age. Furthermore, policy outlines that members will have eight doula visits, including one for labor and delivery care. Finally, additions state that reimbursement for doula services is outlined in the Oklahoma Medicaid State Plan.

Budget Impact: The estimated budget impact for SFY 2024 will be an increase in the total amount of \$2,734,572; with \$861,732 in state share. The estimated budget impact for SFY 2025 will be an increase in the total amount of \$2,734,572; with \$887,916 in state share.

- xv. **APA WF # 23-11 Private Duty Nursing Reimbursement** — The proposed policy changes are currently in effect ad Emergency Rules and must be promulgated as Permanent Rules. These revisions will add clarification regarding the reimbursement for Private Duty Nursing (PDN) services, including when overtime payment is appropriate. Further revisions will state that overtime is only available for nursing staff who are providing services to members with tracheostomies or who are medically dependent on a ventilator for life support at least six (6) hours per day. This excludes members who are on non-invasive C-PAP or Bi-PAP devices only.

Budget Impact: The estimated budget impact for SFY 2023 will be an increase in the total amount of \$2,414,603; with \$782,392 in state share. The estimated budget impact for SFY 2024 will be an increase in the total amount of \$7,243,810; with \$2,347,175 in state share.

- xvi. **APA WF # 23-12 Intermediate Care Facilities Payment Program** — The proposed policy changes are currently in effect ad Emergency Rules and must be promulgated as Permanent Rules. These revisions implement changes to comply with Oklahoma Senate Bill 1074 which authorizes the Oklahoma Health Care Authority (OHCA) to implement an enhanced payment program for Intermediate Care Facilities for Individuals with Intellectual Disabilities (ICFs/IID) that offer vocational services or day program services or both. The purpose of the enhanced payment is to offset the costs incurred by ICFs/IID in these services as these services are currently funded by donations/charity. The enhanced payment will be in addition to all other reimbursement from the OHCA.

Budget Impact: The estimated total cost for SFY 2023 is \$2,414,603 (\$1,632,211 in federal share and \$782,392 in state share). The estimated total cost for SFY 2024 is \$7,243,810 (\$4,896,634 in federal share and \$2,347,175 in state share).

- xvii. **APA WF # 23-14 Audio-only Telecommunications Health Service Delivery** — The proposed policy changes are currently in effect ad Emergency Rules and must be promulgated as Permanent Rules. These revisions allow for the audio-only telecommunications health service delivery for medically necessary covered primary care and other approved health services. Audio-only telecommunications delivery means healthcare services delivered through the use of audio-only technology, permitting real-time communication between a patient and the provider, for the purpose of diagnosis, consultation, or treatment, and does not include the use of facsimile or email nor the delivery of health care services that are customarily delivered by audio-only technology and customarily not billed as separate services by the provider, such as the sharing of laboratory results. The proposed rules include definitions and requirements for service provision and reimbursement.

Budget Impact: The estimated total cost for SFY 2024 is \$1,759,405 (\$1,204,972 in federal share and \$554,433 in state share). The estimated total cost for SFY 2025 is \$1,759,405 (\$1,188,126 in federal share and \$571,279 in state share).

- xviii. **APA WF 23-16A&B Minimum Age for Enrollment into ADvantage Waiver** — The Oklahoma Health Care Authority (OHCA) seeks to align rules with the 1915(c) HCBS ADvantage Waiver which was recently amended to lower the eligibility age that an individual can enter the program from 21 to 19 years of age to better facilitate their transition into the ADvantage Program.

Budget Impact: Budget neutral.

- xix. **APA WF # 23-17 Implement Changes to the Health Information Exchange** — The proposed policy changes are currently in effect as Emergency Rules and must be promulgated as Permanent Rules. Oklahoma Senate Bill 1369 made changes to the Statewide HIE during the 2022 legislative session. The Agency promulgated permanent rules which were adopted by the OHCA Board on March 22, 2023; however, the proposed rules were disapproved by the Governor on June 23, 2023. The new proposed revisions were written in order to align policy with feedback received from members, providers, and the Governor to allow the HIE Coordinator to grant exemptions from the HIE when requested by any provider. Additionally, the proposed revisions provide information about the availability of grant funds to help cover connection fees.

Budget Impact: The proposed rules are budget neutral for the agency; however, there will be a cost for providers to connect and subscribe to the statewide HIE as well as grant funds to help cover the connection costs.

- xx. **APA WF # 23-19 Adult Day Health Services Revisions** — These emergency revisions are necessary to maintain the level of support for individuals who are eligible to receive HCBS 1915(c) waiver services by providing the same amount of adult day health they were receiving while on the DDS Aging state-funded services wait list. The maximum number of adult day health units that can be provided in a day will increase from six (6) to eight (8) hours. Additionally, policy revisions will change the name from adult day services to adult day health.

Budget Impact: The estimated budget impact for SFYs 2024 and 2025 is a savings in state funds of \$1,020,564 for SFY 2024 and a savings in state funds of \$2,041,128 for SFY 2025. Adult Day Health is paid 100% from state funds when eligible individuals need eight hours of services per day but receive fewer than eight. Increasing the cap to eight hours per day allows use of federal dollars.

- xxi. **APA WF # 23-21 Quarterly Payments for Orthodontic Services** — The Agency proposes to transition the current orthodontic payment protocol from a bulk payment system to a quarterly payment protocol. The new payment protocol will be based on twenty-four (24) months with built in progress reports. Proposed revisions will remove outdated language and add new language to delineate the new payment criteria and billing instructions.

Budget Impact: The proposed rule changes are budget neutral due to no change in the reimbursement amount.

The following **PERMANENT** rules *were not* previously adopted and are new to the Board.

- xxii. APA WF # 23-24 Prosthetic Hearing Implants & Ocular Prosthetics for Adults** — The agency proposes rule revisions to clarify coverage of prosthetic hearing implants and ocular prosthetics for adults in the expansion population. These services and devices are authorized within the Medicaid State Plan; these revisions will clarify coverage for these devices and the surrounding services.

Budget Impact: Budget neutral.

- xxiii. APA WF 23-23 Hospital Services Policy** — The proposed revisions seek to revise the Oklahoma Health Care Authority's Hospital policy to reflect current business practices. Revisions will remove outdated language, definitions, and requirements. Other revisions will provide clarification to existing criteria surrounding items including non-covered outlier payments by providers, how a member is considered inpatient versus outpatient, payment structures, etc. Final revisions will make other grammatical and formatting changes as needed.

Budget Impact: Budget neutral.

- xxiv. APA WF # 23-22 Streamline Behavioral Health Workforce Credentialing** — The proposed policy changes are Permanent Rules. The proposed rule changes include the incorporation of Family Support Providers (FSPs) as certified Peer Recovery Support Specialists (PRSS), similar to other states. Moreover, these changes create multiple career pathways through work experience and/or college credit to increase availability of case managers. Changes will reduce the experience required for CM I and add alternative qualifications for CM II other than a college degree.

Budget Impact: Budget neutral.

- xxv. APA WF # 23-25A&B Advantage and State Plan Personal Care Revisions** — The proposed rule revisions for the 1915(c) Home and Community Based Services (HCBS) ADvantage Waiver program and State Plan Personal Care Services seek to remove outdated processes, reduce unnecessary timeline and procedural burdens, clarify modalities used in medical eligibility assessments, and match recent system changes. Proposed revocations remove individual personal care assistants (IPCA) which are no longer used in these programs. Resumption of services information is removed from the closure section to reduce duplication. Proposed revisions also add Living Choice as a referral option when appropriate and provide general cleanup to the language.

Budget impact: Budget neutral.

- xxvi. APA WF # 23-26 340b Non-compliant Providers** — The proposed revisions ensure OHCA has mechanisms in place to preserve the net cost on prescription drug services through the current 340B Shared Savings model. The revisions institute a 45-day due date

from receipt of invoice, a monetary penalty/interest for paying after the due date (modeled on the methodology used in Prompt Payment Rules promulgated by OMES, OAC 260:10-3-3), and the ability to withhold payment from facilities that are non-compliant in order to receive the unpaid invoice amounts.

Budget Impact: Budget neutral.

- xxvii. APA WF # 23-27A&B DDS Updates** — The proposed revisions seek to update Developmental Disabilities Services (DDS) rules to align with the amendments to the DDS 1915(c) Home and Community Based Services (HCBS) waiver programs that were approved by the Centers for Medicare and Medicaid Services (CMS), effective July 1, 2023. The proposed revisions increase the annual cap for Community Transition Services from \$2,400 to \$3,000, update outdated terms relating to agency and division names, and remove obsolete references to architectural modifications.

Budget impact: Expected cost of increasing the cap for Community Transition Services is \$64,800 for SFY 2025, of which \$21,040.56 is state funds.

**TITLE 317. OKLAHOMA HEALTH CARE AUTHORITY
CHAPTER 30. MEDICAL PROVIDERS-FEE FOR SERVICE**

SUBCHAPTER 5. INDIVIDUAL PROVIDERS AND SPECIALTIES

PART 34. SECURE BEHAVIORAL HEALTH TRANSPORTATION

317:30-5-347. Definitions

The following words and terms, when used in this Part shall have the following meaning, unless context clearly indicates otherwise:

"Member/eligible member" means any person eligible for SoonerCare and individuals considered to be Medicare/SoonerCare dual eligible.

"Nearest appropriate facility" means a medical facility that is generally equipped and legally permitted to provide the needed care for the illness or injury involved that is the closest in geographical proximity to the member's pickup location.

"OAC" means Oklahoma Administrative Code.

"ODMHSAS" means the Oklahoma Department of Mental Health and Substance Abuse Services.

"O.S." means Oklahoma Statutes.

"Qualified Transportation Service Provider" or "QTSP" means an ODMHSAS-contracted transportation provider for members requiring transportation to a treatment facility for the purpose of examination, emergency detention, protective custody, or inpatient services in accordance with 43A O.S. § 1-110.

317:30-5-348. Program overview

(a) ODMHSAS-contracted Qualified Transportation Service Providers (QTSPs) are required to transport SoonerCare members reasonably believed to be experiencing a behavioral health crisis to and from designated sites/facilities for the purpose of examination, emergency detention, protective custody, or inpatient services in accordance with 43A O.S. § 1-110.

(b) SoonerCare members being transported shall be afforded all rights and privileges guaranteed by the laws and Constitution of the State of Oklahoma and the United States of America. SoonerCare members have the right to be transported in a way that protects their dignity and safety.

(c) Mechanical restraints may only be used in the transportation of members when needed in accordance with 43A O.S. § 1-110 and as defined in the QTSP's contract with ODMHSAS.

317:30-5-349. Program eligibility and covered services

(a) SoonerCare members, both children and adults, are eligible for services when medically necessary.

(b) A member must be reasonably believed to be experiencing a behavioral health crisis as evidenced by extreme emotional distress that includes, but is not limited to, an acute episode of mental illness and/or suicidal thoughts and/or behavior that may occur with substance use and other disorders.

(c) Secure behavioral health transportation may be provided when medically necessary for the following:

(1) Transportation to a facility arranged by individuals authorized by ODMHSAS, including but not limited to, hospitals and other mental health facilities;

(2) Facility-to-facility transports; and

(3) Transport of a member seeking voluntary admission to a facility.

(d) Members must be transported to the nearest appropriate facility.

(e) Out-of-state transports are allowable when medically necessary and may require prior approval or authorization by ODMHSAS.

317:30-5-350. Service requirements

(a) **Eligible providers.** Service providers must be ODMHSAS-contracted Qualified Transportation Service Providers (QTSPs) and meet the Uniform Transportation Standards for QTSPs described in this Section.

(b) **Driver requirements.** Drivers must:

(1) Be twenty-one (21) years of age or older;

(2) Hold a valid driver's license issued by the State of Oklahoma;

(3) Undergo a criminal background check and not have been convicted of or received a deferred or probated sentence related to any felony crime, a crime involving moral turpitude or a crime of domestic violence; and not have any criminal charges pending in any court in the State of Oklahoma, another state, in tribal court or pursuant to the United States Code;

(4) Be able to ensure that SoonerCare members who are transported are protected by harm and injuries due to abuse, self-abuse, neglect, sexual incidents, serious injuries and other sources of immediate danger;

(5) Be able to provide emergency care or have an established plan to access emergency care;

(6) Be trained in effective communication skills with persons with mental illness, consumer rights, CPR/First Aid, and confidentiality as prescribed by ODMHSAS prior to completing transports;

(7) Be able to recognize and plan for problematic behaviors in a therapeutic and safe manner and complete a 16-hour Therapeutic Options Course or similar curriculum approved by ODMHSAS prior to completing transports; and

(8) Be familiar with the statutes and standards related to transporting members.

(c) **Vehicle requirements.** Vehicles must:

(1) Be well maintained and in good mechanical condition;

(2) Have the following equipment operational:

(A) Air conditioner;

(B) Heater; and

(C) Chemical-type fire extinguisher, of at least a one-quart capacity, located in the same compartment of the vehicle as the driver.

(3) Have a safety partition between the driver's area and passenger's area;

(4) Have safety locks to prevent a member from exiting a car that is in motion;

(5) Be equipped with, either in the car or on the driver, a two-way radio or cellular telephone that is operational during the entire period of transport; and

(6) If transporting members in wheelchairs, be equipped with the following:

(A) An electrical or hydraulically operated lift mechanism or a ramp with a non-skid surface;

(B) A means of securing a wheelchair to the inside of the vehicle to prevent any lateral, forward, backward, or vertical motion of the wheelchair within the vehicle;

(C) A rear-view mirror that enables the driver to view any passenger in a wheelchair; and

(D) A door at the rear of the vehicle for an emergency exit.

317:30-5-351. Authorization and reimbursement

(a) Secure behavioral health transportation does not require a prior authorization, with the exception of out-of-state transports, which may require prior approval or authorization by ODMHSAS.

(b) Secure behavioral health transportation is reimbursed per the methodology described in the Oklahoma Medicaid State Plan.

DRAFT

This page intentionally left blank

**TITLE 317. OKLAHOMA HEALTH CARE AUTHORITY
CHAPTER 30. MEDICAL PROVIDERS-FEE FOR SERVICE**

SUBCHAPTER 5. INDIVIDUAL PROVIDERS AND SPECIALTIES

PART 5. PHARMACIES

317:30-5-78. Reimbursement

(a) **Reimbursement.** Reimbursement for pharmacy claims is based on the sum of the ingredient cost plus a professional dispensing fee for brand and generic drugs dispensed by a retail community pharmacy or for a member residing in a long term care facility.

(b) **Ingredient Cost.** Ingredient cost is determined by one of the following methods:

(1) **Maximum Allowable Cost.** The State Maximum Allowable Cost (SMAC) is established for certain products which have a Food and Drug Administration (FDA) approved generic equivalent. The SMAC will be calculated using prices from pharmaceutical wholesalers who supply these products to pharmacy providers in Oklahoma. Pharmacies may challenge a specific product's SMAC price by providing information from their wholesaler(s) to certify a net cost higher than the calculated SMAC price and that there is not another product available to them which is generically equivalent to the higher priced product.

(2) **Actual Acquisition Cost.** The Actual Acquisition Cost (AAC) means the cost of a particular drug product to the pharmacy based on a review of invoices or the Wholesale Acquisition Cost (WAC), whichever is lower. The National Average Drug Acquisition Cost (NADAC) is based on a review of invoices and published by Centers for Medicare and Medicaid Services (CMS) and will be used in the determination of AAC.

(3) **Specialty Pharmaceutical Allowable Cost.** Reimbursement for specialty drugs not typically dispensed by a retail community pharmacy and dispensed primarily by delivery, including clotting factor for hemophilia, shall be set as a Specialty Pharmaceutical Allowable Cost (SPAC). The Medicare Part B allowed charge, ~~defined as Average Sales Price (ASP) plus 6%~~, WAC, and NADAC when available, will be considered in setting the SPAC rate. For the purpose of this section, a drug may be classified as a specialty drug when it has one or more of the following characteristics:

- (A) Covered by Medicare Part B;
- (B) "5i drug" B Injected, infused, instilled, inhaled, or implanted;
- (C) Cost greater than \$1,000.00 per claim;
- (D) Licensed by the FDA under a Biological License Application;
- (E) Special storage, shipping, or handling requirements;
- (F) Available only through a limited distribution network; and/or
- (G) Does not have a NADAC price from CMS.

(4) **Exceptions.**

(A) Physician administered drugs shall be priced based on a formula equivalent to the Medicare Part B allowed charge, ~~defined as ASP plus 6%~~. If a price equivalent to the Medicare Part B allowed charge cannot be determined, a purchase invoice may be supplied by the provider and will be considered in setting the reimbursement.

(B) I/T/U pharmacies shall be reimbursed at the OMB encounter rate as a per member per facility per day fee regardless of the number of prescriptions filled on that day. I/T/U pharmacies should not split prescriptions into quantities less than a one month

supply for maintenance medications. For this purpose a maintenance medication is one that the member uses consistently month to month.

(C) Pharmacies other than I/T/U facilities that acquire drugs via the Federal Supply Schedule (FSS) or at nominal price outside the 340B program or FSS shall notify OHCA and submit claims at their actual invoice price plus a professional dispensing fee.

(c) **Professional dispensing fee.** The professional dispensing fee for prescribed medication is established by review of surveys. A recommendation is made by the State Plan Amendment Rate Committee and presented to the Oklahoma Health Care Authority Board for their approval. There may be more than one level or type of dispensing fee if approved by the OHCA Board and CMS. A contracted pharmacy agrees to participate in any survey conducted by the OHCA with regard to dispensing fees. The pharmacy shall furnish all necessary information to determine the cost of dispensing drug products. Failure to participate may result in administrative sanctions by the OHCA which may include but are not limited to a reduction in the dispensing fee.

(d) **Reimbursement for prescription claims.** Prescription claims will be reimbursed using the lower of the following calculation methods:

- (1) the lower of Actual Acquisition Cost (AAC), State Maximum Allowable Cost (SMAC), or Specialty Pharmaceutical Allowable Cost (SPAC) plus a professional dispensing fee, or
- (2) usual and customary charge to the general public. The pharmacy is responsible to determine its usual and customary charge to the general public and submit it to OHCA on each pharmacy claim. The OHCA may conduct periodic reviews within its audit guidelines to verify the pharmacy's usual and customary charge to the general public and the pharmacy agrees to make available to the OHCA's reviewers prescription and pricing records deemed necessary by the reviewers. The OHCA defines general public as the patient group accounting for the largest number of non-SoonerCare prescriptions from the individual pharmacy, but does not include patients who purchase or receive their prescriptions through other third-party payers. If a pharmacy offers discount prices to a portion of its customers (i.e. -10% discount to senior citizens), these lower prices would be excluded from the usual and customary calculations unless the patients receiving the favorable prices represent more than 50% of the pharmacy's prescription volume. The usual and customary charge will be a single price which includes both the product price and the dispensing fee. For routine usual and customary reviews, the pharmacy may provide prescription records for non-SoonerCare customers in a manner which does not identify the customer by name so long as the customer's identity may be determined later if a subsequent audit is initiated. The OHCA will provide the pharmacy notice of its intent to conduct a review of usual and customary charges at least ten days in advance of its planned date of review.

(e) **Payment of Claims.** In order for an eligible provider to be paid for filling a prescription drug, the pharmacy must complete all of the following:

- (1) have an existing provider agreement with OHCA,
- (2) submit the claim in a format acceptable to OHCA,
- (3) have a prior authorization before filling the prescription, if a prior authorization is necessary,
- (4) have a proper brand name certification for the drug, if necessary, and
- (5) include the usual and customary charges to the general public as well as the actual acquisition cost and professional dispensing fee.

(f) **Claims.** Prescription reimbursement may be made only for individuals who are eligible for coverage at the time a prescription is filled. Member eligibility information may be accessed by swiping a SoonerCare identification card through a commercial card swipe machine which is connected to the eligibility database or via the Point of Sale (POS) system when a prescription claim is submitted for payment. Persons who do not contract with commercial vendors can use the Member Eligibility Verification System (EVS) at no additional cost.

PART 5. MEDICAL SUPPLIERS

317:30-5-218. Reimbursement

(a) **Medical supplies, equipment and appliances.**

(1) Reimbursement for medical supplies, equipment, and appliances will be made using an amount derived from the lesser of the Oklahoma Health Care Authority (OHCA) maximum allowable fee or the provider's usual and customary charge. The maximum allowable fee is the maximum amount that the OHCA will pay a provider for an allowable procedure. When a code is not assigned a maximum allowable fee for a unit of service, a fee will be established.

(2) The fee schedule will be reviewed annually. Adjustments to the fee schedule may be possible at any time based on efficiency, budget considerations, federal regulations, and quality of care as determined by the OHCA.

(3) Payment for medical supplies, equipment, and appliances will be calculated using the rate methodologies found in the Oklahoma Medicaid State Plan.

(4) Payment is not made for medical supplies, equipment, and appliances that are not deemed as medically necessary or considered over-the-counter.

(5) OHCA does not reimburse medical supplies, equipment, and appliances providers separately for services that are included as part of the payment for another treatment program. For example, all items required during inpatient stays are paid through the inpatient payment structure.

(6) Medical supplies, equipment, and appliance products purchased at a pharmacy are paid the equivalent to the Medicare Part B allowed charge, ~~average sales price (ASP) + six percent (6%)~~. When ASP the Medicare Part B allowed charge is not available, an equivalent price is calculated using ASP or wholesale acquisition cost (WAC). If no Medicare, ASP, or WAC pricing is available, then the price will be calculated based on invoice cost.

(b) **Manually-priced medical equipment and supplies.** There may be instances when manual pricing is required. When it is, the following pricing methods will be used:

(1) **Invoice pricing.** Reimbursement is at the provider's documented manufacturer's suggested retail price (MSRP) minus thirty percent (30%) or at the provider's invoice cost plus thirty percent (30%), whichever is the lesser of the two.

(2) **Fair market pricing.** OHCA may establish a fair market price through claims review and analysis. For a list of medical equipment and supplies that are fair market-priced, refer to the OHCA website at www.okhca.org for the fair market value list (Selected medical supplies, equipment, and appliance items priced at fair market price).

(c) **Oxygen equipment and supplies.**

(1) Payment for stationary oxygen systems (liquid oxygen systems, gaseous oxygen systems, and oxygen concentrators) is based on continuous rental, i.e., a continuous monthly payment

that is made as long as it is medically necessary. The rental payment includes all contents and supplies, e.g., regulators, tubing, masks, etc. Portable oxygen systems are considered continuous rental. Ownership of the equipment remains with the supplier.

(2) Separate payment will not be made for maintenance, servicing, delivery, or for the supplier to pick up the equipment when it is no longer medically necessary. In addition, the provider/supplier will not be reimbursed for mileage.

(3) Payment for oxygen and oxygen equipment and supplies will not exceed the Medicare fee for the same procedure code.

(4) For residents in a long-term care facility, durable medical equipment products, including oxygen, are included in the facility's per diem rate.

DRAFT

**TITLE 317. OKLAHOMA HEALTH CARE AUTHORITY
CHAPTER 35. MEDICAL ASSISTANCE FOR ADULTS AND CHILDREN-
ELIGIBILITY**

SUBCHAPTER 1. GENERAL PROVISIONS

317:35-1-2. Definitions

The following words and terms, when used in this Chapter, have the following meaning, unless the context clearly indicates otherwise:

"Acute Care Hospital" means an institution that meets the requirements defined in Section (§) 440.10 of Title 42 of the Code of Federal Regulations (C.F.R.) and:

(A) Is maintained primarily for the care and treatment of patients with disorders other than mental diseases;

(B) Is formally licensed or formally approved as a hospital by an officially designated authority for state standard setting; and

(C) Meets the requirements for participation in Medicare as a hospital.

"Adult" means an individual twenty-one (21) years of age or older, unless otherwise specified by statute, regulation, and/or policy adopted by the Oklahoma Health Care Authority (OHCA). For eligibility criteria policy for children and adults, please refer to Oklahoma Administrative Code (OAC) 317:35-5-2.

"ADvantage Administration (AA)" means the Oklahoma Department of Human Services (OKDHS) which performs certain administrative functions related to the ADvantage Waiver.

"Aged" means an individual whose age is established as sixty-five (65) years or older.

"Agency partner" means an agency or organization contracted with the OHCA that will assist those applying for services.

"Aid to Families with Dependent Children (AFDC)" means the group of low-income families with children described in Section 1931 of the Social Security Act. The Personal Responsibility and Work Opportunity Act of 1996 established the new eligibility group of low-income families with children and linked eligibility income and resource standards and methodologies and the requirement for deprivation for the new group to the State plan for AFDC in effect on July 16, 1996. Oklahoma has elected to be less restrictive for all SoonerCare members related to AFDC. Children covered under Section 1931 are related to the children's group, and adults covered under Section 1931 are related to the parent and caretaker relative group. The Modified Adjusted Gross Income (MAGI) methodology is used to determine eligibility for these groups.

"Alien" is synonymous with the word "noncitizen" and means an individual who does not have United States citizenship and is not a United States national.

"Area nurse" means a registered nurse in the OKDHS Aging Services Division, designated according to geographic areas who evaluates the Uniform Comprehensive Assessment Tool (UCAT) and determines medical eligibility for Personal Care, ADvantage Waiver, and Nursing Facility services. The area nurse also approves care plan and service plan implementation for Personal Care services.

"Area nurse designee" means a registered nurse selected by the area nurse who evaluates the UCAT and determines medical eligibility for Personal Care, ADvantage Waiver, and Nursing Facility services.

"Authority" means the OHCA.

"Blind" means an individual who has central visual acuity of 20/200 or less in the better eye

with the use of a correcting lens.

"Board" means the OHCA Board.

"Buy-in" means the procedure whereby the OHCA pays the member's Medicare premium.

(A) **"Part A Buy-in"** means the procedure whereby the OHCA pays the Medicare Part A premium for individuals determined eligible as Qualified Medicare Beneficiaries Plus (QMBP) who are enrolled in Part A and are not eligible for premium free enrollment as explained under Medicare Part A. This also includes individuals determined to be eligible as Qualified Disabled and Working Individuals (QDWI).

(B) **"Part B Buy-in"** means the procedure whereby the OHCA pays the Medicare Part B premium for categorically needy individuals who are eligible for Part B Medicare. This includes individuals who receive TANF or the State Supplemental Payment to the Aged, Blind or Disabled, and those determined to be Qualified Medicare Beneficiary Plus (QMBP), Specified Low Income Medicare Beneficiaries (SLMB) or Qualifying Individual-1 (QI-1). Also included are individuals who continue to be categorically needy under the PICKLE amendment and those who retain eligibility after becoming employed.

"Caretaker relative" means a person other than the biological or adoptive parent with whom the child resides who meets the specified degree of relationship within the fifth degree of kinship.

"Case management" means the activities performed for members to assist them in accessing services, advocacy and problem solving related to service delivery.

"Categorically needy" means that income and, when applicable, resources are within the standards for the category to which the individual is related.

"Categorically related" or **"related"** means the individual meets basic eligibility requirements for an eligibility group.

"Certification period" means the period of eligibility extending from the effective date of certification to the date of termination of eligibility or the date of the next periodic redetermination of eligibility.

"Child" means an individual under twenty-one (21) years of age, unless otherwise specified by statute, regulation, and/or policy adopted by the OHCA. For eligibility criteria policy for children and adults, please refer to OAC 317:35-5-2.

"Continuous eligibility" means uninterrupted eligibility for the extent of the certification period regardless of any changes in circumstances, unless:

(A) The child turns age nineteen (19);

(B) The child dies;

(C) The child is no longer an Oklahoma resident;

(D) The child becomes incarcerated (per OAC 317:35-6-45 the eligibility is suspended for the duration of the incarceration period for individuals under the age of twenty-one (21) except for periods of time that inpatient services are provided per OAC 317:35-5-26);

(E) The adult parent or caretaker relative on the case requests that the medical benefits are closed;

(F) The state has erred in the eligibility determination;

(G) The child or the adult parent or caretaker relative on the case has committed fraud or perjury in order to become eligible; or

(H) The child becomes categorically related to either the pregnancy eligibility group or the former foster care eligibility groups, thereby receiving eligibility based on such category, which is not considered an interruption in continuous eligibility.

"County" means the Oklahoma OKDHS' office or offices located in each county within the State.

"Custody" means the custodial status, as reported by OKDHS.

"Deductible/Coinsurance" means the payment that must be made by or on behalf of an individual eligible for Medicare before Medicare payment is made. The coinsurance is that part of the allowable medical expense not met by Medicare, which must be paid by or on behalf of an individual after the deductible has been met.

(A) For Medicare Part A (Hospital Insurance), the deductible relates to benefits for inpatient services while the patient is in a hospital or nursing facility. After the deductible is met, Medicare pays the remainder of the allowable cost.

(B) For Medicare Part B (Medical Insurance), the deductible is an annual payment that must be made before Medicare payment for medical services. After the deductible is met, Medicare pays eighty percent (80%) of the allowable charge. The remaining twenty percent (20%) is the coinsurance.

"Disabled" means an individual who is unable to engage in any substantial gainful activity by reason of any medically determinable physical or mental impairment which can be expected to result in death, or which has lasted (or can be expected to last) for a continuous period of not less than twelve (12) months.

"Disabled child" means for purposes of Medicaid Recovery a child of any age who is blind, or permanently and totally disabled according to standards set by the Social Security Administration.

"Estate" means all real and personal property and other assets included in the member's estate as defined in Title 58 of the Oklahoma Statutes.

"Expansion adult" means an individual defined by 42 Code of Federal Regulations (C.F.R.) § 435.119 who is age nineteen (19) or older and under sixty-five (65), at or below 133 percent of the federal poverty level (FPL), and who are not related to the aged, blind, or disabled.

"Gatekeeping" means the performance of a comprehensive assessment by the OKDHS nurse utilizing the UCAT for the determination of medical eligibility, care plan development, and the determination of Level of Care for Personal Care, ADvantage Waiver and Nursing Facility services.

"Ineligible Spouse" means an individual who is not eligible for Supplemental Security Income (SSI) but is the husband or wife of someone who is receiving SSI.

"Lawfully present" means a noncitizen in the United States who is considered to be in lawful immigration status or class.

"Lawfully residing" means the individual is lawfully present in the United States and also meets Medicaid residency requirements.

"Local office" means the Oklahoma OKDHS' office or offices located in each county within the State.

"LOCEU" means the Oklahoma Health Care Authority's Level of Care Evaluation Unit.

"MAGI eligibility group" means an eligibility group whose financial eligibility is determined through the Modified Adjusted Gross Income (MAGI) methodology. The groups subject to MAGI are defined in 42 C.F.R. _ 436.603 and listed in OAC 317:35-6-1.

"Modified Adjusted Gross Income (MAGI)" means the financial eligibility determination methodology established by the Patient Protection and Affordable Care Act (PPACA) in 2009.

"Medicare" means the federally funded health insurance program also known as Title XVIII of the Social Security Act. It consists of four (4) separate programs. Part A is Hospital Insurance,

Part B is Medical Insurance, Part C is Medicare Advantage Plans, and Part D is Prescription Drug Coverage.

(A) **"Part A Medicare"** means Hospital Insurance that covers services for inpatient services while the patient is in a hospital or nursing facility. Premium free enrollment is provided for all persons receiving Old Age, Survivors, and Disability Insurance (OASDI) or Railroad Retirement income who are age sixty-five (65) or older and for those under age sixty-five (65) who have been receiving disability benefits under these programs for at least twenty-four (24) months.

(i) Persons with end-stage renal disease who require dialysis treatment or a kidney transplant may also be covered.

(ii) Those who do not receive OASDI or Railroad Retirement income must be age sixty-five (65) or over and pay a large premium for this coverage. Under Authority rules, these individuals are not required to enroll for Part A to be eligible for SoonerCare benefits as categorically needy. They must, however, enroll for Medicare Part B. Individuals eligible as a QMBP or as a QDWI under Medicaid are required to enroll for Medicare Part A. The Authority will pay Part A premiums for QMBP individuals who do not qualify for premium free Part A and for all QDWI's.

(B) **"Part B Medicare"** means Supplemental Medical Insurance that covers physician and related medical services other than inpatient or nursing facility care. Individuals eligible to enroll in Medicare Part B are required to do so under OHCA policy. A monthly premium is required to keep this coverage in effect.

"Minor child" means a child under the age of eighteen (18).

"Noncitizen" is synonymous with the word "alien" and means an individual who does not have United States citizenship and is not a United States national.

"Nursing Care" for the purpose of Medicaid Recovery is care received in a nursing facility, an intermediate care facility for individuals with intellectual disabilities (ICF/IIDs) or other medical institution providing nursing and convalescent care, on a continuing basis, by professional personnel who are responsible to the institution for professional medical services.

"OCSS" means the OKDHS' Oklahoma Child Support Services (formerly Child Support Enforcement Division).

"OHCA" means the Oklahoma Health Care Authority.

"OHCA Eligibility Unit" means the group within the OHCA that assists with the eligibility determination process.

"OKDHS" means the Oklahoma Department of Human Services which is also referenced in rules as Department of Human Services (DHS) and Office of Human Services (OHS).

"OKDHS nurse" means a registered nurse in the OKDHS Aging Services Division who meets the certification requirements for UCAT Assessor and case manager, and who conducts the uniform assessment of individuals utilizing the UCAT for the purpose of medical eligibility determination. The OKDHS nurse also develops care plans and service plans for Personal Care services based on the UCAT.

"Qualified Disabled and Working Individual (QDWI)" means individuals who have lost their Title II OASDI benefits due to excess earnings but have been allowed to retain Medicare coverage.

"Qualified Medicare Beneficiary Plus (QMBP)" means certain aged, blind or disabled individuals who may or may not be enrolled in Medicare Part A, meet the Medicaid QMBP income and resource standards and meet all other Medicaid eligibility requirements.

"Qualifying Individual" means certain aged, blind or disabled individuals who are enrolled in Medicare Part A, meet the Medicaid Qualifying Individual income and resource standards and meet all other Medicaid eligibility requirements.

"Qualifying Individual-1" means a Qualified Individual who meets the Qualifying Individual-1 income and resource standards.

"Reasonably compatible" means that there is no significant discrepancy between information declared by a member or applicant and other information available to the agency. More specific policies and procedures for determining whether a declaration is reasonably compatible are detailed in Oklahoma's Verification Plan.

"Recipient lock-in" means when a member is restricted to one primary physician and/or one pharmacy. It occurs when the OHCA determines that a SoonerCare member has used multiple physicians and/or pharmacies in an excessive manner over a twelve (12) month period.

"Scope" means the covered medical services for which payment is made to providers on behalf of eligible individuals. The OHCA Provider Manual (OAC 317:30) contains information on covered medical services.

"Specified Low Income Medicare Beneficiaries (SLMB)" means individuals who, except for income, meet all of the eligibility requirements for QMBP eligibility and are enrolled in Medicare Part A.

"TEFRA" means the Tax Equity and Fiscal Responsibility Act of 1982 (Public Law 97-248). TEFRA provides coverage to certain disabled children living in the home who would qualify for SoonerCare if residents of nursing facilities, Intermediate Care Facilities for Individuals with Intellectual Disabilities (ICF/IIDs), or inpatient acute care hospital stays are expected to last not less than sixty (60) days.

"Worker" means the OHCA or OKDHS worker responsible for assisting in eligibility determinations.

SUBCHAPTER 6. SOONERCARE FOR PREGNANT WOMEN AND FAMILIES WITH CHILDREN

PART 7. CERTIFICATION, REDETERMINATION AND NOTIFICATION

317:35-6-60. Certification for SoonerCare for pregnant women and families with children

(a) General rules of certification.

(1) An individual determined eligible for SoonerCare may be certified for a prospective period of coverage on or after the date of certification.

(2) In accordance with 42 Code of Federal Regulations (C.F.R.) § 435.915 and Oklahoma Administrative Code (OAC) 317:35-6-60.2, an individual may also be determined eligible and certified for a retroactive period of coverage during the three (3) month period directly prior to the date of application. This only applies if the individual received covered medical services at any time during that period, and would have been eligible for SoonerCare at the time he or she received the services, regardless of whether the individual is alive when application for Medicaid is made. An individual may be eligible for the retroactive period even though ineligible for the prospective period.

(3) The individual who is categorically needy and related to pregnancy-related services retains eligibility for the period covering prenatal, delivery, and postpartum periods without regard to eligibility for other household members in the case. Eligibility during the postpartum

period does not apply to women receiving pregnancy-related coverage under Title XXI.

(b) **Certification as a TANF (cash assistance) recipient.** A categorically needy individual who is determined eligible for ~~TANF~~ Temporary Assistance for Needy Families (TANF) is certified effective the first day of the month of TANF eligibility.

(c) **Certification of non-cash assistance individuals related to the children and parent and caretaker relative groups.** The certification period for the individual related to the children or parent and caretaker relative groups is twelve (12) months. The certification period can be less than twelve (12) months if the individual:

(1) Is certified as eligible in a money payment case during the twelve-month (12-month) period;

(2) Is certified for long-term care during the twelve-month (12-month) period;

(3) Becomes ineligible for SoonerCare after the initial month, except for children who are eligible for twelve months continuous coverage; or

(4) Becomes financially ineligible.

(A) If an income change after certification causes the case to exceed the income standard, the case is closed.

(B) Individuals, however, who are determined pregnant and financially eligible continue to be eligible for pregnancy-related services through the prenatal, delivery and postpartum period, regardless of income changes. A pregnant individual included in a TANF case which closes continues to be eligible for pregnancy-related services through the postpartum period.

(d) **Certification of individuals related to pregnancy-related services.** The certification period for the individual related to pregnancy-related services will cover the prenatal, delivery and postpartum periods. The postpartum period is defined as the twelve (12) months following the month the pregnancy ends. Financial eligibility is based on the income received in the first month of the certification period. No consideration is given to changes in income after certification.

(e) **Certification of newborn child deemed eligible.**

(1) Every newborn child is deemed eligible on the date of birth for SoonerCare when the child is born to a woman who is eligible for and enrolled in pregnancy-related services as categorically needy. The newborn child is deemed eligible through the last day of the month the newborn child attains the age of one (1) year. The newborn child's eligibility is not dependent on the mother's continued eligibility. The mother's coverage may expire at the end of the postpartum period; however, the newborn child is deemed eligible until age one (1). The newborn child's eligibility is based on the original eligibility determination of the mother for pregnancy-related services, and consideration is not given to any income or resource changes that occur during the deemed eligibility period.

(2) The newborn child is deemed eligible for SoonerCare as long as he/she continues to live in Oklahoma. In accordance with 42 C.F.R. § 435.117, no other conditions of eligibility are applicable, including social security number enumeration, child support referral, and citizenship and identity verification. However, it is recommended that social security number enumeration be completed as soon as possible after the newborn child's birth. It is also recommended that a child support referral be completed, if needed, as soon as possible and sent to the Oklahoma Child Support Services (OCSS) division at DHS. The referral enables child support services to be initiated.

(3) When a categorically needy newborn child is deemed eligible for SoonerCare, he/she remains eligible through the end of the month that the newborn child reaches age one (1). If

the child's eligibility is moved from the case where initial eligibility was established, it is required that the newborn receive the full deeming period. The certification period is shortened only in the event the child:

- (A) Loses Oklahoma residence; or
- (B) Expires.

(4) A newborn child cannot be deemed eligible when the mother's only coverage was presumptive eligibility, and continued eligibility was not established.

317:35-6-60.1 Changes in circumstances

(a) **Reporting changes.** Members are required to report changes in their circumstances within ~~ten (10)~~ ten (10) days of the date the member is aware of the change.

(b) **Agency action on changes in circumstances.** When the agency responsible for determining eligibility for the member becomes aware of a change in the member's circumstances, the agency will promptly redetermine eligibility for all household members whose eligibility is affected by the change.

(c) **Changes reported by third parties.** When the agency receives information regarding a change in the member's circumstances from a third party, such as the Oklahoma Employment Security Commission (OESC) or the Social Security Administration (SSA), the agency will determine whether the information received is reasonably compatible with the most recent information provided by the member.

(1) If the information received is reasonably compatible with the information provided by the member, the agency will use the information provided by the member for determinations and redeterminations of eligibility.

(2) If the information received is not reasonably compatible with the information provided by the member, the agency will determine whether the information received will have an effect on the eligibility of any member of the household.

(A) If the information received has no effect on the eligibility of any member of the household, including the benefit package the member is enrolled in, the agency will take no action.

(B) If the information received has an effect on the eligibility of a member of the household, the agency will request more information from the member, including, but not limited to, an explanation of the discrepancy or verification documenting the correct information regarding the factor of eligibility affected by the information received from a third party.

(C) The agency will give the member proper notice of at least 10 days to respond to the agency's request for information.

(D) If the member does not cooperate in resolving the discrepancy within the timeframe established by the notice, benefits will be terminated.

~~(d) **Exception January to March, 2014.** During the period January to March, 2014, redeterminations due to changes in circumstances will be processed, but the effective date of any termination action taken as a result of changes in household composition or income for individuals in MAGI eligibility groups will be April 1, 2014, or later.~~

(d) **Changes in a continuous eligibility period for children.** During a continuous eligibility period for children, a member must report:

(1) A change of address for the child; or

(2) If a certified child leaves the home, is institutionalized, or dies.

317:35-6-61. Redetermination of eligibility for persons receiving SoonerCare

(a) A periodic redetermination of eligibility for SoonerCare is required for all members. The redetermination is made prior to the end of the initial certification period and each ~~12~~twelve (12) months thereafter. A deemed newborn is eligible through the last day of the month the newborn child attains the age of one year, without regard to eligibility of other household members in the case.

(b) Effective January 1, 2014, when the agency has sufficient information available electronically to redetermine eligibility, eligibility will be redetermined on that basis and a notice will be sent to the household explaining the action taken by the agency. The member is responsible for notifying the agency if any information used to redetermine eligibility is incorrect. If the agency does not have sufficient information to redetermine eligibility, the agency will send notice to that effect, and the member is responsible for providing the necessary information to redetermine eligibility.

(c) A member's case is closed if he/she does not return the form(s) and any verification necessary for redetermination timely. If the member submits the form(s) and verification necessary for redetermination within ~~90~~ninety (90) days after closure of the case, benefits are reopened effective the date of the closure, provided the member is eligible and benefits were closed because the redetermination process was not completed.

~~(d) Periodic redeterminations scheduled for January to March, 2014 will be rescheduled for April, 2014.~~

(d) Effective January 1, 2024, a child who meets the criteria for continuous eligibility shall remain eligible for SoonerCare, until the earlier of:

- (1) Twelve (12) months from the effective date of the child's most recent certification period;
- or
- (2) The child's nineteenth (19th) birthday.

317:35-7-16. Special application procedures for children in OKDHS custody

The rules in this section apply when determining eligibility for health benefits for children who are reported by OKDHS as being in custody.

(1) When a child placed in custody as reported by OKDHS remains in the parent's home and there is not an active medical case;

~~(A) The~~the OKDHS child welfare specialist advises the family that an application for medical services may be made at the local OKDHS office of available medical resources and refers the parent(s) to SoonerCare to apply for medical assistance. Application for children receiving Supplemental Security Income must be made in the local OKDHS office.

~~(B) The OKDHS Family Support Services (FSS) worker is responsible for processing the SC-1, SoonerCare Health Benefits application or FSS-1, Comprehensive Application and Review, whichever is appropriate.~~

(2) When a child placed in custody as reported by OKDHS has an active case and a change in placement is made to a home or facility outside the parent's home:

~~(A) The OKDHS child welfare specialist completes Form CWS-KIDS-4, Eligibility Determination, and forwards it to the OKDHS custody specialist advising of this change, including the date the child was placed outside the home~~enters the child's removal information into the Child Abuse and Neglect Information System (KIDS) Removal

screen, which generates an assignment to the custody specialist for Title XIX medical benefits. This referral is made within five working days of the placement.

(B) The OKDHS custody specialist makes the appropriate change to remove the child from the family case and opens a child only case the next effective date.

(3) When a child in custody as reported by OKDHS is placed outside the home and there is not an active case, the OKDHS child welfare specialist ~~is responsible for completing and forwarding the CWS-KIDS 4, Eligibility Determination,~~ enters the child's removal information into the Child Abuse and Neglect Information System (KIDS) Removal screen, which generates an assignment to the OKDHS custody specialist. This referral is made ~~The CWS-KIDS 4 must be sent~~ within five working days of removal from the home. The date of application is the date the child is placed in custody. The OKDHS custody specialist is responsible for processing the application.

(4) When a child in custody as reported by OKDHS placed outside the home is later returned to the home but remains in custody:

(A) The OKDHS child welfare specialist ~~advises forwards Form K-13 to the OKDHS custody specialist advising of the change in placement.~~ The OKDHS child welfare specialist advises the family ~~that a Medicaid application may be made at the local OKDHS office for medical benefits to continue, if the family meets eligibility criteria~~ of available medical resources and refers the parent(s) to SoonerCare to apply for medical assistance. Application for children receiving Supplemental Security Income must be made in the local OKDHS office.

(B) ~~The OKDHS custody specialist is responsible for sending a SC-1 to the family so the child's Medicaid eligibility can be redetermined. If the family does not return the completed SC-1, the OKDHS custody specialist closes the child's Medicaid case. The child remains continuously eligible for the remainder of the certification period, as defined at OAC 317:35-1-2, pursuant to 42 U.S.C. 1396a(e)(12).~~

(5) When a child in custody as reported by OKDHS and living in an out of home placement attains age 18, he/she may still be eligible for medical benefits until the age of 21 under the Foster Care Independence Act if his/her income is below the standard on OKDHS Appendix C-1, Schedule 1.A. The individual must complete a new application and have eligibility redetermined in accordance with OAC 317:35-6.

This page intentionally left blank

**TITLE 317. OKLAHOMA HEALTH CARE AUTHORITY
CHAPTER 30. MEDICAL PROVIDERS-FEE FOR SERVICE**

SUBCHAPTER 3. GENERAL PROVIDER POLICIES

PART 3. GENERAL MEDICAL PROGRAM INFORMATION

317:30-3-62. ~~Serious reportable events – never events~~ Provider Preventable Conditions

(a) **Definitions.** The following words and terms, when used in this Section, have the following meaning, unless the context clearly indicates otherwise.

(1) ~~"Surgical and other invasive procedures"~~ are defined as operative procedures in which skin or mucous membranes and connective tissues are incised or an instrument is introduced through a natural body orifice. Invasive procedures include a range of procedures from minimally invasive dermatological procedures (biopsy, excision, and deep cryotherapy for malignant lesions) to extensive multi-organ transplantation. They include all procedures described by the codes in the surgery section of the Current Procedural Terminology (CPT) and other invasive procedures such as percutaneous transluminal angioplasty and cardiac catheterization. They include minimally invasive procedures involving biopsies or placement of probes or catheters requiring the entry into a body cavity through a needle or trocar. They do not include use of instruments such as otoscopes for examinations or very minor procedures such as drawing blood.

(2) A surgical or other invasive procedure is considered to be the wrong procedure if it is not consistent with the correctly documented informed consent for that member.

(3) A surgical or other invasive procedure is considered to have been performed on the wrong body part if it is not consistent with the correctly documented informed consent for that member including surgery on the right body part, but on the wrong location on the body; for example, left versus right (appendages and/or organs), or at the wrong level (spine).

(4) A surgical or other invasive procedure is considered to have been performed on the wrong member if that procedure is not consistent with the correctly documented informed consent for that member.

(b) **Coverage.** The Oklahoma Health Care Authority (OHCA) will no longer cover a particular surgical or other invasive procedure to treat a particular medical condition when the practitioner erroneously performs (1) a different procedure altogether; (2) the correct procedure but on the wrong body part; or (3) the correct procedure but on the wrong member. SoonerCare will not cover hospitalizations or any services related to these non-covered procedures. All services provided in the operating room when an error occurs are considered related and therefore not covered. All providers in the operating room when the error occurs, who could bill individually for their services, are also not eligible for payment. All related services provided during the same hospitalization in which the error occurred are not covered. A provider cannot shift financial liability or responsibility for the non-covered services to the member if the OHCA has determined that the service is related to one of the above erroneous surgical procedures.

(c) **Billing.** For inpatient claims, hospitals are required to bill two claims when the erroneous surgery is reported, one claim with covered services or procedures unrelated to the erroneous surgery, the other claim with the non-covered services or procedures as a no-payment claim. For outpatient and practitioner claims, providers are required to append the applicable HCPCS modifiers to all lines related to the erroneous surgery. Claim lines submitted with one of the applicable HCPCS modifiers will be line-item denied.

~~(d) **Related claims.** Once a claim for the erroneous surgery(s) has been received, OHCA may review member history for related claims as appropriate. Incoming claims for the identified member may be reviewed for an 18-month period from the date of the surgical error. If such claims are identified to be related to the erroneous surgical procedure(s), OHCA may take appropriate action to deny such claims and recover any overpayments on claims already processed.~~

~~(e) **Dually eligible members.** SoonerCare will not act as a secondary payer for Medicare non-payment of the aforementioned erroneous surgery(s).~~

~~(f) **Hospital acquired conditions.** SoonerCare will not reimburse the extra cost of treating certain categories of conditions that occur while a member is in the hospital. See OAC 317:30-3-63 for specific information regarding hospital acquired conditions.~~

(a) **Definitions.** The following words and terms, when used in this Section, have the following meaning, unless the context clearly indicates otherwise.

(1) **"Health care-acquired conditions (HCAC)"** means a condition occurring in any inpatient hospital setting, (identified as a hospital acquired condition by federal regulation and Medicare; other than deep vein thrombosis/pulmonary embolism as related to a total knee replacement or hip replacement surgery in pediatric and obstetric patients.) Medicare's list of hospital acquired conditions is also available at: http://www.cms.gov/Medicare/Medicare-Fee-for-Service-Payment/HospitalAcqCond/Hospital-Acquired_Conditions.html.

(2) **"National Quality Forum (NQF)"** means the independent, nonpartisan organization tasked with devising a national strategy to set standards for quality improvement and reporting in the healthcare industry.

(3) **"Other provider preventable conditions (OPPC)"** means the list of serious reportable events in health care as identified by this Section and published by the NQF.

(4) **"Present on admission (POA) indicator"** means a status code the hospital uses on an inpatient claim that indicates if a condition was present at the time the order for inpatient admission occurs.

(5) **"Provider preventable condition (PPC)"** means a condition that meets the definition of a "health care-acquired condition" or an "other provider-preventable condition" as defined in this Section.

(b) Health care-acquired conditions (HCAC)

(1) **Payment policy.** In accordance with 42 C.F.R § 447.26, the Oklahoma Health Care Authority (OHCA) will not reimburse health care professionals and inpatient hospitals for the increased incremental cost of inpatient care services that result when a member is harmed by one (1) of the HCACs listed below.

(A) Foreign object retained after surgery;

(B) Air embolism;

(C) Blood incompatibility;

(D) Pressure ulcer stages III & IV;

(E) Falls and trauma; including:

(i) Fracture;

(ii) Dislocation;

(iii) Intracranial injury;

(iv) Crushing injury;

(v) Burn;

(vi) Electric shock;

(F) Catheter-associated urinary tract infection;

(G) Vascular catheter-associated infection;

(H) Manifestations of poor glycemic control; including:

- (i) Diabetic ketoacidosis;
- (ii) Nonketotic hyperosmolar coma;
- (iii) Hypoglycemic coma;
- (iv) Secondary diabetes with ketoacidosis;
- (v) Secondary diabetes with hyperosmolarity;
- (I) Surgical site infection following:
 - (i) Coronary artery bypass graft-mediastinitis;
 - (ii) Bariatric surgery; including:
 - (I) Laparoscopic gastric bypass;
 - (II) Gastroenterostomy;
 - (III) Laparoscopic gastric restrictive surgery;
 - (iii) Orthopedic procedures; including:
 - (I) Spine;
 - (II) Neck;
 - (III) Shoulder;
 - (IV) Elbow;
 - (iv) Cardiac implantable electronic device (CIED)
- (J) Deep vein thrombosis and pulmonary embolism following:
 - (i) Total knee replacement with exceptions for pediatric and/or obstetric cases; or
 - (ii) Hip replacement with exceptions for pediatric and/or obstetric cases.

(K) Iatrogenic pneumothorax with venous catheterization

(2) **Billing.** Hospitals paid under the diagnosis related grouping (DRG) methodology are required to submit a POA indicator for the principal diagnosis code and every secondary diagnosis code for all discharges. A valid POA indicator is required on all inpatient hospital claims. Claims with no valid POA indicator will be denied. For all claims involving inpatient admissions, OHCA will group diagnoses into the proper DRG using the POA indicator. If a provider in either a fee-for-service or managed care delivery system receives SoonerCare reimbursement for the increased incremental cost of inpatient care services that result when a member is harmed by the HCACs identified in (b)(1) (A)-(K), the provider shall reimburse those costs to the Agency or Contracted Entity.

(3) **Dually eligible members.** SoonerCare will not act as a secondary payer for Medicare non-payment of HCACs.

(c) Other provider preventable condition (OPPC)

(1) **Payment policy.** In accordance with 42 C.F.R § 447.26, the Agency will not reimburse health care professionals and inpatient hospitals for care related to the treatment of consequences of an OPPC when the condition:

- (A) Is identified in the Oklahoma Medicaid State Plan;
- (B) Has been found by the State, based upon a review of medical literature by qualified professionals, to be reasonably preventable through the application of procedures supported by evidence-based guidelines;
- (C) Is within the control of the hospital;
- (D) Has a negative consequence for the member;
- (E) Is auditable; and
- (F) Is included on the list of serious reportable events in health care by the National Quality Forum (NQF). Providers are responsible for keeping abreast of any changes to the list of serious reportable events identified by the NQF. The list of serious reportable events in health care, as of the publishing of this rule, includes surgical or invasive procedure events:

- (i) Surgical or other invasive procedure performed on the wrong site;
- (ii) Surgical or other invasive procedure performed on the wrong patient;
- (iii) Wrong surgical or other invasive procedure performed on a patient;

(2) **Billing.** For inpatient claims, hospitals are required to bill two (2) claims when the erroneous surgery is reported, one (1) claim with covered services or procedures unrelated to the erroneous surgery, the other claim with the non-covered services or procedures as a no-payment claim. For outpatient and practitioner claims, providers are required to append the applicable Healthcare Common Procedure Coding System (HCPCS) modifiers to all lines related to the erroneous surgery. Claim lines submitted with one (1) of the applicable HCPCS modifiers will be line-item denied. If a provider in either a fee-for-service or managed care delivery system receives SoonerCare reimbursement for patient care or treatment directly related to an identifiable provider-preventable condition that was not present when the individual initiated treatment with that provider, the provider shall reimburse those costs to the Agency or Contracted Entity.

(3) **Related claims.** Once a claim for the erroneous surgery(s) has been received, OHCA may review member history for related claims as appropriate. Incoming claims for the identified member may be reviewed for an eighteen-month (18-month) period from the date of the surgical error. If such claims are identified to be related to the erroneous surgical procedure(s), OHCA may take appropriate action to deny such claims and recover any overpayments on claims already processed.

(4) **Dually eligible members.** SoonerCare will not act as a secondary payer for Medicare non-payment of OPPCs.

(d) **Reporting.** Title 42 of the Code of Federal Regulations, Sections 447, 434 and 438 require providers, in both fee-for-service and managed care delivery systems, to report all PPCs that are associated with claims for SoonerCare payment or with courses of treatment furnished to a SoonerCare member for which Medicaid payment would otherwise be available. The report shall be made to the OHCA regardless of whether the provider seeks SoonerCare reimbursement for services to treat the PPCs. The Agency report form is available for download at <https://oklahoma.gov/ohca>. Providers must report the following information to the OHCA within 10 days of the occurrence of the event:

- (1) Member name and member ID number.
- (2) A description of the event.
- (3) Dates of services and occurrence of the event.
- (4) Attending physician(s).
- (5) Facility.

(e) **Liability.** A provider cannot shift financial liability or responsibility for the non-covered services and treatment to the member if the OHCA has determined that the service is related to a PPC.

317:30-3-63. Hospital acquired conditions [REVOKED]

~~(a) **Coverage.** The Oklahoma Health Care Authority (OHCA) will no longer reimburse the extra cost of treating certain categories of conditions that occur while a member is in the hospital. For discharges, hospitals will not receive additional payment for cases in which one of the selected conditions was not present on admission. The claim will be grouped to a DRG as if the diagnosis was not present on the claim. The selected conditions that OHCA recognizes are those conditions identified as non-payable by Medicare. OHCA may revise through addition or deletion the selected conditions at any time during the fiscal year. The following is a complete list of the hospital acquired conditions (HACs) currently recognized by OHCA:~~

- ~~(1) Foreign Object Retained After Surgery~~
- ~~(2) Air Embolism~~

- (3) Blood Incompatibility
- (4) Pressure Ulcer Stages III & IV
- (5) Falls and Trauma
 - (A) Fracture
 - (B) Dislocation
 - (C) Intracranial Injury
 - (D) Crushing Injury
 - (E) Burn
 - (F) Electric Shock
- (6) Catheter-Associated Urinary Tract Infection
- (7) Vascular Catheter-Associated Infection
- (8) Manifestations of Poor Glycemic Control
 - (A) Diabetic Ketoacidosis
 - (B) Nonketotic Hyperosmolar Coma
 - (C) Hypoglycemic Coma
 - (D) Secondary Diabetes with Ketoacidosis
 - (E) Secondary Diabetes with Hyperosmolarity
- (9) Surgical Site Infection Following:
 - (A) Coronary Artery Bypass Graft– Mediastinitis
 - (B) Bariatric Surgery
 - (i) Laparoscopic Gastric Bypass
 - (ii) Gastroenterostomy
 - (iii) Laparoscopic Gastric Restrictive Surgery
 - (C) Orthopedic Procedures
 - (i) Spine
 - (ii) Neck
 - (iii) Shoulder
 - (iv) Elbow
- (10) Deep Vein Thrombosis and Pulmonary Embolism
 - (A) Total Knee Replacement
 - (B) Hip Replacement

(b) **Billing.** Hospitals paid under the diagnosis related grouping (DRG) methodology are required to submit a present on admission (POA) indicator for the principal diagnosis code and every secondary diagnosis code for all discharges. A valid POA indicator is required on all inpatient hospital claims. Claims with no valid POA indicator will be denied. For all claims involving inpatient admissions, OHCA will group diagnoses into the proper DRG using the POA indicator.

(c) **Dually eligible members.** SoonerCare will not act as a secondary payer for Medicare non-payment of the aforementioned hospital acquired conditions.

This page intentionally left blank

TITLE 317. OKLAHOMA HEALTH CARE AUTHORITY
CHAPTER 30. MEDICAL PROVIDERS-FEE FOR SERVICE
SUBCHAPTER 5. INDIVIDUAL PROVIDERS AND SPECIALTIES
PART 5. PHARMACIES

317:30-5-72. Categories of service eligibility

(a) **Coverage for adults.** Prescription drugs for categorically needy adults are covered as set forth in this subsection.

(1) With the exception of (2) and (3) of this subsection, categorically needy adults are eligible for a maximum of six (6) covered prescriptions per month with a limit of two (2) brand name prescriptions. A prior authorization may be granted for a third brand name if determined to be medically necessary by OHCA and if the member has not already utilized their six (6) covered prescriptions for the month.

(2) Subject to the limitations set forth in Oklahoma Administrative Code (OAC) 317:30-5-72.1, 317:30-5-77.2, and 317:30-5-77.3, exceptions to the six (6) medically necessary prescriptions per month limit are:

(A) Unlimited monthly medically necessary prescriptions for categorically related individuals who are residents of nursing facilities (NF) or intermediate care facilities for individuals with an intellectual disability (ICF/IID); and

(B) Seven (7) additional medically necessary prescriptions which are generic products per month to the six (6) covered under the State Plan [including three (3) brand name prescriptions] are allowed for adults receiving services under the 1915(c) Home and Community-Based Services (HCBS) waivers. Medically necessary prescriptions beyond the three (3) brand name or thirteen (13) total prescriptions will be covered with prior authorization.

(3) For purposes of this Section, "exempt from the prescription limit" means claims filed for any of these prescriptions will not count toward the prescriptions allowed per month. Drugs exempt from the prescription limit include:

(A) Antineoplastics;

(B) Anti-retroviral agents for persons diagnosed with Acquired Immune Deficiency Syndrome (AIDS) or who have tested positive for the Human Immunodeficiency Virus (HIV);

(C) Frequently monitored prescription drugs. A complete list of the selected drugs considered as frequently monitored can be viewed on the agency's website at www.okhca.org.

(D) Medication-assisted treatment (MAT) drugs for opioid use disorder;

(E) Contraceptives;

(F) Hemophilia drugs;

(G) Compensable smoking and tobacco cessation products;

(H) ~~Naloxone for use in opioid overdose~~ Opioid overdose reversal agents;

(I) Certain carrier or diluent solutions used in compounds (i.e., sodium chloride, sterile water, etc.);

(J) Drugs used for the treatment of tuberculosis; and

(K) Prenatal vitamins.

(4) When a brand drug is preferred over its generic equivalent due to lower net cost, that drug

shall not count toward the brand limit; however, it will count toward the monthly prescription limit.

(b) **Coverage for children.** Prescription drugs for SoonerCare eligible individuals under twenty-one (21) years of age are not limited in number per month, but may be subject to prior authorization, quantity limits or other restrictions.

(c) **Individuals eligible for Part B of Medicare.** Individuals eligible for Part B of Medicare are also eligible for the Medicare Part D prescription drug benefit. Coordination of benefits between Medicare Part B and Medicare Part D is the responsibility of the pharmacy provider. The SoonerCare pharmacy benefit does not include any products which are available through either Part B or Part D of Medicare.

(d) **Individuals eligible for a prescription drug benefit through a Prescription Drug Plan (PDP) or Medicare Advantage - Prescription Drug (MA-PD) plan as described in the Medicare Modernization Act (MMA) of 2003.** Individuals who qualify for enrollment in a PDP or MA-PD are specifically excluded from coverage under the SoonerCare pharmacy benefit. This exclusion applies to these individuals in any situation which results in a loss of Federal Financial Participation for the SoonerCare program. This exclusion shall not apply to items covered at OAC 317:30-5-72.1(2) unless those items are required to be covered by the prescription drug provider in the MMA or subsequent federal action.

**TITLE 317. OKLAHOMA HEALTH CARE AUTHORITY
CHAPTER 30. MEDICAL PROVIDERS-FEE FOR SERVICE**

SUBCHAPTER 5. INDIVIDUAL PROVIDERS AND SPECIALTIES

PART 75. FEDERALLY QUALIFIED HEALTH CENTERS

317:30-5-660.3. Health Center enrollment requirements for specialty behavioral health services

~~(a)~~ For the provision of behavioral health related case management services and psychosocial rehabilitation services, Health Centers must contract as an outpatient behavioral health agency and meet the requirements found at OAC 317:30-5-241.3 and 317:30-5-241.6.

~~(b)~~ Health Centers which provide substance use treatment services must also be certified by the Oklahoma Department of Mental Health and Substance Abuse Services (ODMHASAS)

This page intentionally left blank

**TITLE 317. OKLAHOMA HEALTH CARE AUTHORITY
CHAPTER 35. MEDICAL ASSISTANCE FOR ADULTS AND CHILDREN-
ELIGIBILITY**

SUBCHAPTER 23. LIVING CHOICE PROGRAM

317:35-23-2. Eligibility criteria

Adults with disabilities or long-term illnesses, members with intellectual disabilities and members with physical disabilities are eligible to transition into the community through the Living Choice program if they meet all of the criteria in paragraphs (1) through (7) of this subsection.

- (1) He/she must be at least nineteen (19) years of age.
- (2) He/she must reside in a nursing facility, skilled nursing facility, ~~or a~~ qualified long term care facility, or a public or private Intermediate Care Facility for Individuals with Intellectual Disabilities (ICF/IID) for at least sixty (60) consecutive days prior to the proposed transition date. ~~If any portion of the sixty (60) days includes time in a skilled nursing facility, those days cannot be counted toward the sixty (60) day requirement, if the member received Medicare post-hospital extended care rehabilitative services.~~
- (3) He/she must have at least one (1) day of Medicaid paid long-term care services prior to transition.
- (4) If transitioning from an out of state institution, he/she must be SoonerCare eligible.
- (5) He/she requires at least the same level of care that necessitated admission to the institution.
- (6) He/she must reside in a qualified residence after leaving the institution. A qualified residence is defined in (A) through (C) of this paragraph.
 - (A) a home owned or leased by the individual or the individual's family member;
 - (B) an apartment with an individual lease, with a locking entrance/exit, and which includes living, sleeping, bathing, and cooking areas over which the individual or the individual's family has domain and control; and
 - (C) a residence, in a community-based residential setting, in which no more than four (4) unrelated individuals reside.
- (7) His/her needs can be met by the Living Choice program while living in the community.
- (8) He/she must not be a resident of a nursing facility or ICF/IID in lieu of incarceration.

This page intentionally left blank

**TITLE 317. OKLAHOMA HEALTH CARE AUTHORITY
CHAPTER 2. GRIEVANCE PROCEDURES AND PROCESS**

SUBCHAPTER 1. ADMINISTRATIVE APPEALS

317:2-1-2. Appeals

(a) Request for appeals.

(1) For the purpose of calculating the timeframe for requesting an administrative appeal of an ~~agency~~Agency action, the date on the written notice shall not be included. The last day of the timeframe shall be included, unless it is a legal holiday as defined by Title 25 of the Oklahoma Statutes (O.S.) Section (§) 82.1, or any other day the Oklahoma Health Care Authority (OHCA) is closed or closes early, in which case, the timeframe runs until the close of the next full business day.

(2) An appeals request that an aggrieved member or provider sends via mail is deemed filed on the date that the ~~agency~~Agency receives it.

(b) Member process overview.

(1) The appeals process allows a member to appeal a decision relating to program benefits. Examples are decisions involving medical services, prior authorizations for medical services, or discrimination complaints.

(2) In order to initiate an appeal, the member must file a LD-1 (Member Complaint/Grievance Form) within thirty (30) calendar days of the date the OHCA sends written notice of its action, in accordance with Oklahoma Administrative Code (OAC) 317:2-1-2(a), above, or, in matters in which a formal notice is not sent by the ~~agency~~Agency, within thirty (30) days of the date on which the member knew or should have known the facts or circumstances serving as the basis for appeal.

(3) If the LD-1 form is not received timely, the OHCA administrative law judge (ALJ) will cause to be issued a letter stating the appeal will not be heard. In the case of tax warrant intercept appeals, if the LD-1 form is not received by OHCA within the timeframe pursuant to 68 O.S. § 205.2, OHCA similarly will cause to be issued a letter stating the appeal will not be heard because it is untimely.

(4) If the LD-1 form is not completely filled out or if necessary, documentation is not included, then the appeal will not be heard.

(5) OHCA will advise members that if assistance is needed in reading or completing the grievance form, arrangements will be made to provide such assistance.

(6) Upon receipt of the member's appeal, a fair hearing before the OHCA ALJ will be scheduled. The member will be notified in writing of the date and time of the hearing. The member, and/or his/her designated authorized ~~representative~~representative, must appear at the hearing, either in person or telephonically. The preferred method for a hearing is telephonically, requests for an in-person hearing must be received in writing on OHCA's Form LD-4 (Request for In-Person Hearing) no later than ten (10) calendar days prior to the scheduled hearing date.

(7) The hearing shall be conducted according to OAC 317:2-1-5. The OHCA ALJ's decision may in certain instances be appealed to the CEO of the OHCA, or his or her designated independent ALJ, which is a record review at which the parties do not appear (OAC 317:2-1-13).

(8) Member appeals are ordinarily decided within ninety (90) days from the date on which the member's timely request for a fair hearing is received, unless:

(A) The appellant was granted an expedited appeal pursuant to OAC 317:2-1-2.5;

(B) The OHCA cannot reach a decision because the appellant requests a delay or fails to

take a required action, as reflected in the record;

(C) There is an administrative or other emergency beyond OHCA's control, as reflected in the record; or

(D) The appellant filed a request for an appeal of a denied step therapy exception request, pursuant to OAC 317:2-1-18.

(9) Tax warrant intercept appeals will be heard directly by the OHCA ALJ. A decision is normally rendered by the OHCA ALJ within twenty (20) days of the hearing.

(c) Provider process overview.

(1) The proceedings as described in this subsection contain the hearing process for those appeals filed by providers. These appeals encompass all subject matter cases contained in OAC 317:2-1-2(d)(2).

(2) All provider appeals are initially heard by the OHCA ALJ under OAC 317:2-1-2(d)(2).

(A) In order to initiate an appeal, a provider must file the appropriate LD form within thirty (30) calendar days of the date the OHCA sends written notice of its action, in accordance with OAC 317:2-1-2(a), above. LD-2 forms should be used for Program Integrity audit appeals; LD-3 forms are to be used for all other provider appeals.

(B) Except for OHCA Program Integrity audit appeals, if the appropriate LD form is not received timely, the OHCA ALJ will cause a letter to be issued stating that the appeal will not be heard.

(C) A decision ordinarily will be issued by the OHCA ALJ within forty-five (45) days of the close of all evidence in the appeal.

(D) Unless otherwise limited by OAC 317:2-1-7 or 317:2-1-13, the OHCA ALJ's decision is appealable to OHCA's CEO, or his or her designated independent ALJ.

(d) OHCA ALJ jurisdiction. The OHCA ALJ has jurisdiction of the following matters:

(1) Member appeals.

(A) Discrimination complaints regarding the SoonerCare program;

(B) Appeals which relate to the scope of services, covered services, complaints regarding service or care, enrollment, disenrollment, and reenrollment in the SoonerCare ~~Program~~ program;

(C) Fee-for-service appeals regarding the furnishing of services, including prior authorizations;

(D) Appeals which relate to the tax warrant intercept system through the OHCA. Tax warrant intercept appeals will be heard directly by the OHCA ALJ. A decision will be rendered by the OHCA ALJ within twenty (20) days of the hearing;

(E) Proposed administrative sanction appeals pursuant to OAC 317:35-13-7. Proposed administrative sanction appeals will be heard directly by the OHCA ALJ. A decision by the OHCA ALJ will ordinarily be rendered within twenty (20) days of the hearing. This is the final and only appeals process for proposed administrative sanctions;

(F) Appeals which relate to eligibility determinations made by OHCA;

(G) Appeals of insureds participating in Insure Oklahoma which are authorized by OAC 317:45-9-8;

(H) Appeals which relate to a requested step therapy protocol exception as provided by 63 O.S. § 7310; and

(I) Requests for ~~State~~ state fair hearing arising from a member's appeal of a ~~managed care~~ CE or DBM adverse benefit determination.

(2) Provider appeals.

(A) Whether Pre-admission Screening and Resident Review (PASRR) was completed as required by law;

- (B) Denial of request to disenroll member from provider's SoonerCare Choice panel;
- (C) Appeals by long-term care facilities for administrative penalty determinations as a result of findings made under OAC 317:30-5-131.2(b)(5)(B) and (d)(8);
- (D) Appeals of Professional Service Contract awards and other matters related to the Central Purchasing Act pursuant to Title 74 O.S. § 85.1 et seq.;
- (E) Drug rebate appeals;
- (F) Provider appeals of OHCA Program Integrity audit findings pursuant to OAC 317:2-1-7. This is the final and only appeals process for appeals of OHCA Program Integrity audit findings;
- (G) Oklahoma Electronic Health Records Incentive program appeals related only to incentive payments, incentive payment amounts, provider eligibility determinations, and demonstration of adopting, implementing, upgrading, and meaningful use eligibility for incentives;
- (H) Supplemental Hospital Offset Payment Program (SHOPP) annual assessment, supplemental payment, fees, or penalties as specifically provided in OAC 317:2-1-15; and
- (I) Appeals from any adjustment made to a long-term care facility's cost report pursuant to OAC 317:30-5-132, including any appeal following a request for reconsideration made pursuant to OAC 317:30-5-132.1.
- ~~(J) Request for a State fair hearing arising from provider's appeal of managed care audit findings, for cause or immediate termination of the provider's managed care contract, or managed care claims denial.~~

317:2-1-2.6. Continuation of benefits or services pending appeal

- (a) In accordance with Section 431.230 of Title 42 of the Code of Federal Regulations, if an ~~Appellant~~appellant submits a written request for a hearing within ~~ten (10)~~sixty (60) days of the notice of the adverse ~~agency~~Agency action, the ~~Appellant~~appellant may also request that existing benefits or services (hereinafter, collectively referred to as "services") be continued or reinstated until the earlier of dismissal of the appeal, ~~Appellant's~~sappellant's withdrawal of the appeal, or an initial hearing decision adverse to the ~~Appellant~~appellant.
- (b) If the ~~Appellant~~appellant fails to indicate a preference as to continuation or reinstatement of services in a written request for hearing made within ~~ten (10)~~sixty (60) days of the notice of the adverse ~~agency~~Agency action, services shall be continued or reinstated. Provided, however, that a SoonerCare member shall not be entitled to continuation or reinstatement of services pending an appeal related to the following:
 - (1) When a service is denied because the member has exceeded the limit applicable to that service;
 - (2) When a request for a prior authorization is denied for a prescription drug. However:
 - (A) The Oklahoma Health Care Authority (OHCA) may authorize a single seventy-two (72) hour emergency supply of the drug, in accordance with Oklahoma Administrative Code (OAC) 317:30-5-77.2;
 - (B) A SoonerCare provider may initiate a step therapy exception request on behalf of a member, in accordance with OAC 317:30-5-77.4;
 - (3) When coverage of a prescription drug or service is denied because the requested drug or service is not a category or class of drugs or services covered by OHCA;
 - (4) When coverage for a prescription drug is denied because the ~~enrollee~~Enrollee has been locked into one (1) pharmacy and the member seeks to fill a prescription at another pharmacy; or
 - (5) When a physician or other licensed health care practitioner has failed to prescribe or order

the service or level of service for which continuation or reinstatement is requested.
(c) ~~If services are continued or reinstated during the appeals process and the hearing is not decided in the Appellant's favor, OHCA may seek to recover reimbursement of all services received pending the hearing decision.~~

SUBCHAPTER 3. MEMBER GRIEVANCES AND APPEALS, PROVIDER COMPLAINTS, AND STATE FAIR HEARINGS IN ~~MANAGED-~~ CARE SOONERSELECT

317:2-3-1. Definitions

The following words or terms used in the Subchapter shall have the following meaning, unless the context clearly indicates otherwise:

"Adverse benefit determination" means a determination by a health carrier or its designee utilization review organization that an admission, availability of care, continued stay, or other health care service that is a covered benefit has been reviewed and, based upon the information provided, does not meet the health carrier's requirements for medical necessity, appropriateness, health care setting, level of care or effectiveness, and the requested service or payment for the service is therefore denied, reduced or terminated and in accordance with Title 36 of Oklahoma Statute (O.S.) § 6475.3.

"Appeal" means a review of an adverse benefit determination performed by a ~~managed care entity~~ CE or DBM or according to managed care law, regulations, and contracts.

"C.F.R." means the Code of Federal Regulations.

"Contracted entity" or "CE" means an organization or entity that enters into or will enter into a capitated contract with the Oklahoma Health Care Authority (OHCA) for the delivery of services that will assume financial risk, operational accountability, and state-wide or regional functionality in this act in managing comprehensive health outcomes of Medicaid members. This includes an accountable care organization, a provider-led entity, a commercial plan, a dental benefit manager, or any other entity as determined by the OHCA.

"Dental benefits manager" or "DBM" means an entity that meets the definition of a Prepaid Ambulatory Health Plan (PAHP) as per 42 C.F.R. § 438.2 and is under contract with the OHCA to manage and deliver all services described in this SoonerSelect Dental Contract and who handles claims payment and prior authorizations and coordinates dental care with participating providers and Enrollees. Also referred to as a "Contractor".

"Exigent circumstances" means a situation in which a reasonable person applying the appropriate standard would consider a member's health condition to be urgent with identifiable harm that could reasonably be expected to occur if the requested health care service is not provided promptly. The appropriate standard requires the assessment of a member's health condition through application, at minimum, of established, accepted standards of medical practice. Evidence of the member's condition may be demonstrated by indications from the treating provider or from the member's medical record, including but not limited to such information as the member's diagnosis, symptoms, or test results.

"Grievance" means a member's expression of dissatisfaction about any ~~managed care program~~ matter other than an adverse benefit determination and may include, but is not limited to, the quality of care or services provided, aspects of interpersonal relationships such as rudeness of a ~~managed care~~ contracted entity employee or contracted provider, or failure to respect the ~~member's~~ Enrollee's rights regardless of whether remedial action is requested. A grievance includes a ~~member's~~ Enrollee's right to dispute an extension of time to make an authorization decision when proposed by the ~~managed care entity~~ Contractor.

"Health plan" means any person or entity that is licensed as a health maintenance organization (HMO) by the State of Oklahoma to provide or arrange for the delivery of basic health care services to ~~enrollees~~Enrollees on a prepaid basis, except for copayments or deductibles for which ~~enrollee~~Enrollee is responsible, or both, that meets the definition of an HMO as delineated in the Oklahoma State Medicaid Plan and that contracts with the ~~State~~state to provide services to ~~enrollees~~Enrollees. "Health plan" is synonymous with "health carrier".

~~"Managed care entity" or "MCE" means any entity permitted under 42 C.F.R. Part 438 to contract with a state for services provided under a risk contract or a nonrisk contract within the state's Medicaid managed care program, including but not limited to managed care organization (MCO), primary care case management (PCCM), primary care case management entity (PCCM entity), prepaid ambulatory health plan (PAHP), and prepaid inpatient health plan (PIHP).~~

~~"Managed care organization" or "MCO" means the same in these rules as defined at 42 Code of Federal Regulations (C.F.R.) § 438.2.~~

~~"Managed care program" or "managed care" or "MCP" means a health care delivery system organized to manage cost, utilization, and quality that is operated by a state as authorized under sections 1915(a), 1915(b), 1932(a), or 1115(a) of the Social Security Act and relevant state law.~~

"Member" means an individual eligible for Medicaid in the State of Oklahoma, eligible for a managed care program, and enrolled in a ~~managed care entity~~CE or DBM. "Member" is synonymous with "~~health plan enrollee~~Enrollee".

"OAC" means the Oklahoma Administrative Code.

"OHCA" means the Oklahoma Health Care Authority.

"O.S." means the Oklahoma Statutes.

"Prepaid ambulatory health plan" or "PAHP" means the same in these rules as defined at 42 C.F.R. § 438.2.

"Prepaid inpatient health plan" or "PIHP" means the same in these rules as defined at 42 C.F.R. § 438.2.

"Primary care case management" or "PCCM" means the same in these rules as defined at 42 C.F.R. § 438.2.

"Primary care case management entity" or "PCCM entity" means the same in these rules as defined at 42 C.F.R. § 438.2.

"Prior authorization (~~PA~~)" or "PA" means a requirement that a member, through a provider, obtain the ~~managed care entity's~~CE or DBM approval before a requested medical service is provided or before services by a non-participating provider are received. Prior authorization is not a guarantee of claims payment; however, failure to obtain prior authorization may result in denial of the claim or reduction in payment of the claim. For purposes of these rules, "prior authorization" is included as a determination of health care services within the term "adverse benefit determination".

"Provider" means a health care or dental provider licensed or certified in this state.

317:2-3-2. Timeframes

(a) For the purpose of calculating a timeframe in this Subchapter, the date on the written notice is not included. The last day of the timeframe is included, unless the last day is a legal holiday, as defined by 25 ~~Oklahoma Statutes (O.S.)~~O.S. § 82.1, or any other day OHCA is closed or closes early, in which case, the timeframe runs until the close of the next full business day.

(b) A grievance or appeal a member sends via mail is deemed filed on the date the ~~MCE~~CE receives request.

(c) A request for reconsideration or appeal a provider sends via mail is deemed filed on the date the ~~MCE~~CE receives the request.

(d) A request for ~~State~~state fair hearing by a member or provider is deemed filed on the date the

OHCA receives the request.

317:2-3-3. Grievance and appeals system

In accordance with state and federal law, including but not limited to 63 ~~Oklahoma Statutes (O.S.)~~O.S. § 7310 and 42 ~~Code of Federal Regulations (C.F.R.)~~C.F.R. §§ 438.210, 431.213-14, 438.402, 438.404, 438.408, and 438.410, each ~~MCECE and DBM~~ will have an established grievance and appeals system by which to receive, process, and resolve grievances and appeals, including requests for extensions of relevant timeframes, and by which to afford parties proper notice.

317:2-3-4. Member grievances

(a) Filing.

(1) **Filing with ~~managed care entity~~ a CE or DBM.** Except as described in this ~~section~~Section, when the member is enrolled in a managed care program, the member initially files a grievance with the ~~managed care entity~~CE or DBM in which the member is enrolled.

(2) **Exception: Filing with OHCA.** When the member is enrolled in a ~~managed care~~SoonerSelect program and the grievance deals with direct interaction with OHCA or its employees or officers, the member first files the grievance with OHCA as an administrative appeal pursuant to applicable rules set forth at ~~Oklahoma Administrative Code (OAC)~~OAC 317:2-1-2 et seq.

(b) **Timing.** A member may file a grievance, orally or in writing, at any time.

(c) **Provider's and authorized representative's right to file a grievance.** A provider or an authorized representative may file a grievance on behalf of a member, provided that the provider or authorized representative has obtained the member's written consent to do so. The authorized representative of a deceased member's estate may also be a party to the ~~litigation~~resolution of a grievance, as applicable.

(d) **Clinical expertise in a grievance decision.** When a grievance involves clinical issues or is related to a denial of an expedited resolution of an appeal, the decision maker(s) of such a grievance will have clinical expertise as discussed at OAC 317:2-3-6.

(e) **Consideration of information in an appeal decision.** The decision maker(s) for any appeal will take into account all comments, documents, records, and other information submitted without regard to whether such information was submitted or considered in the initial determination.

(f) **OHCA-established timeframes for grievance decisions.** A grievance related in any way to the member's health condition will be resolved, with notice provided, as expeditiously as the member's health condition requires.

(1) Per 42 ~~Code of Federal Regulations (C.F.R.)~~C.F.R. § 438.408, the standard resolution of a grievance will occur within ninety (90) calendar days after the ~~managed care entity~~CE or DBM receives the grievance. The OHCA may choose to adopt a shorter timeframe for the grievance resolution. The CE and DBM must adhere to such timeframes that are described within the Contract.

~~(2) OHCA sets the standard resolution of a grievance to occur within sixty (60) calendar days, inclusive of any extensions, after the MCE receives the grievance.~~

~~(3)~~(2) The ~~MCECE and DBM~~ may extend the timeframe in ~~(f)(2)~~ up to fourteen (14) days if:

(A) The member requests the extension; or

(B) The ~~MCECE and DBM~~ shows (to the OHCA's satisfaction upon OHCA's request) that there is need for additional information and how the delay is in the member's interest.

~~(4)~~(3) If the ~~MCECE and DBM~~ extends the timeframes not at the request of the member, it must complete all of the following:

(A) Make reasonable efforts to give the member prompt oral notice of the delay; and

- (B) Within two (2) calendar days give the member written notice of the reason for the decision to extend the timeframe and inform ~~the enrollee~~Enrollee of the right to file a grievance if he or she disagrees with that decision; and
- ~~(5)~~(4) ~~The MCECE and DBM~~ will adhere to all OHCA rules related to grievances, including but not limited to:
- (A) Observing the timeframe for standard resolution of a grievance;
 - (B) Sending acknowledgement of receiving the grievance in writing to the member or the member's authorized representative within ten (10) calendar days of receipt; and
 - (C) Sending written notice conforming with this ~~subchapter~~Subchapter to the affected parties within three (3) calendar days following resolution of the grievance.

317:2-3-5. Member appeals

(a) Filing.

(1) **Filing with ~~managed care entity~~CE or DBM.** Except as described in this Section, when the member is enrolled in a managed care program, the member initially files an appeal with the ~~managed care entity~~CE or DBM in which the member is enrolled.

(2) **Exception: Filing with OHCA.** When the member is enrolled in a ~~managed care~~SoonerSelect program, the member initially files administrative appeals with OHCA and follows the appeals rules set forth at ~~Oklahoma Administrative Code (OAC)~~OAC 317:2-1-2 et seq. whenever the appeal concerns a decision the ~~Oklahoma Health Care Authority (OHCA)~~OHCA made regarding:

- (A) Eligibility for Oklahoma Medicaid;
- (B) Eligibility for a ~~managed care~~SoonerSelect program;
- (C) Enrollment into Oklahoma Medicaid;
- (D) Enrollment, including use of an auto-assignment algorithm, into a ~~managed care entity~~CE or DBM;
- (E) Disenrollment from a ~~managed care entity~~CE or DBM; or
- (F) Any other matter, so long as OHCA made the decision in the matter.

(b) **Timing.** ~~A member may file an appeal, orally or in writing, at any time. An administrative appeal or State fair hearing request made to OHCA shall conform with the requirements of OAC 317:2-1-2 et seq. in terms of the manner and timing of any such filing.~~

(1) Per OAC 317:2-3-4(b), a member may file a grievance at any time. If the grievance decision is adverse to the member, the member may file an appeal. The member has sixty (60) days from the adverse decision notice to file an appeal.

(2) An administrative appeal or state-fair hearing request made to OHCA shall conform with the requirements of OAC 317:2-1-2 et seq. in terms of the manner and timing of any such filing.

(c) **Levels of appeals.** ~~The ~~managed care entity~~CE or DBM will use only one (1) level of ~~appeals~~appeal, in accordance with 42 ~~Code of Federal Regulations (C.F.R.)~~C.F.R. § 438.402.~~

(d) **Provider's and authorized representative's right to file an appeal.** A provider or an authorized representative may file an appeal on behalf of a member, provided that the provider or authorized representative has obtained the member's written consent to do so. The authorized representative of a deceased member's estate may also be a party to the litigation of an appeal, as applicable.

(e) **Clinical expertise in an appeal decision.** When an appeal involves clinical issues or is related to a denial based on lack of medical necessity, the decision maker(s) of such an appeal will have clinical expertise as discussed at OAC 317:2-3-6.

(f) **Consideration of information in an appeal decision.** The decision maker(s) for any appeal will take into account all comments, documents, records, and other information submitted without regard

to whether such information was submitted or considered in the initial determination.

(g) **OHCA-established timeframes for appeals decisions.** An appeal related in any way to the member's health condition will be resolved, with notice provided, as expeditiously as the member's health condition requires.

~~(1) Per 42 C.F.R. § 438.408, the standard resolution of an appeal will occur within thirty (30) calendar days after the managed care entity receives the appeal.~~

~~(2)~~(1) Per 42 C.F.R. § 438.408, the OHCA establishes the following timeframes for appeals:

(A) Standard resolution of an appeal will occur within thirty (30) calendar days, excluding any extensions, after the ~~managed care entity~~CE or DBM receives the appeal;

(B) ~~Expedited resolution of an appeal will occur within seventy two (72) clock hours after the MCECE receives the appeal;~~The CE and DBM will be responsible for expedited resolutions.

(i) An expedited appeal resolution should occur if the standard resolution timeframe could jeopardize the Enrollee's life or health or ability to attain, maintain, or regain maximum function.

(ii) Per 42 C.F.R. § 438.408(b)(2), if the CE or DBM denies a request for expedited appeal resolution, the CE or DBM must transfer the appeal to the standard appeal resolution timeframe.

(C) In exigent circumstances, resolution of a step therapy request appeal will occur within twenty-four (24) clock-hours after the ~~MCECE~~CE receives the appeal; and

(D) In all other circumstances, resolution of a step therapy request appeal will occur within seventy-two (72) clock-hours after the ~~MCECE~~CE receives the appeal.

~~(3)~~(2) The ~~MCECE~~CE and ~~DBM~~DBM may extend the timeframes in (g)(2)(1)(A) or (B) up to fourteen (14) days if:

(A) The member requests the extension; or

(B) The ~~MCECE~~CE and ~~DBM~~DBM shows (to the OHCA's satisfaction upon OHCA's request) that there is need for additional information and how the delay is in the member's interest.

(4)(3) If the ~~MCECE~~CE and ~~DBM~~DBM extends the timeframes not at the request of the member, it must complete all of the following:

(A) Make reasonable efforts to give the member prompt oral notice of the delay;

(B) Within two (2) calendar days give the member written notice of the reason for the decision to extend the timeframe and inform ~~the enrollee~~Enrollee of the right to file a grievance if he or she disagrees with that decision; and

(C) Resolve the appeal as expeditiously as the member's health condition requires and no later than the date the extension expires.

~~(5)~~(4) The ~~MCECE~~CE and ~~DBM~~DBM will adhere to all OHCA policies related to appeals, including but not limited to:

(A) Observing the timeframes for resolving appeals, including standard resolution, expedited resolution, and resolution of step therapy appeals (in both exigent and other circumstances);

(B) Sending acknowledgement of receiving the appeal in writing to the member or the member's authorized representative within five (5) calendar days of receipt;

(C) Sending written notice conforming with this ~~subchapter~~Subchapter to the affected parties within three (3) calendar days following resolution of the appeal; and

(D) Sending documentation, in conformance with OAC 317:2-3-12(d) and any established OHCA forms or processes, to OHCA within fifteen (15) calendar days after a request for ~~State~~state fair hearing.

317:2-3-5.1. Continuation of benefits pending appeal and state fair hearing

(a) Per OAC 317:2-1-2.6 and 42 C.F.R. § 438.420, the CE or DBM shall continue a member's benefits under the plan when all of the following occur:

(1) The member files the request for an appeal within sixty (60) calendar days following the date on the adverse benefit determination notice in accordance with 42 C.F.R. § 438.402(c)(1)(ii) and (c)(2)(ii):

(2) The appeal involves the termination, suspension, or reduction of previously authorized services;

(3) The services were ordered by an authorized provider;

(4) The period covered by the original authorization has not expired; and

(5) The member timely files for continuation of benefits, meaning on or before the later of the following:

(A) Within ten (10) calendar days of the CE or DBM sending the notice of adverse benefit determination; or

(B) The intended effective date of the CE or DBM's proposed adverse benefit determination.

(b) If the member fails to indicate a preference as to continuation or reinstatement of services in a written request for hearing made within sixty (60) calendar days of the adverse benefit determination, services shall be continued or reinstated. Notwithstanding the foregoing, continuation or reinstatement of benefits shall not occur under the following circumstances:

(1) The member has exceeded the limit applicable to the services; or

(2) When a provider has failed to prescribe or order the service or level of service for which continuation or reinstatement is requested.

(c) The CE or DBM shall continue or reinstate benefits if the member:

(1) Files a request for a state fair hearing within one hundred twenty (120) days of the adverse resolution notice; and

(2) Files a request for continuation of benefits within thirty (30) calendar days of the adverse resolution notice.

(d) If the CE or DBM continues or reinstates the member's benefits at the member's request while the appeal or state fair hearing is pending, the benefits must be continued until one (1) of the following occurs:

(1) The member withdraws the appeal or request for state fair hearing;

(2) The member fails to request a state fair hearing and continuation of benefits within ten (10) calendar days after the CE or DBM sends the notice of an adverse resolution to the member's appeal under 42 C.F.R. §§ 438.420 (c)(2) and 438.408 (d)(2); or

(3) A state fair hearing officer issues a hearing decision adverse to the member.

317:2-3-6. External medical review and clinical expertise

(a) ~~No external~~**External** medical review. The ~~Oklahoma Health Care Authority (OHCA)~~**OHCA** will not offer an external medical review for the purposes of grievances or appeals.

(b) **Clinical expertise standards.** Individuals making the decision for a grievance or appeal regarding an adverse benefit determination will be unbiased with appropriate clinical expertise in treating the member's condition or disease.

(1) Medical review staff of the ~~MCE~~**CE** and **DBM** will be licensed or credentialed health care clinicians with relevant clinical training and/or experience.

(2) All **CE** and **DBM** will use medical review staff for such appeals and shall not use any automated claim review software or other automated functionality for such appeals.

(3) Bias is deemed to exist if an individual making a decision on a grievance or appeal was

involved in, or a subordinate of any individual involved in, any previous level of review or decision regarding the subject matter of the grievance or appeal.

(4) Clinical expertise is deemed necessary for decisions makers whenever:

- (A) The denial is based on a lack of medical necessity;
- (B) The grievance is regarding a denial of an expedited resolution an appeal; and
- (C) The grievance or appeal involves clinical issues.

317:2-3-7. Obligation to pay costs of services

~~(a) In accordance with 42 Code of Federal Regulations (C.F.R.) § 438.420(d), the MCE may recover from the member the costs of services provided to the member while an appeal or State fair hearing is pending:~~

~~(1) To the extent the services were continued solely due to the requirements set forth in 42 C.F.R. §§ 438.420 or 431.230(b); and~~

~~(2) The final resolution of the appeal or Statestate fair hearing upholds the adverse benefit determination.~~

~~(b)(a)~~ If OHCA or the MCECE and DBM reverses a decision to deny, limit, or delay services and these services were not furnished while the appeal or Statestate fair hearing was pending, the MCECE and DBM will authorize or provide the disputed services promptly and as expeditiously as the member's health condition requires.

~~(e)(b)~~ If OHCA or the MCECE and DBM reverses a decision to deny, limit, or delay services and the member received the disputed services while the appeal or Statestate fair hearing was pending, the MCECE and DBM will pay for these services.

317:2-3-8. Grievances and appeals notice

(a) The MCECE and DBM will provide timely written notices per OAC 317:2-3-4 and 317:2-3-5.

(b) Each notice will conform to the provisions of 42 ~~Code of Federal Regulations (C.F.R.)~~C.F.R. § 438.10 related to information provided from an MCECE and DBM to a member.

(c) At minimum, each notice will:

(1) Be written in a manner and format, as outlined in the Contract, that may be easily understood and is readily accessible by members;

(2) Use OHCA-developed definitions for terms as those terms are defined in the ~~Model Member~~Enrollee Handbook related to the ~~contract~~Contract;

(3) Use a font size no smaller than twelve-point (12-point);

(4) Be made available in alternative formats and through the provision of auxiliary aids and services in an appropriate manner that takes into consideration the special needs of members with disabilities or limited English proficiency; and

(5) Include a large-print tagline, in minimum eighteen-point (18-point) font, and information on how to request auxiliary aids and services, including the provision of materials in alternative formats.

(d) Per the delegation choice of 42 C.F.R. § 438.228, OHCA does not delegate responsibility to the MCECE and DBM for timely notices of action under 42 C.F.R. Part 431, Subpart E.

(1) OHCA retains all responsibility for timely notices of action under 42 C.F.R. Part 431, Subpart E, including:

(A) A termination, suspension of, or reduction in covered benefits or services, when termination, suspension, or reduction is determined by OHCA;

(B) A termination, suspension of, or reduction in Medicaid eligibility, when termination, suspension, or reduction is determined by OHCA; and

(C) An increase in beneficiary liability, including determination that a beneficiary will

incur a greater amount of medical expenses in order to establish income eligibility or is subject to an increase in premiums or cost sharing charges, when such increase is determined by OHCA.

(2) The foregoing (d)(1) does not apply to:

(A) Any grievance notice required to be sent by the MCECE and DBM by ~~contract~~Contract or 42 C.F.R. § 438.408;

(B) Any adverse benefit determination notice based on the termination, suspension, or reduction of authorized covered services, payment denial, or standard, expedited, or untimely service authorization denial or limitation as required to be sent by the MCECE and DBM by contract or 42 C.F.R. § 438.404;

(C) Any appeal resolution notice required to be sent by the MCECE and DBM by contract or 42 C.F.R. § 438.404 or 438.408; or

(D) Any other notice required to be sent by the MCECE and DBM by ~~contract~~Contract or any state or federal law or regulation.

(3) OHCA's decision not to delegate the notices of action required by 42 C.F.R. Part 431 Subpart E applies to any ~~managed care entity~~CE or DBM under any ~~managed care contract~~Contract for professional services unless and until this ~~section~~Section is revoked.

(4) The random review system required of a state by 42 C.F.R. § 438.228 does not apply to OHCA, because OHCA has not delegated responsibility for the relevant notices of action.

(5) For any notices of action for which OHCA retains responsibility under this ~~section~~Section, OHCA will ensure the notice conforms to federal regulations at 42 C.F.R. Part 431, Subpart E, and any applicable requirements under 42 C.F.R. § 438.228. OHCA will send such notices of action by electronic or postal means at least ten (10) days before the date of action, except as permitted when:

(A) OHCA has factual information confirming the death of a beneficiary;

(B) OHCA receives a clear written statement signed by a member that they no longer wish to receive services or that gives information that requires termination or reduction of services and indicates that the member understands that supplying the information will result in termination or reduction of services;

(C) The member has been admitted to an institution where they are ineligible for further services;

(D) The member's whereabouts are unknown and the post office returns, indicating no forwarding address, OHCA mail sent directly to the member; ~~and/or~~

(E) The MCECE and DBM establishes the fact that the member has been accepted for Medicaid services by another local jurisdiction, state, territory, or commonwealth.

(6) For any notices of action for which OHCA retains responsibility under this Section, OHCA will ensure the notice contains:

(A) A statement of the action OHCA intends to take and the effective date of such action;

(B) A clear statement of the specific reasons supporting the intended action, the specific regulations that support or require the action, and an explanation of the member's rights to request a hearing; and

(C) An explanation of the circumstances under which benefits continue if a hearing is requested.

(7) For any notices of action for which OHCA retains responsibility under this ~~section~~Section, OHCA will allow the member a reasonable time, not to exceed ninety (90) days from the date the notice is mailed, to request a ~~State~~state fair hearing.

317:2-3-9. Exhaustion of ~~managed care entity~~CE or DBM appeals

(a) **Deemed exhaustion of MCE or DBM appeals.** If the MCECE and DBM fails to adhere to any timing or notice requirements as detailed in 42 C.F.R. § 438.408, the member is deemed to have exhausted the MCE's CE's or DBM's appeal process, and the member or the member's authorized representative may request a Statestate fair hearing.

(b) **Actual exhaustion of MCECE or DBM appeals.** Except as allowed in (a), a member or the member's authorized representative may request a Statestate fair hearing only after receiving notice from the MCECE and DBM upholding an adverse benefit determination and only within one hundred twenty (120) days after the date of the notice of appeal resolution.

(c) **Exhaustion of MCECE or DBM appeals, determination.** OHCA has sole authority to decide whether MCECE and DBM appeals have been exhausted for any member. Documentation, as submitted to OHCA by the MCECE and DBM within fifteen (15) calendar days of the request for Statestate fair hearing, will serve as evidence to deemed exhaustion, actual exhaustion, or no exhaustion of the MCECE and DBM appeals process.

317:2-3-10. Provider complaint system and appeal requests

(a) A participating provider or nonparticipating provider may file a complaint whenever:

- (1) The provider is not satisfied with the MCE's CE's or DBM's policies and procedures; or
- (2) The provider is not satisfied with a decision made by the MCECE and DBM that does not impact the provision of services to members.

(b) The MCECE and DBM will establish and operate a provider complaint system. Such system will:

- (1) Use written policies and procedures for receiving, tracking, dating, storing, responding to, reviewing, reporting, and resolving provider complaints;
- (2) Track receipt and resolution of provider complaints, including requests for reconsideration or appeals;
- (3) Demonstrate sufficient ability to receive provider complaints by telephone, in writing, or in person;
- (4) Designate staff to receive, process, and resolve provider complaints;
- (5) Thoroughly investigate each provider complaint;
- (6) Ensure an escalation process for provider complaints;
- (7) Furnish the provider timely written notification of resolution or results; and
- (8) Maintain a tracking system capable of generating reports to OHCA on provider complaint volume and resolution.

(c) The MCECE and DBM will operate a reconsideration process whereby providers may request the MCECE and DBM reconsider a decision the MCECE and DBM has made or intends to make that is adverse to the provider, including, at minimum, reconsiderations of provider audit findings, reconsiderations of provider agreement termination, and reconsiderations of denied claims.

(1) **Request for reconsideration, denied claims.** The MCECE and DBM will ask that the provider submits a request for reconsideration of a denied claim within six (6) months after the provider receives notice of the denied claim.

(2) **Request for reconsideration, all other reasons.** The MCECE and DBM will ask that the provider submits a request for reconsideration within fifteen (15) days after the date the provider receives notice of audit findings, termination of provider agreement, or other actions the MCECE and DBM permits for reconsideration requests.

(3) **Desk review.** The MCECE and DBM will conduct the reconsideration through a desk review of the request and all related and available documents.

(4) **Reconsideration resolution.** The MCECE and DBM will resolve all requests for reconsideration within ~~twenty (20) calendar days of the date the MCE receives the request for~~

~~reconsideration~~the timeframes established by the OHCA. The MCECE and DBM will send a reconsideration resolution notice to the provider within ~~three (3) days of the MCE finalizing the resolution~~ five (5) calendar days of resolution of the consideration.

(5) **Notice of ~~Reconsideration Resolution~~ reconsideration resolution.** The MCECE and DBM will send a reconsideration resolution notice that contains, at a minimum:

- (A) The date of the notice;
- (B) The action the MCECE has made or intends to make;
- (C) The reasons for the action;
- (D) The date the action was made or will be made;
- (E) The citation to statute, regulation, policy, or procedure, if any, upon which the action was based;
- (F) An explanation of the provider's ability to submit an appeal request to the MCECE and DBM within thirty (30) calendar days of the date recorded on the notice;
- (G) The address and contact information for submitting an appeal;
- (H) The procedures by which the provider may request an appeal regarding the MCE'sCE's or DBM's action;
- (I) The specific change in federal or state law, if any, that requires the action;
- (J) The provider's ability to submit a Statestate fair hearing request following completion of the provider appeal process, or, in cases of an action based on a change in law, the circumstances under which a Statestate fair hearing will be granted; and
- (K) Any other information required by state or federal statute or regulation, by contract, or by contract-related manual.

(d) The MCECE and DBM will operate an appeals process whereby a provider may request an appeal of a reconsideration resolution when the underlying matter is based on the MCE'sCE or DBM's provider audit findings; or for-cause or immediate termination of the provider agreement; ~~or a denied claim.~~

(1) **Request for appeal.** The MCECE and DBM will require the provider to submit a request for appeal in writing within thirty (30) calendar days after the provider receives notice reconsideration resolution.

(2) **Panel review.** The MCECE and DBM will conduct the appeal through a panel review including a hearing and review of the request, all related and available documents, and all documents created for or used in connection with the request for reconsideration.

(A) The panel will consist of three (3) or five (5) reviewers, who are employees or officers of the MCECE and DBM.

(B) Panel members will not have been directly involved with the reconsideration desk review and will not be a subordinate of someone involved directly with the reconsideration desk review.

(C) The panel review hearing will provide the provider or an authorized representative of the provider with a reasonable opportunity to be heard in person or by telecommunications.

(D) The review panel will accept and document any exhibit offered prior to the hearing or during the hearing, so long as the exhibit directly relates to the matter of the appeal.

(E) When the appeal is based on a claim denied on the basis of medical necessity, the following requirements apply:

(i) Medical or dental review staff of the MCECE and DBM will be licensed or credentialed health care clinicians with relevant clinical training or experience; and

(ii) All MCEsCEs or DBMs will use medical or dental review staff for such appeals and will not use any automated claim review software or other automated functionality for such appeals.

(3) **Appeal resolution.** The MCECE and DBM will resolve all appeals within ~~forty-five (45)~~ calendar days of the date the MCE receives the request for appeal the timeframes established by the OHCA. The MCECE and DBM will send an appeal resolution notice to the provider within ~~three (3) business~~ five (5) calendar days of the MCECE and DBM finalizing the resolution.

(4) **Notice of ~~Appeal Resolution~~ appeal resolution.** The MCECE and DBM will send an appeal resolution notice that contains, at a minimum:

(A) The date of the notice;

(B) The date of the appeal resolution; and

(C) For decisions not wholly in the provider's favor:

~~(i) An explanation of the provider's ability to request a State fair hearing within thirty (30) calendar days of the date recorded on the notice;~~

~~(ii) How to request a State fair hearing, including the OHCA address and contact information for submitting a request;~~

~~(iii) Details on the right to be represented by counsel at the State fair hearing; and~~

~~(iv) Any other information required by state or federal statute or regulation, by contract, or by contract-related manual.~~

(i) An explanation of the provider's ability to request and OHCA administrative appeal within thirty (30) calendar days of the date recorded on the notice;

(ii) How to request an OHCA administrative appeal, including the OHCA address and contact information for submitting a request;

(iii) Details on the right to be represented by counsel at the OHCA administrative appeal.

(D) Any other information required by state or federal statute or regulation, by Contract, or by Contract-related manual.

(5) **Documentation.** The MCECE and DBM will furnish to OHCA documentation including all information specified at ~~OAC 317:2-3-13(e)(2)~~ within the Contract within fifteen (15) calendar days of a provider's request for a ~~State fair hearing~~ an OHCA administrative appeal.

(6) **State fair hearing for providers.** There are no state fair hearings provided for providers under a CE or DBM, per OAC 317:2-3-13.

317:2-3-11. Recordkeeping

In compliance with 42 C.F.R. § 438.3(h) and (u), the MCE or DBM will maintain records of each grievance and appeal for ten (10) years after the later of the final date of the contract period or the date of completion of any MCE or DBM audit by the State, the Centers for Medicare and Medicaid Services (CMS), the Office of the Inspector General, or the Comptroller General. Such records will be part of OHCA's ongoing monitoring and will be used to update and revise OHCA's ~~managed care~~ SoonerSelect quality strategy. The record will conform with the content requirements at 42 C.F.R. § 438.416.

317:2-3-12. State fair hearing for members

(a) **Right to state fair hearing.** With regard to grievances or appeals first filed with the MCECE and DBM, a member may request a State fair hearing under 42 C.F.R. 431 Subpart E only after receiving notice from the MCECE and DBM upholding an adverse benefit determination. The member will have one-hundred twenty (120) days from the date of the adverse benefit determination notice to request a State fair hearing. Refer to 42 C.F.R. §§ 438.402(c)(1)(i) and 438.408(f)(1).

(b) **MCECE or DBM policies and procedures.** The MCECE and DBM will implement established policies and procedures that allow a member described in (a) to initiate a State fair hearing

process after having exhausted the MCE's CE or DBM's appeals process or after the member is deemed to have exhausted the process due to the MCE's CE or DBM's failure to adhere to notice and timing requirements.

(c) **Member's request for a Statestate fair hearing.** The MCECE and DBM will allow the member to request a Statestate fair hearing either through an established MCECE and DBM process or through an established OHCA process. Any MCECE and DBM process will ensure that notice of the request for Statestate fair hearing is communicated in writing to the OHCA contracting officer within twenty-four (24) clock-hours of receiving the request.

(d) **MCECE or DBM documentation obligation.** The MCECE and DBM will provide documentation to the member, the member's authorized representative, OHCA, and the Office of Administrative Hearings.

(1) **Timing.** The MCECE and DBM will provide the ~~documentation~~ support documentation (summary) described in this subsection: within fifteen (15) calendar days after notification of the request for state fair hearing.

~~(A) Within twenty-four (24) clock-hours after receiving notification of the request for State fair hearing relating to a step therapy request; or~~

~~(B) Within fifteen (15) calendar days after notification of the request for State fair hearing in all other circumstances.~~

(2) **Information.** ~~Documentation~~ Support documentation (summary) will include, at minimum, the following information:

(A) The name and address of the member and, if applicable, the member's authorized representative;

(B) A summary statement concerning why the member has filed a request for Statestate fair hearing;

(C) A brief chronological summary of the MCE's CE or DBM's action in relationship to the matter underlying the member's request for Statestate fair hearing;

(D) The member's appeal request, along with any supporting documentation, if received by the MCECE and DBM;

(E) Any applicable correspondence between the MCECE and DBM and the member, including system notes entered by one (1) or more MCECE and DBM employees based on one (1) or more telephone conversations with the member;

(F) All exhibits offered at any hearing held with the MCECE and DBM;

(G) All documents the MCECE and DBM used to reach its decision;

(H) A statement of the legal basis for the MCE's CE or DBM's decision;

(I) A citation of the applicable policies and/or legal authorities relied upon by the MCECE or DBM in making its decision;

(J) A copy of the notice which notified the member of the decision in question;

(K) The names and titles of any MCECE or DBM employees who will serve as witnesses at the Statestate fair hearing; and

(L) Any other information requested by the member, the member's authorized representative, OHCA, or the Office of Administrative Hearings when the information relates to the Statestate fair hearing or any matter giving rise to the Statestate fair hearing.

(e) **MCECE or DBM staffing.** The MCECE or DBM will maintain a sufficient level of staffing to competently perform the functions, requirements, roles, and duties involved in Statestate fair hearing support, including but not limited to documentation, summarization of the arguments presented, and ensuring timely notice and delivery of documents to all parties.

(f) **Performance targets.** OHCA may set performance targets related to Statestate fair hearing

requests that are resolved upholding the MCE's CE or DBM's original determination when and as OHCA deems necessary or appropriate.

(g) **Post-transition obligations.** After termination or expiration of the ~~managed-care contract~~Contract, the MCE CE or DBM will remain responsible for State fair hearings related to dates of service prior to the ~~contract~~Contract termination or expiration, including but not limited to the provision of records and representation at State fair hearings.

(h) **Cost of services.** If the State fair hearing officer reverses the MCE's CE or DBM's decision to deny authorization of services and the member received the disputed services while the State fair hearing was pending, the MCE CE or DBM will pay for those disputed services.

317:2-3-13. State fair hearing for providers

~~(a) **Right to State fair hearing.** With regard to provider audit findings, for cause and immediate termination of the provider's agreement, and claims denial, a provider may request a State fair hearing within thirty (30) calendar days of the MCE's notice of appeal resolution when that resolution does not favor the provider.~~

~~(b) **Information for providers.** As a part of the MCE's provider complaint system, the MCE will provide information to providers on how to request a State fair hearing via filing the appropriate form with the OHCA Docket Clerk.~~

~~(c) **MCE documentation obligation.** The MCE will provide documentation to the provider, OHCA, and the Office of Administrative Hearings.~~

~~(1) **Timing.** The MCE will provide the documentation described in this subsection within fifteen (15) calendar days after notification of the request for State fair hearing.~~

~~(2) **Information.** Documentation will include, at minimum, the following information:~~

~~(A) The name and address of the provider;~~

~~(B) A summary statement concerning why the provider has filed a request for State fair hearing;~~

~~(C) A brief chronological summary of the MCE's action in relationship to the matter underlying the provider's request for State fair hearing;~~

~~(D) The provider's appeal request, along with any supporting documentation, if received by the MCE;~~

~~(E) Any applicable correspondence between the MCE and the provider, including system notes entered by one or more MCE employees based on one or more telephone conversations with the provider;~~

~~(F) All exhibits offered at any hearing held with the MCE;~~

~~(G) All documents the MCE used to reach its decision;~~

~~(H) A statement of the legal basis for the MCE's decision;~~

~~(I) A citation of the applicable policies and/or legal authorities relied upon by the MCE in making its decision;~~

~~(J) A copy of the notice which notified the provider of the decision in question;~~

~~(K) The names and titles of any MCE employees who will serve as witnesses at the State fair hearing; and~~

~~(L) Any other information requested by the provider, OHCA, or the Office of Administrative Hearings when the information relates to the State fair hearing or any matter giving rise to the State fair hearing.~~

(a) There are no state fair hearings provided for providers under a CE or DBM. The CE or DBM shall provide the following:

(1) A provider complaint system;

(2) A provider reconsideration system whereby providers may request the CE or DBM to reconsider the decision the CE or DBM has made or intends to make that is adverse to the provider. This shall include, at minimum, reconsiderations for Program Integrity provider audit findings and provider agreement termination.

(3) Provider appeal to the CE or DBM:

(A) The CE or DBM shall implement and operate a system for provider appeals of the CE or DBM's audit findings related to Program Integrity efforts and for cause and immediate provider agreement termination.

(B) The CE or DBM shall operate a process whereby providers may appeal a decision the CE or DBM has made or intends to make that is adverse to the provider.

(b) For decisions not wholly in the provider's favor an OHCA administrative appeal will be provided, per OAC 317:2-3-10 (d)(4)(C).

317:2-3-14. Administrative Law Judge (ALJ) jurisdiction

The ALJ has jurisdiction of the following matters:

(1) **Member ~~State~~ fair hearing.** The ALJ has jurisdiction to hear any ~~State~~ fair hearing arising from a member's ~~MCE~~ or ~~DBM~~ appeal of an adverse benefit determination.

(2) **~~Provider State fair hearing.~~** ~~The ALJ has jurisdiction to hear any State fair hearing arising from a provider's appeal of audit findings, for cause or immediate termination of the provider's contract with the MCE, or claims denial.~~ **Provider OHCA administrative appeal.** The ALJ has jurisdiction to hear any OHCA administrative appeal arising from a decision that was not wholly in the provider's favor.

This page intentionally left blank

**TITLE 317. OKLAHOMA HEALTH CARE AUTHORITY
CHAPTER 55. MANAGED CARE**

SUBCHAPTER 1. GENERAL PROVISIONS

317:55-1-1. Purpose; use of manuals

The purpose of this Chapter is to provide detailed rules which govern the delivery of health care services provided by ~~managed care organizations~~ contracted entities or dental benefits managers as required by the "Ensuring Access to Medicaid Act", 2021 Okla. Sess. Law Serv. Ch. 542 (S.B. 131), Title 56 of the Oklahoma Statutes, Sections 4002-4004 and 42 Code of Federal Regulations (C.F.R.), Part 438. The Oklahoma Health Care Authority may also develop manuals and medical guidelines that formalize terms, conditions, and applicable policy of awarded contracts.

317:55-1-2. Monitoring system for all managed care programs [REVOKED]

~~In accordance with 42 C.F.R. § 438.66, the Oklahoma Health Care Authority will monitor each managed care organization or dental benefits manager to assess its ability and capacity to comply with program and contract specific requirements and to assess its ability to perform satisfactorily in all major operational areas.~~

317:55-1-3. Definitions

The following words and terms, when used in this Chapter, will have the following meaning, unless the context clearly indicates otherwise:

~~"1115 waiver" means the demonstration waiver, as amended and including all active special terms and conditions (STCs) at a specific point in time, that authorizes Oklahoma Health Care Authority (OHCA) to operate a program in which one or more requirements of Title XIX of the Social Security Act (Act) are waived based on the waiver authority of section 1115 of the Act.~~

~~"1915(c) waiver" means any waiver, authorized by section 1915(c) of the Act, that allows specific coverage of home and community based services to a limited group of Medicaid eligible individuals as an alternative to institutional care.~~

~~"Accountable care organization" or "ACO" means a group of clinicians, hospitals, or other health care providers who come together voluntarily to give coordinated high quality care to a designated group of patients.~~

~~"Act" means the Social Security Act.~~

~~"Adult" means an individual twenty one (21) years of age or older, unless otherwise specified by statute, regulation, and/or policy adopted by the OHCA. For eligibility criteria policy for children and adults, please refer to Oklahoma Administrative Code (OAC) 317:35-5-2.~~

~~"Adverse determination" means a determination by a health carrier, including an managed care organization (MCO) or dental benefits manager (DBM), or its designee that an admission, availability of care, continued stay or other health care service that is a covered benefit has been reviewed and, based upon the information provided, does not meet the health carrier's requirements for medical necessity, appropriateness, health care setting, level of care or effectiveness, and the requested service or payment for services is therefore denied, reduced or terminated.~~

~~"Alternative benefit plan" means the benefit package delivered to expansion adults which is developed by OHCA and approved by the Centers for Medicare and Medicaid Services (CMS) in accordance with the requirements of Subpart C of 42 C.F.R. Part 440.~~

~~"American Indian/Alaska Native" or "AI/AN" means any individual as defined in 25 U.S.C. §§ 1603(13), 1603(28) or 1679(a) or who has been determined eligible as an Indian under 42 C.F.R. § 136.12.~~

"Appeal" means a review by an MCO or DBM of an adverse benefit determination.

"Authorized representative" means a competent adult who has the managed care enrollee's signed, written authorization to act on the managed care enrollee's behalf during the grievance, appeal, and State fair hearing process. The written authority to act will specify any limits of the representation.

"Capitation payment" means a payment, based on an actuarially sound capitation rate for the provision of Oklahoma Medicaid State Plan services under a managed care contract, that OHCA makes periodically to the MCO or DBM behalf of each enrollee enrolled in that MCO or DBM, regardless of whether the enrollee actually receives services during the period covered by the payment.

"Capitation rate" means the actuarially sound per enrollee, per month amount, including any adjustments, that OHCA agrees to pay an MCO or DBM for the provision of State Plan services.

"Child" means an individual under twenty one (21) years of age, unless otherwise specified by statute, regulation, and/or policy adopted by the OHCA. For eligibility criteria policy for children and adults, please refer to OAC 317:35-5-2.

"Children's Health Insurance Program" or "CHIP" means a federal Medicaid program authorized under Title XXI of the Social Security Act.

"Choice counseling" means the provision of information and services designed to assist eligibles in making enrollment decisions related to the managed care program. Choice counseling includes answering questions and identifying factors to consider when choosing among MCOs or DBMs, as well as when choosing a patient centered medical home provider or dental home provider. Choice counseling does not include making recommendations for or against enrollment into a specific MCO or DBM.

"Chronic condition" means a condition that is expected to last one (1) year or more and requires ongoing medical attention and/or limits activities of daily living (ADL).

"Civil monetary damage" means a damage imposed by OHCA which the MCO must pay for acting or failing to act in accordance with 42 C.F.R. § 438.700 et seq. Amounts may not exceed those specified in 42 C.F.R. § 438.704.

"Claims denial error rate" means the rate of claims denials that are overturned on appeal.

"Clean claim" means a properly completed billing form with coding based on Current Procedural Terminology (CPT), 4th Edition or a more recent edition, the Tenth Revision of the International Classification of Diseases or a more recent revision, or Healthcare Common Procedure Coding System (HCPCS), where applicable, to provide information specifically required in the OHCA Provider Billing and Procedure Manual.

"C.F.R." means the Code of Federal Regulations.

"Contract" means the risk contract or the written and executed agreement between OHCA and a health plan or managed care organization or dental benefit manager for health plan or managed care services and includes the solicitation, the bid, the contract addenda, appendices, attachments, and amendments, and any documents incorporated into the contract by reference or otherwise, as well as any document or information subject to the rules on legally binding procurement in Chapter 10 of these rules.

"Copayment" means a fixed amount that an enrollee pays for a covered health care service when the enrollee receives the service.

"Cost sharing" means the State's requirement that an enrollee bear some of the cost of their care through mechanisms such as copayments, deductibles, and other similar charges.

"Deemed newborn" means children born to SoonerCare enrolled mothers and determined eligible under 42 C.F.R. § 435.117.

"Dental benefits manager" or "DBM" means a health plan under contract with the OHCA to

manage and deliver dental benefits and services to enrollees and designated as a pre-paid ambulatory health plan (PAHP) under 42 C.F.R. Part 438.

"Dental home" or **"DH"** means the care coordinated delivery system as defined within the contract between OHCA and a DBM.

"Disenrollment" means OHCA's removal of an enrollee from participation in a specific MCO or DBM or from participation in the managed care program.

"Dual eligible individuals" means individuals eligible for both Medicaid and Medicare.

"Eligible" means an individual who has been deemed eligible for Medicaid in the State of Oklahoma and is eligible for participation in the managed care program but who is not yet enrolled in an MCO or DBM.

"Emergency services" means medical services provided for a medical condition, including injury, manifesting itself by acute symptoms of sufficient severity, including severe pain, that a prudent layperson who possesses an average knowledge of health and medicine could reasonably expect the absence of immediate medical attention to result in placing the individual's health, or the health of an unborn child, in serious jeopardy, serious impairment to bodily functions or serious dysfunction of any bodily organs or parts.

"Enrollee" means an individual who has been deemed eligible for Medicaid in the State of Oklahoma, who has been deemed eligible for enrollment in a managed care program, and who is currently enrolled in a managed care program.

"Enrollee handbook" means a guidebook prepared as a model by OHCA and modified and distributed by the MCO or DBM to its enrollees. The enrollee handbook is designed to help the enrollee understand the MCO or DBM, the managed care program, and the rights and responsibilities that come with enrollment in the program.

"Enrollment" means the OHCA process by which an eligible becomes an enrollee with an MCO or DBM.

"Enrollment activities" means activities that OHCA performs or conducts related to distributing, collecting, or processing enrollment materials, taking enrollments by technological device or in person, or enrolling or disenrolling eligibles into any MCO or DBM.

"Essential community provider" means a provider defined by 45 C.F.R. § 156.235.

"Essential hospital services" means tertiary care hospital services to which the MCO must provide access, including but not limited to neonatal, perinatal, pediatric, trauma and burn services.

"Expansion adult" means an individual nineteen (19) or older and under age sixty-five (65), with income at or below one hundred thirty-eight percent (138%) of the federal poverty level (FPL) determined eligible in accordance with 42 C.F.R. § 435.119), and who are not categorically related to the aged, blind, and disabled.

"Former foster children" or **"FFC"** means individuals under age twenty-six (26) determined eligible in accordance with 42 C.F.R. § 435.150 who were in foster care under the responsibility of the State or an Indian Tribe within Oklahoma and enrolled in SoonerCare on the date of attaining age eighteen (18) or aging out of foster care.

"Foster children (FC)" means children in foster care under the responsibility of the State, including children and youth who are in State custody due to abuse or neglect.

"Fraud" means intentional deception or misrepresentation made by a person with the knowledge that the deception could result in some unauthorized benefit to himself or some other person. It includes any act that constitutes fraud under applicable federal or State law.

"Grievance" means an enrollee's expression of dissatisfaction about any matter other than an adverse benefit determination. Grievances may include, but are not limited to, the quality of care or services provided, aspects of interpersonal relationships such as rudeness of a provider or employee or failure to respect the enrollee's rights regardless of whether remedial action is requested. A

grievance includes an enrollee's right to dispute an extension of time to make an authorization decision when proposed by the MCO or DBM.

"Grievance and appeal system" means the processes the MCO or DBM must implement in accordance with 42 C.F.R. Part 438, Subpart F, to handle enrollee grievances and appeals, as well as the processes to collect and track information about them.

"Health care services" means all Medicaid State Plan services provided, according to contract, by the MCO or DBM in any setting. Health care services may include but are not limited to medical care, behavioral health care, dental care, and pharmacy services.

"Health plan" means the same in these rules as at 36 O.S. § 4405.1.

"Implementation" means the process by which OHCA and the MCO or DBM performs actions and responsibilities to actively implement a managed care program or contract for the first time. Implementation also means, depending on its use, the moment in time that such actions and responsibilities are fully completed.

"Implementation period" means the period of time, as defined in contract, during which implementation occurs.

"Indian health care provider" or "IHCP" means a health care program operated by the Indian Health Service (IHS) or by an Indian Tribe, Tribal Organization, or Urban Indian Organization (otherwise known as an I/T/U) as those terms are defined in section 4 of the Indian Health Care Improvement Act (25 U.S.C. § 1603).

"Initial enrollment" means an eligible's enrollment in an MCO or DBM during the initial enrollment period.

"Initial enrollment period" means the first period of time, as defined in contract, prior to or immediately following managed care program or contract implementation, when eligibles can first enroll in an MCO or DBM for the managed care program.

"Managed care organization" or "MCO" means a health plan designated as a managed care organization pursuant to 42 C.F.R. 438.2 and under contract with OHCA to participate in the managed care program and to deliver health care services to enrollees.

"Managed care program" or "managed care" or "MCP" means a health care delivery system organized to manage cost, utilization, and quality that is operated by a state as authorized under sections 1915(a), 1915(b), 1932(a), or 1115(a) of the Social Security Act and relevant state law.

"Manual" or "guide" means any document, outside of the Medicaid State Plan, any Medicaid waiver, and the rules, that is created by or for OHCA for use in interpreting or implementing contractual terms. "Manual" is synonymous with guide, guidebook, companion guide, manual, reference book, dictionary, handbook, model, instructions, primer, workbook, or any other words denoting a document that is handled as a matter of convenience.

"Material change" means, but not limited to, any change in the overall business operations such as policy, process or protocol which affects, or can reasonably be expected to affect, more than five percent (5%) of enrollees or participating providers of the MCO or DBM.

"Medical necessity" means a standard for evaluating the appropriateness of services as established under OAC 317:30-3-1.

"National Provider Identifier (NPI)" means a unique identification number for covered health care providers. Covered health care providers and all MCOs, DBMs, and health care clearinghouses must use an NPI in the administrative and financial transactions adopted under the Health Insurance Portability and Accountability Act (HIPAA). The NPI is a ten-position, intelligence-free numeric identifier (ten digit number). This means that the numbers do not carry other information about healthcare providers, such as the state in which they live or their medical specialty. The NPI must be used in lieu of legacy provider identifiers in the HIPAA standards transactions.

"Non-participating provider" means a physician or other provider who has not contracted with

or is not employed by the MCO or DBM to deliver services under the managed care program.

"Non-urgent sick visit" means medical care given for an acute onset of symptoms which is not emergent or urgent in nature but which requires face-to-face medical attention within seventy-two (72) hours of enrollee notification of a non-urgent condition, as clinically indicated. Examples of non-urgent sick visits include cold symptoms, sore throat, and nasal congestion.

"Open enrollment" means an eligible's selection of and enrollment in an MCO or DBM during the open enrollment period.

"Open enrollment period" means the annual period of time, as defined by contract, when managed care enrollees and eligibles can enroll in and select an MCO or DBM for the managed care program.

"Parent and caretaker relative" means an individual determined eligible under 42 C.F.R. § 435.110.

"Participating provider" means a physician or other provider who has a contract with or is employed by an MCO or DBM to provide health care services to enrollees under the capitated managed care delivery model of the managed care program.

"Patient-centered medical home" or **"PCMH"** means, in this chapter, the care coordinated delivery system as defined within the contract between OHCA and an MCO.

"Pregnant women" means women determined eligible for SoonerCare under 42 C.F.R. § 435.116.

"Presumptive eligibility" means limited period of managed care program eligibility for individuals who are categorically related to certain eligibility groups listed in OAC 317:35-6-38(a)(1)(A)(i) through (vi) and are also determined by a qualified hospital, on the basis of preliminary information provided by the applicant on a completed HPE application, to be eligible for managed care program services.

"Primary care dentist" or **"PCD"** means a provider under contract with a DBM to provide primary health care services, as contracted, and case management, including all medically necessary referrals for specialty services and prior authorizations. In these rules, "dental home provider" or "DH provider" bears the same meaning as "primary care dentist" or "PCD".

"Primary care provider" or **"PCP"** means a provider under contract with an MCO to provide primary health care services, as contracted, and case management, including securing all medically necessary referrals for specialty services and prior authorizations. In these rules, "patient-centered medical home provider" or "PCMH provider" bears the same meaning as "primary care provider" or "PCP".

"Prior authorization" or **"PA"** means a requirement that an enrollee, through the enrollee's provider, obtain the MCO's or DBM's approval before a requested medical service is provided or before services by a non-participating provider are received. Prior authorization is not a guarantee of claims payment; however, failure to obtain prior authorization may result in denial of the claim or reduction in payment of the claim.

"Provider" means a health care services provider licensed or certified in this State.

"Provider agreement" means an agreement between the MCO or DBM and a participating provider that describes the conditions under which the participating provider agrees to furnish covered health care services to enrollees.

"Risk contract" means a contract between OHCA and an MCO, prepaid inpatient health plan (PIHP), or prepaid ambulatory health plan (PAHP), as those terms are defined at 42 C.F.R. § 438.2, under which the contractor assumes risk for the cost of the services covered under the contract and incurs loss if the cost of furnishing the services exceeds the payments under the contract.

"SoonerCare" means the Oklahoma Medicaid program.

"Soon-To-Be-Sooner" means Oklahoma's separate CHIP providing coverage to unborn children

of families earning up to and including one hundred eighty-five percent (185%) of the FPL.

"Specialty Children's Plan" means the single statewide managed care plan, as contracted with a single MCO, that will coordinate and deliver health care services, as defined by contract, in a highly coordinated manner to the specialty population. The specialty population includes Medicaid eligibles who are FFC, select juvenile justice involved Office of Juvenile Affairs (OJA), in foster care (FC), children with an open prevention services case (PSC) through case workers or receiving adoption assistance (AA).

"State Plan" means an agreement between OHCA and CMS describing how Oklahoma administers its Medicaid and CHIP programs.

"Steady state enrollment" means the period of time, as defined by contract, when an individual, who first became an eligible during steady state operations or who became eligible again during steady state operations after more than two (2) months lapse of eligibility, can first enroll in and select an MCO or DBM for the managed care program.

"Steady state operations" or **"steady state"** means the period of time, as defined by contract, after initial implementation and prior to contract termination, during which all managed care program elements are expected to be operational.

"Third party liability" or **"TPL"** means all or part of the expenditures for a managed care enrollee's medical assistance furnished under the Oklahoma Medicaid State Plan that may be the liability of a third party individual, entity or program.

"Value added benefit" means any benefit or service offered by an MCO or DBM when that benefit or service is not a covered benefit per the State Plan. These benefits are subject to change annually as determined by the MCO or DBM and OHCA.

"Value based payment arrangement" means a payment arrangement between an MCO or DBM and its participating providers when payment is intentionally aligned with quality measures OHCA applies to the MCO or DBM.

"Value based purchasing" means the provisions of a contract for managed care services when those provisions intentionally align OHCA payments to the MCO or DBM under contract with quality measures or other performance factors OHCA may apply to the MCO or DBM.

The following words and terms, when used in this Chapter, shall have the following meaning, unless the context clearly indicates otherwise:

"1115(a) IMD waiver" means the 1115(a) Institutions for Mental Disease (IMD) demonstration waiver for individuals with Serious Mental Illness/Serious Emotional Disorder (SMI/SED) and Substance Use Disorder (SUD), as amended and including all active special terms and conditions (STCs) at a specific point in time, that authorizes Oklahoma Health Care Authority (OHCA) to operate a program in which one (1) or more requirements of Title XIX of the Social Security Act (Act) are waived based on the waiver authority of Section 1115 of the Act.

"1915(c) waiver" means any waiver, authorized by Section 1915(c) of the Act, that allows specific coverage of home and community-based services to a limited group of Medicaid-Eligible individuals as an alternative to institutional care.

"Abuse" means provider practices that are inconsistent with sound fiscal, business, or medical practices, and result in an unnecessary cost to the Medicaid program, or in reimbursement for services that are not medically necessary or that fail to meet professionally recognized standards for health care (as defined at 42 C.F.R. § 455.2). It also includes Eligible and Health Plan Enrollee practices that result in unnecessary cost to the Medicaid program.

"Accountable care organization" or **"ACO"** means a network of physicians, hospitals, and other health care providers that provide coordinated care to Medicaid members.

"Accrediting entity" means an entity recognized by CMS under 45 C.F.R. § 156.275. Current CMS-recognized accrediting entities include Accreditation Association for Ambulatory Health Care

(AAAHC), National Committee for Quality Assurance (NCQA) and Utilization Review Accreditation Commission (URAC). To the extent CMS recognizes additional accrediting entities, OHCA will also permit the CE or DBM to achieve accreditation from such entity to meet the requirements.

"Act" means the Social Security Act.

"Activities of daily living (ADL)" means activities that reflect the Health Plan Enrollee's ability to perform self-care tasks essential for sustaining health and safety such as: bathing; eating; dressing; grooming; transferring (includes getting in and out of the tub, bed to chair, etc.); mobility; toileting and bowel/bladder control. The services help with proper medical care, self-maintenance skills, personal hygiene, adequate food, shelter, and protection.

"Administrative remedies" means an action taken by the OHCA in response to the DBM's failure to comply with a requirement or performance standard. Remedies, include but are not limit to, liquidated damages, capitation payment suspension, auto-assignment suspension, contract termination, and any other remedies outlined in the Contract.

"Adult" means an individual twenty-one (21) years of age or older, unless otherwise specified by statute, regulation, and/or policy adopted by the OHCA. For eligibility criteria policy for children and adults, please refer to Oklahoma Administrative Code (OAC) 317:35-5-2.

"American Indian/Alaska Native" or "AI/AN" means any individual as defined in 25 U.S.C. §§ 1603(13), 1603(28) or 1679(a) or who has been determined Eligible as an Indian under 42 C.F.R. § 136.12.

"Appeal" means a review by an CE or DBM of an adverse benefit determination.

"Applicant" means an individual who seeks SoonerCare coverage.

"Authorized representative" means a competent adult who has the Enrollee's signed, written authorization to act on the Enrollee's behalf during the grievance, appeal, and state fair hearing process. The written authority to act will specify any limits of the representation.

"Behavioral health services" means a wide range of diagnostic, therapeutic and rehabilitative services used in the treatment of mental illness, substance abuse, and co-occurring disorders.

"Business days" means Monday through Friday and is exclusive of weekends and State of Oklahoma holidays.

"Calendar days" means all seven (7) days of the week, including State of Oklahoma holidays.

"Capitated contract" means a contract between OHCA and a contracted entity for the delivery of services to Medicaid members in which OHCA pays a fixed, per-member per-month rate based on actuarial calculations.

"Capitation payment" means a payment OHCA will make periodically to the CE or DBM on behalf of each Health Plan Enrollee enrolled under the SoonerSelect program and based on the actuarially sound capitation rate for the provision of services under the State Plan. OHCA shall make the payment regardless of whether the Health Plan Enrollee receives services during the period covered by the payment.

"Capitation rate" means the per Health Plan Enrollee, per-month amount, including any adjustments, that is paid by OHCA to the CE or DBM for each Health Plan Enrollee enrolled in the SoonerSelect program for the provision of services during the payment period.

"Care coordination/care management" means a process that assesses, plans, implements, coordinates, monitors, and evaluates the options and services required to meet the Health Plan Enrollee's needs using advocacy, communication, and resource management to promote quality and cost-effective interventions and outcomes. Based on the needs of the Health Plan Enrollee, the care manager arranges services and supports across the continuum of care, while ensuring that the care provided is person-centered.

"Care manager" means the CE's staff primarily responsible for delivering services to Health

Plan Enrollees in accordance with its OHCA-approved risk stratification level framework, and meets the qualifications specified in the Contract.

"Care plan" means a comprehensive set of actions and goals for the Health Plan Enrollee developed by the care manager based on the unique needs of Health Plan Enrollee(s). The CE shall develop and implement care plans for all Health Plan Enrollees with a special health care need determined through the comprehensive assessment to need a course of treatment or regular care monitoring and in accordance with Section 1.8.3: "Care Plans" of the Contract.

"Case file" means an electronic record that includes Enrollee information regarding the management of health care services including but not limited to: Enrollee demographics; comprehensive assessment (if applicable); care plan; reassessments; referrals and authorizations and Enrollee case notes.

"CEO" means Chief Executive Officer.

"Certified community behavioral health clinic (CCBHC or CCBH)" means entities designed to provide a comprehensive range of mental health and substance use disorder services as defined under the Excellence in Mental Health Act and certified by the Oklahoma Department of Mental Health and Substance Abuse Services.

"C.F.R." means the Code of Federal Regulations.

"Child" means an individual under twenty-one (21) years of age, unless otherwise specified by statute, regulation, and/or policy adopted by the OHCA. For eligibility criteria policy for children and adults, please refer to OAC 317:35-5-2.

"Children's Health Insurance Program" or "CHIP" means a Medicaid program authorized under Title XXI of the Social Security Act.

"Children's Specialty Plan" or "Children's Specialty Program" means the single statewide health care plan that covers all Medicaid services other than dental services and is designed to provide care to children in foster care children, former foster care children up to twenty-five (25) years of age, juvenile justice involved children, and children receiving adoption assistance.

"Child welfare services" means the Oklahoma Human Services (OKDHS) division responsible for administering Oklahoma's child welfare services.

"Choice counseling" means the provision of information and services designed to assist Eligibles in making enrollment decisions as described in 42 C.F.R § 438.2.

"Chronic condition" means a condition that is expected to last one (1) year or more and requires ongoing medical attention and/or limits activities of daily living (ADL).

"Civil monetary damage" means a damage imposed by OHCA which the CE must pay for acting or failing to act in accordance with 42 C.F.R. § 438.700 et seq. Amounts may not exceed those specified in 42 C.F.R. § 438.704.

"Clean claim" means a properly completed billing form with coding based on Current Procedural Terminology (CPT), fourth edition or a more recent edition, the tenth revision of the International Classification of Diseases (ICD) or a more recent revision, or Healthcare Common Procedure Coding System (HCPCS), where applicable, to provide information specifically required in the OHCA Provider Billing and Procedure Manual.

"CMS" means Centers for Medicare & Medicaid Services.

"Commercial plan" means an organization or entity that undertakes to provide or arrange for the delivery of health care services to Medicaid members on a prepaid basis and is subject to all applicable state and federal laws and regulations.

"Continuity of care period" means the ninety (90) day period immediately following an Enrollee's enrollment with the CE or DBM whereby established Enrollee and provider relationships, current services and existing prior authorizations and care plans shall remain in place.

"Contract" mean a result of receiving an award from OHCA and successfully meeting all

Readiness Review requirements, the agreement between the Contractor and OHCA where the Contractor will provide Medicaid services to SoonerSelect Enrollees, comprising of the Contract and any Contract addenda, appendices, attachments, or amendments thereto, and be paid by OHCA as described in the terms of the agreement.

"Contract year" means the period during which the Contract is in effect. The initial Contract year shall be from date of award through the end of the state fiscal year. Each subsequent Contract year shall be based on state fiscal year.

"Contracted entity" or "CE" means an organization or entity that enters into or will enter into a capitated contract with the Oklahoma Health Care Authority (OHCA) for the delivery of services that will assume financial risk, operational accountability, and statewide or regional functionality in this act in managing comprehensive health outcomes of Medicaid members. This includes an accountable care organization, a provider-led entity, a commercial plan, a dental benefit manager, or any other entity as determined by the OHCA.

"Contractor" means a contracted entity with which OHCA has entered into a binding agreement for the purpose of procuring services to SoonerSelect program Enrollees as specified in the Contract. The term "Contractor" includes all such Contractor's affiliates, agents, subsidiaries, any person with an ownership or control interest, officers, directors, manager, employees, independent contractors, and related parties working for or on behalf of the Contractor and other parties.

"Copayment" means a fixed amount that an Enrollee pays for a covered health care service when the Enrollee receives the service.

"Corrective action plan" or "CAP" means the detailed written plan that may be required by OHCA to correct or resolve a deficiency, event, or breach.

"Cost sharing" means the state's requirement that an Enrollee bear some of the cost of their care through mechanisms such as copayments, deductibles, and other similar charges.

"Critical incident" means any actual or alleged event or situation that creates a significant risk of substantial or serious harm to the physical or mental health, safety, or well-being of a SoonerSelect program Health Plan Enrollee.

"Deemed newborn" means children born to SoonerCare enrolled mothers and determined Eligible under 42 C.F.R. § 435.117.

"Dental benefits manager" or "DBM" means an entity that meets the definition of a Prepaid Ambulatory Health Plan (PAHP) as per 42 C.F.R. § 438.2 and is under contract with the OHCA to manage and deliver all services described in this SoonerSelect Dental Contract and who handles claims payment and prior authorizations and coordinates dental care with participating providers and Enrollees. Also referred to as a "Contractor".

"Dental related emergency services" means services provided to a SoonerSelect Dental Enrollee that are necessary for the treatment of any condition requiring immediate attention for the relief of pain, hemorrhage, acute infections, or traumatic injury to the teeth, supporting structures (periodontal membrane, gingival, alveolar bone), jaws, and tissue of the oral cavity.

"Disenrollment" means OHCA's removal of an Enrollee from participation in a specific CE or DBM or from participation in the SoonerSelect program.

"Dual eligible individuals" means individuals eligible for both Medicaid and Medicare.

"Eligible" means an individual who has been deemed Eligible for the SoonerSelect program but who is not yet enrolled in a CE or DBM.

"Emergency medical condition" means a medical condition, including injury, manifesting itself by acute symptoms of sufficient severity, including severe pain, that a prudent layperson who possesses an average knowledge of health and medicine could reasonably expect the absence of immediate medical attention to result in placing the individual's health, or the health of an unborn child, in serious jeopardy, serious impairment to bodily functions or serious dysfunction of any

bodily organs or parts.

"Emergency services" means medical services provided for a medical condition, including injury, manifesting itself by acute symptoms of sufficient severity, including severe pain, that a prudent layperson who possesses an average knowledge of health and medicine could reasonably expect the absence of immediate medical attention to result in placing the individual's health, or the health of an unborn child, in serious jeopardy, serious impairment to bodily functions or serious dysfunction of any bodily organs or parts.

"Encounter data" means information relating to the receipt of any item(s) or service(s) by an Enrollee under the Contract that is subject to the requirements of 42 C.F.R. §§ 438.242 and 438.818.

"Enrollee" means an individual who has been deemed Eligible for Medicaid in the State of Oklahoma, who has been deemed Eligible for enrollment in the SoonerSelect program, and who is currently enrolled in the SoonerSelect program.

"Enrollee handbook" means a guidebook that explains the SoonerSelect program that the Contactor shall distribute to every Enrollee. It shall be designed to help the Enrollee understand the CE or DBM, the SoonerSelect program and the rights and responsibilities that come with membership in the program.

"Enrollment" means the OHCA process by which an Eligible becomes an Enrollee with an CE or DBM.

"Essential community provider" means a provider defined by 45 C.F.R. § 156.235.

"Expansion adult" means an individual nineteen (19) or older and under age sixty-five (65), with income at or below one hundred thirty-eight percent (138%) of the federal poverty level (FPL) determined Eligible in accordance with 42 C.F.R. § 435.119), and who are not categorically related to the aged, blind, and disabled.

"Excluded populations" means populations that are excluded from participation in the SoonerSelect program as specified in the Contract.

"Federally Qualified Health Center (FQHC)" or "Health Centers" or "Centers" means an organization that qualifies for reimbursement under Section 330 of the Public Health Service Act. FQHCs qualify to receive enhanced reimbursements from Medicare and Medicaid, must serve an underserved population or area, offer a sliding fee scale, provide comprehensive services, have an ongoing quality assurance program, and have a governing board of directors.

"Former foster care children" or "FFC" means individuals under age twenty-six (26) determined Eligible in accordance with 42 C.F.R. § 435.150 who were in foster care under the responsibility of the State or an Indian Tribe within Oklahoma and enrolled in SoonerCare on the date of attaining age eighteen (18) or aging out of foster care.

"Foster care" means planned, goal-directed service that provides twenty-four (24) hour a day substitute temporary care and supportive services in a home environment for children birth to eighteen (18) years of age in OKDHS custody.

"Foster children (FC)" means children in foster care under the responsibility of the State, including children and youth who are in State custody due to abuse or neglect.

"FPL" means federal poverty level.

"Fraud" means intentional deception or misrepresentation made by a person with the knowledge that the deception could result in some unauthorized benefit to himself or some other person. It includes any act that constitutes fraud under applicable federal or state law.

"Grievance" means an Enrollee's expression of dissatisfaction about any matter other than an adverse benefit determination. Grievances may include, but are not limited to, the quality of care or services provided, aspects of interpersonal relationships such as rudeness of a provider or employee or failure to respect the Enrollee's rights regardless of whether remedial action is requested. A grievance includes an Enrollee's right to dispute an extension of time proposed by the CE or DBM to

make an authorization decision.

"Grievance and appeal system" means the processes the CE or DBM must implement in accordance with 42 C.F.R. Part 438, Subpart F, to handle Enrollee grievances and appeals, as well as the processes to collect and track information about them.

"Health care services" means all services outlined in the Oklahoma Medicaid State Plan, the Alternative Benefit Plan, and the 1115(a) IMD Waiver that are provided, according to contract, by the CE or DBM in any setting. Health care services may include but are not limited to medical care, behavioral health care, dental care, and pharmacy services.

"Health plan" means the same in these rules as at 36 O.S. § 4405.1.

"Hospitalization" means care in a hospital that requires admission as an inpatient and usually requires an overnight stay.

"Implementation" means the process by which OHCA and the CE or DBM performs actions and responsibilities to actively implement a managed care program or contract for the first time. Implementation also means, depending on its use, the moment in time that such actions and responsibilities are fully completed.

"Indian health care provider" or "IHCP" means a health care program operated by the Indian Health Service (IHS) or by an Indian Tribe, Tribal Organization, or Urban Indian Organization (otherwise known as an I/T/U) as those terms are defined in Section 4 of the Indian Health Care Improvement Act (25 U.S.C. § 1603).

"Initial enrollment" means an Eligible's enrollment in an CE or DBM during the initial enrollment period.

"Intermediate sanction(s)" means the sanctions described in 42 C.F.R § 438.702, which the OHCA may impose for the contracted entities non-compliance for any of the conditions in 42 C.F.R. § 438.700.

"Juvenile justice involved" means any person in custody or under the supervision of the Oklahoma Office of Juvenile Affairs (OJA) for whom OJA is required to provide services by law or court order.

"Manual" or "guide" means any document, outside of the Medicaid State Plan, any Medicaid waiver, and the rules, that is created by or for OHCA for use in interpreting or implementing contractual terms. "Manual" is synonymous with guide, guidebook, companion guide, manual, reference book, dictionary, handbook, model, instructions, primer, workbook, or any other words denoting a document that is handled as a matter of convenience.

"Medical necessity" or "medically necessary" means a standard for evaluating the appropriateness of services as established under OAC 317:30-3-1.

"National provider identifier (NPI)" means a unique identification number for covered health care providers. Covered health care providers and all CEs, DBMs, and health care clearinghouses must use an NPI in the administrative and financial transactions adopted under the Health Insurance Portability and Accountability Act (HIPAA). The NPI is a ten-position, intelligence-free numeric identifier (ten-digit number). This means that the numbers do not carry other information about healthcare providers, such as the state in which they live or their medical specialty. The NPI must be used in lieu of legacy provider identifiers in the HIPAA standards transactions.

"Non-compliance remedy" means an action taken by OHCA in response to the Contractor's failure to comply with a contract requirement or performance standard.

"Non-participating provider" means a physician or other provider who has not contracted with or is not employed by the CE or DBM to deliver services under the SoonerSelect program.

"Non-urgent sick visit" means medical care given for an acute onset of symptoms which is not emergent or urgent, but which requires face-to-face medical attention within seventy-two (72) hours of Enrollee notification of a non-urgent condition, as clinically indicated. Examples of non-urgent

sick visits include cold symptoms, sore throat, and nasal congestion.

"OAC" means Oklahoma Administrative Code.

"OHCA" means the Oklahoma Health Care Authority.

"OJA" means the Office of Juvenile Affairs.

"OKDHS" means the Oklahoma Department of Human Services which is also referenced in rules as Department of Human Services (DHS) and Office of Human Services (OHS).

"Open enrollment period" means the annual period of time, as defined by contract, when Enrollees and Eligibles can enroll in and select an CE or DBM for the SoonerSelect program.

"O.S." means Oklahoma Statutes.

"Parent and caretaker relative" means an individual determined Eligible under 42 C.F.R. § 435.110.

"Participating provider" means a physician or other provider who has a contract with or is employed by a CE or DBM to provide health care services to Enrollees under the SoonerSelect Medical or Dental program.

"Post-stabilization care services" means covered services related to an emergency medical condition that are provided after a Health Plan Enrollee is stabilized to maintain the stabilized condition or under the circumstances described in 42 C.F.R. § 438.114(e), to improve or resolve the Health Plan Enrollee's condition.

"Pregnant women" means women determined Eligible for SoonerCare under 42 C.F.R. § 435.116.

"Prepaid Ambulatory Health Plan" or "PAHP" means a DBM and/or an entity as per 42 C.F.R. § 438.2 that:

(A) Provides services to Enrollees under contract with the state, and on the basis of capitation payments, or other payment arrangements that do not use State Plan payment rates;

(B) Does not provide or arrange for, and is not otherwise responsible for the provision of any inpatient hospital or institutional services for its Enrollees; and

(C) Does not have a comprehensive risk contract.

"Prepaid dental plan" means a contractual arrangement in accordance with 36 O.S. § 6142, whereby any prepaid dental plan organization undertakes to provide payment of dental services directly, or to arrange for prepaid dental services, or to pay or make reimbursement for any dental services not provided for by other insurance.

"Prepaid dental plan organization" means any person who undertakes to conduct one (1) or more prepaid dental plans providing only dental services in accordance with 36 O.S. § 6142.

"Presumptive eligibility" means a period of temporary SoonerCare eligibility for individuals who are categorically related to certain eligibility groups listed in OAC 317:35-6-38(a)(1)(A)(i) through (vi) and are also determined by a qualified entity, on the basis of applicant self-attested income information, to meet the eligibility requirements for a Modified Adjusted Gross Income (MAGI) eligibility group.

"Primary care" means the provision of integrated, equitable, and accessible health care services by clinicians who are accountable for addressing a large majority of personal health care needs, developing a sustained partnership with patients, and practicing in the context of family and community.

"Primary care dentist" or "PCD" means a dental care professional providing comprehensive dental care for a Dental Health Plan Enrollee.

"Primary care provider" or "PCP" means the following:

(A) Family medicine physicians in an outpatient setting when practicing general primary care;

(B) General pediatric physicians and adolescent medicine physicians in an outpatient setting when practicing general primary care;

(C) Geriatric medicine physicians in an outpatient setting when practicing general primary care;

(D) Internal medicine physicians in an outpatient setting when practicing general primary care (excludes internists who subspecialize in areas such as cardiology, oncology, and other common internal medicine subspecialties beyond the scope of general primary care);

(E) Obstetrics and gynecology physicians in an outpatient setting when practicing general primary care;

(F) Providers such as nurse practitioners and physicians' assistants in an outpatient setting when practicing general primary care; or

(G) Behavioral health providers, including psychiatrists, providing mental health and substance use disorder services when integrated into a primary care setting.

"Prior authorization" or "PA" means a requirement that an Enrollee, through the Enrollee's provider, obtain the CE's or DBM's approval before a requested medical service is provided or before services by a non-participating provider are received. Prior authorization is not a guarantee of claims payment; however, failure to obtain prior authorization may result in denial of the claim or reduction in payment of the claim.

"Protected health information" or "PHI" means information considered to be individually identifiable health information, per 42 C.F.R. § 160.103.

"Provider" means a health care services provider licensed or certified in this State.

"Provider agreement" means an agreement between the CE or DBM and a participating provider that describes the conditions under which the participating provider agrees to furnish covered health care services to Enrollees.

"Provider-led entity" means an organization or entity that meets the criteria of at least one (1) of the following:

(A) A majority of the entity's ownership is held by Medicaid providers in this state or is held by an entity that directly or indirectly owns or is under common ownership with Medicaid providers in the state; or

(B) A majority of the entity's governing body is composed of individuals who:

(i) Have experience serving Medicaid members and:

(I) Are licensed in the state as physicians, physician assistants, nurse practitioners, certified nurse-midwives, or certified registered nurse anesthetists;

(II) At least one (1) board member is a licensed behavioral health provider; or

(III) Are employed by a hospital or other medical facility licensed by the state and operating in the state or an inpatient or outpatient mental health or substance abuse treatment facility or program licensed or certified by the state and operating in the state.

(ii) Represent the providers or facilities including, but not limited to, individuals who are employed by a statewide provider association; or

(iii) Are nonclinical administrators of clinical practices serving Medicaid members.

"Quality Assessment and Performance Improvement" or "QAPI" means a process designed to address and continuously improve CE and DBM quality metrics.

"Risk contract" means a contract between OHCA and a CE, prepaid inpatient health plan (PIHP), or prepaid ambulatory health plan (PAHP), as those terms are defined at 42 C.F.R. § 438.2, under which the Contractor assumes risk for the cost of the services covered under the contract and incurs loss if the cost of furnishing the services exceeds the payments under the Contract.

"Rural area" means a county with a population of less than fifty thousand (50,000) people.

"Rural Health Clinic" or "RHC" means clinics meeting the conditions to qualify for RHC reimbursement as stipulated in Section 330 of the Public Health Services Act.

"SoonerCare" means the Oklahoma Medicaid program.

"SoonerSelect" means the CEs and DBMs with whom the OHCA contracts with to provide SoonerCare covered medical, dental, pharmacy, and behavioral health benefits.

"Soon-To-Be-Sooner" means Oklahoma's separate CHIP providing coverage to unborn children of families earning up to and including one hundred eighty-five percent (185%) of the FPL.

"State Plan" means an agreement between OHCA and CMS describing how Oklahoma administers its Medicaid and CHIP programs.

"Steady state operations" or "steady state" means the time period beginning ninety (90) days after initial program implementation.

"Third party liability" or "TPL" means all or part of the expenditures for an Enrollee's medical or dental assistance furnished under the Oklahoma Medicaid State Plan that may be the liability of a third-party individual, entity, or program.

"Urban area" means a county with a population of fifty thousand (50,000) people or more.

"U.S.C." means United States Code.

"Value-added benefit" means any benefit or service offered by a CE or DBM when that benefit, or service is not a covered benefit per the State Plan. These benefits are subject to change annually as determined by the CE or DBM and OHCA.

"Value-based payment arrangement" means a payment arrangement between a CE or DBM and its participating providers when payment is intentionally aligned with quality measures OHCA applies to the CE or DBM.

"Waste" means the overutilization of services, or other practices that, directly or indirectly, result in unnecessary costs to the Medicaid program; generally, not considered to be caused by criminally negligent actions but rather the misuse of resources.

317:55-1-4. Eligible entities

Eligible entities. The OHCA shall enter into a capitated contract for the delivery of statewide Medicaid services. Eligible entities include an accountable care organization, a provider-led entity, a commercial plan, or any other entity as determined by OHCA. The CE or DBM shall meet the following requirements:

(1) Licensure and certificate of authority.

(A) The CE must be licensed as a Health Maintenance Organization (HMO) pursuant to 36 O.S. § 6901 et seq.

(B) The CE must furnish OHCA with a certificate of authority, to operate as an HMO, prior to contract implementation.

(C) The DBM must be licensed and authorized, as prepaid dental health plan, and able to transact dental business in the State of Oklahoma in accordance with 36 O.S. § 6141 et seq.

(D) The DBM must furnish OHCA with a certificate of authority for accident and health insurance or pre-paid dental prior to contract implementation in accordance with 36 O.S. § 703.

(E) Any changes to the certificate of authority, for CE and DBM, must be reported immediately to the OHCA.

(2) Accreditation. The CE or DBM shall seek accreditation from a private independent accrediting entity within eighteen (18) months of initial enrollment implementation. When undergoing accreditation, the CE or DBM shall submit reports documenting the status of the accreditation process as required in the Contract and reporting manual.

(A) **Accreditation review.** The CE or DBM shall authorize the accrediting entity to provide the OHCA a copy of the CE's or DBM's most recent accreditation review including:

(i) Accreditation status, survey type, and level (as applicable);

(ii) Accreditation results, including recommended actions or improvements, corrective action plans, and summaries of findings; and

(iii) Expiration date of the accreditation.

(B) **Reaccreditation.** The CE and DBM shall undergo reaccreditation in accordance with the timeframes required by the accrediting entity and federal regulations.

(C) **Health Equity Accreditation for CE.** The CE must earn Health Equity Accreditation from an accrediting entity in accordance with the contract terms.

(D) **Failure to achieve or maintain accreditation for a CE.** Failure to achieve or maintain accreditation shall be considered a breach of the CE Contract and may result in intermediate sanctions/penalties or termination in accordance with OAC 317:55-5-10(e).

(E) **Failure to achieve or maintain accreditation for a DBM.** Failure to achieve or maintain accreditation shall be considered a breach of the DBM Contract and may result in administrative remedies, including liquidated damages or termination, in accordance with OAC 317:50-5-11 and 317:55-5-12.

317:55-1-5. Program administration requirements

(a) **Compliance.** The CE or DBM shall comply with all applicable state and federal laws and regulations, including, but not limited to, 42 C.F.R. Part 438, and HIPAA privacy and security law, as defined in Section 3009 of the Public Health Service Act.

(b) **Subcontracting.** The CE or DBM shall seek approval from the OHCA prior to the effective date of any subcontract for performance of certain Contract responsibilities.

(1) The CE or DBM shall maintain ultimate responsibility for adhering to and otherwise fully complying with all terms and conditions of its Contract with OHCA, notwithstanding any relationship(s) with any subcontractors. The CE or DBM shall actively monitor subcontractors to ensure their compliance with the Contract and verify the quality of their services.

(2) The CE or DBM is prohibited from entering into any subcontract for the performance of any duty under the Contract in which such services are to be transmitted or performed outside of the United States.

(c) **Staffing.** The CE or DBM shall have sufficient staff to operate efficiently and meet all Contract obligations and standards. Additionally, the CE or DBM shall ensure staff and subcontractor staff receive detailed training on the requirements, policies, and procedures of the SoonerSelect program. All CE or DBM staff, including subcontractor staff, shall receive initial and ongoing training and education necessary to fulfill their job responsibilities under the Contract.

(d) **Policies and procedures.** The CE or DBM and any subcontractor shall:

(1) Develop and maintain written policies and procedures describing in detail how the CE or DBM and any subcontractor will fulfill the responsibilities outlined in the Contract.

(2) Submit all policies and procedures for OHCA's review and approval prior to adoption and implementation.

(3) Submit an annual certification in which the CE or DBM attests to the creation of updated policies and procedure.

(e) **Readiness review.**

(1) In accordance with 42 C.F.R. § 438.66(d)(1), the CE or DBM is required to participate, submit documentation, and satisfactorily pass the readiness review process in the following situations:

(A) Prior to initial implementation;

(B) When the specific CE or DBM has not previously contracted with the state; or

(C) When the CE or DBM, which is currently contracted with the state, will begin to provide, or arrange for covered benefits to new eligibility groups.

(2) All readiness review activities shall be completed to the satisfaction of OHCA and CMS pursuant to the Contract and/or any other policy guidelines/memorandum before being eligible to receive enrollment of Eligibles.

(3) Additionally, the state will conduct a desk review / optional on-site review of new subcontracts executed during the Contract term, or when the subcontract undertakes new eligibility groups or services. CEs, DBMs, and their subcontractors must adhere to all the contractual obligations found at 42 C.F.R. Part 438.

(f) **Marketing.** The CE or DBM must provide each Enrollee with an Enrollee handbook within ten (10) days and identification card within seven days (7) days after receiving notice of the Enrollee's enrollment or within ten (10) days of the Enrollee's request for the Enrollee handbook. The CE or DBM shall not falsify or misrepresent information that furnishes to an Enrollee, Eligible or provider. All marketing activities and materials shall comply with applicable laws and regulations regarding marketing by the Contractor and Contract terms. The OHCA shall approve all marketing materials, which must comply with federal funding requirements, including 42 C.F.R. § 438.10 and 42 C.F.R. § 438.104.

(g) **Accessibility.** The CE or DBM shall ensure Enrollees and providers have continuous access to information as determined by OHCA and that complies with the requirements at Section 508 of the Rehabilitation Act of 1973, Pub. L. No. 93-112, and the Oklahoma Electronic and Information Technology Accessibility law, 2004 HB 2197. To ensure ongoing accessibility standards are met, the CE or DBM shall:

(1) Provide its URL to the OHCA and any changes to the URL shall be approved by the OHCA.

(2) Assign and maintain a point of contact to assist the OHCA with interfacing/exchanging data in the CE's or DBM's system.

(h) **Disaster preparation and data recovery.** The CE and DBM shall submit to the OHCA and maintain a written disaster plan for information resources that will ensure service continuity as required by the Contract.

(i) **System performance.** The CE and DBM shall meet performance requirements pursuant to the Contract.

(j) **Call center standards.** The CE and DBM shall provide assistance to Enrollees and providers through a toll-free call-in system that meets the performance standards and requirements outlined in the Contract.

(k) **Failure to comply.** If the CE or DBM fails to comply with OAC 317:55-1-5, the OHCA may impose any or all the CE intermediate sanctions, found at OAC 317:55-5-10 and the CE Contract, or DBM administrative remedies, found at OAC 317:55-5-11 and the DBM Contract.

SUBCHAPTER 3. GENERAL PROGRAM INFORMATION

PART 1. ELIGIBILITY, ENROLLMENT AND CONTINUITY OF CARE

317:55-3-1. Mandatory populations Mandatory, voluntary, and excluded populations

(a) **Mandatory MCO enrollment.** Per 56 O.S. § 4002.3, eligibles in the following categories will be mandatorily enrolled in the MCP and with an MCO:-

(1) Expansion adults;

(2) Parents and caretaker relatives;

- (3) Pregnant women;
- (4) Deemed newborns;
- (5) Children; and
- (6) All other populations requiring mandatory coverage pursuant to in 42 C.F.R. Part 435, Subpart B (§§ 435.100-435.172), unless otherwise covered by SoonerCare.

(b) Mandatory Specialty Children's Plan enrollment. Per 56 O.S. § 4002.3, eligibles in the following categories, upon entering custody of the State, will be mandatorily enrolled in the MCP and with the MCO under contract to provide the Specialty Children's Plan:

- (1) Foster children (FC); and
- (2) Certain children in the custody of OJA.

(c) Mandatory Specialty Children's Plan enrollment, opt out. Per 56 O.S. § 4002.3, eligibles in the following categories will be mandatorily enrolled in the MCP and with the MCO under contract to provide the Specialty Children's Plan, if they do not select a different MCO during initial enrollment, open enrollment, or steady state enrollment:

- (1) Former foster care (FFC); and
- (2) Children receiving adoption assistance (AA).

(d) Mandatory DBM enrollment. Per 56 O.S. § 4002.3, the following eligibles will be mandatorily enrolled in the MCP and with a DBM:

- (1) Expansion adults;
- (2) Parents and caretaker relatives;
- (3) Pregnant women;
- (4) Deemed newborns;
- (5) Former foster children;
- (6) Certain children in the custody of OJA;
- (7) Foster care children;
- (8) Children receiving adoption assistance; and
- (9) Children.

(a) Mandatory populations. The following SoonerCare Eligibles will be mandatorily enrolled with a CE and DBM under the SoonerSelect Dental and Medical program:

- (1) Expansion adults;
- (2) Parents and caretaker relatives;
- (3) Pregnant women;
- (4) Deemed newborns;
- (5) Former foster children;
- (6) Juvenile justice involved children;
- (7) Foster care children;
- (8) Children receiving adoption assistance; and
- (9) Children.

(b) Voluntary populations. SoonerCare Eligible individuals may voluntarily choose to enroll in the SoonerSelect Dental and Medical program through an opt-in process if they are American Indians and/or Alaskan Natives. AI/AN populations will have the option to:

- (1) Voluntarily enroll in the DBM and/or CE through an opt-in process;
- (2) Enroll in a DBM and/or CE at each open enrollment period, regardless of initial selection or past disenrollment from the DBM and/or CE;
- (3) When enrolled, AI/AN populations may:
 - (A) Receive services from an IHCP;
 - (B) Choose the IHCP as the Enrollee's provider, if the provider has the capacity to provide such services;

(C) Obtain services covered under the Contract from out-of-network IHCPs when the Enrollee is otherwise Eligible to receive the IHCP's services;

(D) Self-refer for services provided by IHCPs to AI/AN Enrollees;

(E) Obtain services covered under the Contract from out-of-network IHCPs when the AI/AN Enrollee is otherwise Eligible to receive the IHCP's services; and

(F) Disenroll from any DBM and/or CE at any time without cause.

(c) **Excluded populations.** The following individuals are excluded from enrollment in the SoonerSelect program:

(1) Dual-eligible individuals;

(2) Individuals enrolled in the Medicare Savings Program, including Qualified Medicare Beneficiaries (QMB), Specified Low Income Medicare Beneficiaries (SLMB), Qualified Disabled Workers (QDW) and Qualified Individuals (QI);

(3) Persons with a nursing facility or ICF-IID level of care, except for Enrollees with a pending level of care determination;

(4) Individuals during a period of presumptive eligibility;

(5) Individuals infected with tuberculosis Eligible for tuberculosis-related services under 42 C.F.R. § 435.215;

(6) Individuals determined Eligible for SoonerCare on the basis of needing treatment for breast or cervical cancer under 42 C.F.R. § 435.213;

(7) Individuals enrolled in a § 1915(c) Waiver;

(8) Undocumented persons Eligible for emergency services only in accordance with 42 C.F.R. § 435.139;

(9) Insure Oklahoma Employee Sponsored Insurance (ESI) dependent children in accordance with the Oklahoma Medicaid State Plan;

(10) Coverage of Pregnancy-Related Services under Title XXI for the benefit of unborn children ('Soon- to-be-Sooners'), as allowed by 42 C.F.R. § 457.10; and

(11) Individuals determined Eligible for Medicaid on the basis of age, blindness, or disability.

(d) **Additional eligibility criteria.** For additional eligibility criteria, refer to Chapter 35 Medical Assistance for Adults and Children Eligibility Manual, Subchapter 5 Eligibility and Countable Income.

317:55-3-2. Excluded populations Enrollment and disenrollment process

(a) Per 56 O.S. § 4002.3, individuals in the following categories will be excluded from enrollment in a MCP contracted with one (1) or more MCOs:

(1) Dual eligible individuals;

(2) Individuals enrolled in the Medicare Savings Program, including Qualified Medicare Beneficiaries (QMB), Specified Low Income Medicare Beneficiaries (SLMB), Qualified Disabled Workers (QDW) and Qualified Individuals (QI);

(3) Persons with a nursing facility or intermediate care facility for individuals with intellectual disabilities (ICF/IID) level of care, except that enrollees who are transitioning into long term care will remain enrolled in any MCO for up to sixty (60) days while the enrollee's level of care determination is pending. Prior to disenrollment from an MCO, such excepted enrollees will receive a facility's pre-admission screening and resident review (PASRR) process. If OHCA approves the PASRR and designates the nursing facility or ICF/IID level of care, reimbursement will be made to the facility and the enrollee will be disenrolled from their MCO;

(4) Individuals during a period of presumptive eligibility;

(5) Individuals infected with tuberculosis eligible for tuberculosis related services under 42 C.F.R. § 435.215;

- (6) Individuals determined eligible for SoonerCare on the basis of needing treatment for breast or cervical cancer under 42 C.F.R. § 435.213;
 - (7) Individuals enrolled in a 1915(c) waiver;
 - (8) Undocumented persons eligible for emergency services only in accordance with 42 C.F.R. § 435.139;
 - (9) Insure Oklahoma employee sponsored insurance (ESI) dependent children in accordance with the Oklahoma Title XXI State Plan;
 - (10) Coverage of pregnancy related services under Title XXI for the benefit of unborn children (Soon to be Sooners), as allowed by 42 C.F.R. § 457.10; and
 - (11) Individuals determined eligible for Medicaid on the basis of age, blindness or disability.
- (b) Per 56 O.S. § 4002.3, eligibles in the following categories will be excluded from enrollment in a MCP contracted with one (1) or more DBMs:
- (1) Dual eligible individuals;
 - (2) Individuals enrolled in the Medicare Savings Program, including QMB, SLMB, QDW and QI;
 - (3) Persons with a nursing facility or ICF-HD level of care, except that enrollees who are transitioning into long term care will remain enrolled in any DBM for up to sixty (60) days while the enrollee's level of care determination is pending. Prior to disenrollment from a DBM, such excepted enrollees will receive a facility's PASRR process. If OHCA approves the PASRR and designates the nursing facility or ICF/HD level of care, reimbursement will be made to the facility and the enrollee will be disenrolled from the DBM.
 - (4) Individuals during a period of presumptive eligibility;
 - (5) Individuals infected with tuberculosis eligible for tuberculosis related services under 42 C.F.R. § 435.215;
 - (6) Individuals determined eligible for SoonerCare on the basis of needing treatment for breast or cervical cancer under 42 C.F.R. § 435.213;
 - (7) Individuals enrolled in a §1915(c) waiver;
 - (8) Undocumented persons eligible only for emergency services in accordance with 42 C.F.R. § 435.139;
 - (9) Insure Oklahoma Employee Sponsored Insurance (ESI) dependent children in accordance with the Oklahoma Title XXI State Plan;
 - (10) Coverage of Pregnancy related services under Title XXI for the benefit of unborn children (Soon to be Sooners), as allowed by 42 C.F.R. § 457.10; and
 - (11) Individuals determined eligible for Medicaid on the basis of age, blindness or disability.
- (a) Enrollment process.** The OHCA beneficiary support system will provide choice counseling to all potential Enrollees at the time of initial enrollment, during the annual open enrollment period and for Enrollees who disenroll from a CE or DBM for good cause as described in the Contract and in this Section. The OHCA, or its designee, will provide information about individual CE or DBM benefit structures, services, and network providers, as well as information about other Medicaid programs as requested by the Eligible to assist the Eligible in making an informed selection.
- (1) Selection/auto assignment.** During the application process, at OHCA's discretion, an Applicant may have up to sixty (60) days to select a contracted CE and DBM of their choice. Applicants who are Eligible to choose a CE and DBM and fail to make an election on the SoonerCare application, within the allotted timeframe, will be assigned to the CE and DBM that is due next to receive an auto assignment.
 - (2) Exemptions to auto-assignments**
 - (A) The OHCA will not make auto-assignments to the CE if:**
 - (i) The CE's maximum enrollment has been capped and actual enrollment has reached**

ninety-five percent (95%) of the cap;

(ii) The CE has been excluded from receiving new enrollment due to the application of non-compliance remedies; or

(iii) The CE has failed to meet readiness review requirements.

(B) The OHCA will not make auto-assignments to the DMB if:

(i) The DBM's maximum enrollment has been capped and actual enrollment has reached ninety-five percent (95%) of the cap;

(ii) The DBM has been excluded from receiving new enrollment due to the imposition of administrative remedies; or

(iii) The DBM has failed to meet readiness review requirements.

(3) Enrollment effective date

(A) Eligibles, with the exception of deemed newborns, who select or are assigned to a CE and/or DBM from the first day of the month through the fifteenth day of the month shall be enrolled effective on the first day of the following month.

(B) Eligibles who select or are assigned to a CE and/or DBM on the sixteenth (16th) day of the month through the last day of the month will be enrolled effective on the first day of the second following month.

(C) Prior to these enrollment dates, most Eligibles will be covered by a fee-for-service payment structure administered by OHCA.

(D) Deemed newborns eligible for the CE and/or DBM shall be enrolled effective as of the date of birth, if the newborn's mother also is enrolled in the SoonerSelect program.

(E) Notwithstanding the foregoing, the effective date of enrollment with the CE or DBM shall be the date recorded on the outbound ANSI ASC X 12 834 electronic transaction sent by OHCA.

(4) Enrollment lock-in period. An Enrollee may, within the first ninety (90) days of initial enrollment, request to change enrollment without cause from the CE and/or DBM, or during the ninety (90) days following the date OHCA sends the Enrollee notice of initial enrollment, whichever is later. Enrollees will also be permitted to change CEs and/or DBMs, without cause, at least once every twelve (12) months during the open enrollment period. After the disenrollment period from the CE or DBM has lapsed, the Enrollee will remain enrolled with the CE or DBM until the next annual open enrollment period, unless:

(A) The SoonerSelect Medical Enrollee:

(i) Is disenrolled due to loss of SoonerCare eligibility;

(ii) Becomes a foster child under custody of the state;

(iii) Becomes juvenile justice involved under the custody of the state;

(iv) Is a former foster care or child receiving adoption assistance and opts to enroll in the SoonerSelect Children's Specialty program;

(v) Demonstrates good cause under the following conditions:

(I) The Enrollee moves out of the service area;

(II) The Enrollee requires specialized care for a chronic condition and the Enrollee or Enrollee's representative, the CE, OHCA and receiving CE agree that assignment to the receiving CE is in the Enrollee's best interest;

(III) The plan does not cover the service the Enrollee seeks, because of moral or religious objections;

(IV) The Enrollee needs related services to be performed at the same time; not all related services are available within the CE's network; and the Enrollee's primary care provider or another provider determines that receiving the services separately would subject the Enrollee to unnecessary risk;

(V) For other reasons, including a filed and prevailed grievance related to poor quality of care, lack of access to services covered under the Contract, or lack of access to providers experienced in dealing with the Enrollee's oral health care needs or other matters deemed sufficient to warrant disenrollment; and

(VI) The Enrollee has been enrolled in error, as determined by the OHCA.

(vi) Experiences a temporary loss of eligibility or enrollment which caused the Enrollee to miss the annual disenrollment period, then the Enrollee may disenroll without cause upon reenrollment; or

(vii) The OHCA has imposed intermediate sanctions on the CE and allows Enrollees to disenroll without cause.

(B) The SoonerSelect Dental Enrollee:

(i) Is disenrolled due to loss of SoonerCare eligibility;

(ii) Demonstrates good cause under the following conditions:

(I) The Enrollee moves out of the service area;

(II) The plan does not cover the service the Enrollee seeks, because of moral or religious objections;

(III) The Enrollee needs related services to be performed at the same time; not all related services are available within the DBM's network; and the Enrollee's primary care dental provider or another provider determines that receiving the services separately would subject the Enrollee to unnecessary risk;

(IV) For other reasons, including a filed and prevailed grievance related to poor quality of care, lack of access to services covered under the Contract, or lack of access to providers experienced in dealing with the Enrollee's oral health care needs or other matters deemed sufficient to warrant disenrollment; and

(V) The Enrollee has been enrolled in error, as determined by the OHCA.

(iii) Experiences a temporary loss of eligibility or enrollment which caused the Enrollee to miss the annual disenrollment period, then the Enrollee may disenroll without cause upon reenrollment; or

(iv) The DBM is terminated.

(5) **Annual and special enrollment periods.** Sixty (60) days prior to the start of the Enrollee's annual open enrollment period, the Enrollee shall be notified of the option to maintain enrollment with the current CE and/or DBM or to enroll with a different CE and/or DBM. OHCA, at its sole discretion, may schedule a special open enrollment period, under the following circumstances:

(A) In the event of the early termination of a CE or DBM under the process described in the Contract; or

(B) The loss of a major participating provider(s) places the CE or DBM at risk of failing to meet service accessibility standards and the CE or DBM does not have an acceptable plan for mitigating the loss or finding of non-compliance.

(6) **Enrollment caps.** OHCA, at its sole discretion, may impose a cap on the CE or DBM's enrollment, in response to a request by the CE or DBM or as part of a corrective action in accordance to the respective Contract.

(b) **Disenrollment.** The OHCA shall have sole authority to grant or deny a disenrollment request from the Enrollee, and/or CE or DBM.

(1) **CE or DBM-requested disenrollment.** Pursuant to 42 C.F.R. § 438.56(b)(2), the CE or DBM cannot request a disenrollment based on adverse change in the member's health status or utilization of medically necessary services, diminished mental capacity, or uncooperative or disruptive behavior resulting from their special needs, except when their continued Enrollment

with the Contractor seriously impairs the Contractor's ability to furnish services to either this particular Enrollee or other Enrollees.

(A) The CE may only request disenrollment of the Enrollee only for good cause. The following actions, if found by OHCA, comprise good cause:

(i) The Enrollee requires specialized care for a chronic condition and the Enrollee or Enrollee's representative, the CE, OHCA and receiving CE agree that assignment to the receiving CE is in the Enrollee's best interest;

(ii) The Enrollee has been enrolled in error, as determined by OHCA;

(iii) The Enrollee has exhibited disruptive behaviors to the extent the CE cannot effectively manage their care, and the CE has made all reasonable efforts to accommodate the Enrollee; or

(iv) The Enrollee has committed fraud, including but not limited to, loaning an identification (ID) card for use by another person.

(B) The DBM may only request disenrollment of the Enrollee only for good cause. The following actions, if found by OHCA, comprise good cause:

(i) The Enrollee has been enrolled in error, as determined by OHCA;

(ii) The Enrollee has exhibited disruptive behaviors to the extent the DBM cannot effectively manage their care, and the DBM has made all reasonable efforts to accommodate the Enrollee; or

(iii) The Enrollee has committed fraud, including but not limited to, loaning an ID card for use by another person.

(2) **Enrollee-requested disenrollment.** Enrollees shall seek redress through the CE's or DBM's grievance process before OHCA will make a determination on an Enrollee's request for disenrollment. The CE or DBM shall accept Enrollee requests for disenrollment orally or in writing. The CE or DBM shall complete a review of the request within ten (10) days of the Enrollee filing the grievance. If the Enrollee remains dissatisfied with the result of the grievance process, the CE or DBM shall refer the disenrollment request to OHCA. The Contractor shall send records gathered during the grievance process to OHCA to facilitate OHCA's decision-making process. Disenrollment requests will be adjudicated by OHCA and, if approved, will become effective on a date established by OHCA.

(A) The Enrollee may request disenrollment from the CE or DBM as allowed by 42 C.F.R. § 438.56(c).

(B) An Enrollee may request disenrollment from the CE or DBM at any time based on any cause listed at 42 C.F.R. § 438.56(d)(2).

(C) An Enrollee may request disenrollment at any time in accordance with (a)(4)(A)(v)(I)-(VI) and (B)(ii)(I)-(V) of this Section and the applicable Contract.

(3) **Disenrollment by OHCA.** The CE or DBM shall report to OHCA, within five (5) business days of learning of any change in an Enrollee's status affecting the Enrollee's eligibility.

(A) The OHCA will initiate disenrollment of SoonerSelect Medical Enrollees under the following circumstances:

(i) Loss of eligibility for Medicaid;

(ii) Transition to a SoonerCare eligibility group excluded from the SoonerSelect Medical program;

(iii) Enrollee becomes enrolled in Medicare;

(iv) Death;

(v) Enrollee becomes a foster child under the custody of the state;

(vi) Enrollee becomes juvenile justice involved under the custody of the state;

(vii) The Enrollee becomes an inmate of a public institution;

(viii) The Enrollee commits fraud or provides fraudulent information; or

(ix) Disenrollment is ordered by a hearing officer or court of law.

(B) The OHCA will initiate disenrollment of SoonerSelect Dental Enrollees under the following circumstances:

(i) Loss of eligibility for Medicaid;

(ii) Transition to a SoonerCare eligibility group excluded from the SoonerSelect Dental program;

(iii) Enrollee becomes enrolled in Medicare;

(iv) Death;

(v) The Enrollee becomes an inmate of a public institution;

(vi) The Enrollee commits fraud or provides fraudulent information; or

(vii) Disenrollment is ordered by a hearing officer or court of law.

(4) Disenrollment effective date. Consistent with 42 C.F.R. § 438.56(e), except as provided for below, and unless OHCA determines that a delay would have an adverse effect on an Enrollee's health, it is OHCA's intent that a disenrollment shall be effective no later than the first day of the second following month.

(A) Grievance resolution for poor quality of care, lack of access to services covered under the Contract or lack of access to providers experienced in dealing with the Enrollee's health care needs or other matters deemed sufficient to warrant disenrollment under (b)(2) of this Section must be completed within this timeframe. If the CE fails to complete the grievance process in time to permit disenrollment by OHCA, the disenrollment shall be considered approved for the effective date that would have been established had the CE complied with this timeframe. Disenrollment for any of the following reasons shall be effective as of the date that the Enrollee's SoonerSelect Medical program eligibility status changes:

(i) Loss of eligibility for Medicaid;

(ii) Transition to a SoonerCare eligibility group excluded from the SoonerSelect program;

(iii) Enrollee becomes a foster child under the custody of the state;

(iv) Enrollee becomes JJ Involved under the custody of the state;

(v) Enrollee becomes eligible for Medicare;

(vi) Death;

(vii) Enrollee becomes an inmate of a public institution;

(viii) Enrollee commits fraud or provides fraudulent information;

(ix) Disenrollment is ordered by a hearing officer or court of law; or

(x) Enrollee requiring long-term care.

(I) Enrollees requiring long-term care in a nursing facility or ICF-IID shall be disenrolled from the CE when the level of care determination is finalized.

(II) For additional information regarding nursing facility and ICF-IID stays, refer to the Contract.

(B) Grievance resolution for poor quality of care, lack of access to services covered under the Contract or lack of access to providers experienced in dealing with the SoonerSelect Dental Enrollee's oral health care needs, or other matters deemed sufficient to warrant disenrollment under (b)(2) of this Section must be completed within this timeframe. If the Contractor fails to complete the grievance process in time to permit disenrollment by OHCA, the disenrollment shall be considered approved for the effective date that would have been established had the Contractor complied with this timeframe. Disenrollment for any of the following reasons shall be effective as of the date that the SoonerSelect Dental Enrollee's SoonerSelect Dental program eligibility status changes:

- (i) Loss of eligibility for Medicaid;
- (ii) Transition to a SoonerCare eligibility group excluded from the SoonerSelect Dental program;
- (iii) SoonerSelect Dental Enrollee becomes eligible for Medicare;
- (iv) Death;
- (v) SoonerSelect Dental Enrollee becomes an inmate of a public institution;
- (vi) SoonerSelect Dental Enrollee commits Fraud or provides fraudulent information;
- (vii) Disenrollment is ordered by a hearing officer or court of law; or
- (viii) SoonerSelect Dental Enrollees requiring long-term care in a nursing facility or ICF-IID shall be disenrolled from the Contractor when the level of care determination being done by the SoonerSelect or SoonerSelect Children's Specialty CEs is complete.

(C) Notwithstanding the foregoing, the effective date of disenrollment from the Contractor shall be the date recorded on the outbound ANSI ASC X 12 834 electronic transaction sent by OHCA.

(c) **Retroactive dual eligibility.** Dual eligibles are excluded from the SoonerSelect program. SoonerSelect Enrollees who become dual eligible individuals will be disenrolled as of their Medicare eligibility effective date.

(1) In the event a SoonerSelect Enrollee becomes retroactively Medicare eligible, the CE or DBM shall recover claims payments made to providers during the months of retroactive Medicare eligibility.

(2) The CE or DBM shall also notify the provider of the requirement to submit the claim to Medicare for reimbursement.

(3) OHCA will recoup the capitation payments paid for months of retroactive Medicare eligibility.

(d) **Re-enrollment following loss of eligibility.** Enrollees who lose and regain eligibility for SoonerSelect Medical or Dental program within a period of sixty (60) days or less will be re-enrolled automatically with their prior CE and/or DBM unless the CE and/or DBM is otherwise suspended or excluded from receiving new Enrollees. Re-enrolled Enrollees will have the right to change CE/DBM in accordance with this Section and the Contract.

(e) **Eligibles voluntarily opting out of SoonerSelect Children's Specialty Program.** FFC and children receiving adoption assistance shall be enrolled in the SoonerSelect Children's Specialty Program. These Eligibles may opt-out of enrollment in the Children's Specialty Program; however, the legal guardian of the Eligible will be required to enroll the Eligible with a CE.

(f) **Non-discrimination.** The CE or DBM may not refuse an assignment or seek to disenroll an Enrollee or otherwise discriminate against Eligible to enroll on the basis of race, color, national origin, sex, sexual orientation, gender identity, health status, need for medical services, or disability and may not use any policy or practice that has the effect of discriminating on the basis of race, color or national origin, sex, sexual orientation, gender identity, or disability. The Contractor also may not discriminate against an Enrollee on the basis of expectations that the Enrollee will require frequent or high-cost care, or on the basis of health status or need for health care services or due to an adverse change in the Enrollee's health in enrollment, disenrollment, or re-enrollment. If the CE or DBM fails to comply with OAC 317:55-3-2, the OHCA may impose any or all the CE intermediate sanctions, found at OAC 317:55-5-10 and the CE Contract, or DBM administrative remedies, found at OAC 317:55-5-11 and the DBM Contract.

317:55-3-3. Voluntary enrollment and disenrollment Enrollee rights

(a) Per 56 O.S. § 4002.3, AI/AN populations that are eligible for SoonerCare will have the option to:

- (1) Voluntarily enroll in the MCP through an opt-in process;

- (2) Enroll in an MCO or DBM at each open enrollment period, regardless of initial selection or past disenrollment from the MCP;
 - (3) Receive services from an IHCP;
 - (4) Choose the IHCP as the enrollee's PCMH provider or DH provider, if the provider has the capacity to provide such services;
 - (5) Obtain services covered under the contract from out-of-network IHCPs when the enrollee is otherwise eligible to receive the IHCP's services;
 - (6) Self refer for services provided by IHCPs to AI/AN enrollees;
 - (7) Obtain services covered under the contract from out-of-network IHCPs when the AI/AN enrollee is otherwise eligible to receive the IHCP's services; and
 - (8) Disenroll from any MCO or DBM at any time without cause.
- (b) Children receiving prevention services from child welfare services have the option to enroll in the MCO contract to provide health care services under the Specialty Children's Plan.
- (a) In accordance with 42 C.F.R. § 438.100, state and federal regulations, and all contractual requirements, the CE and DBM shall allow the Enrollee the right to:
- (1) Receive information on the SoonerSelect program and the CE or DBM;
 - (2) Receive information on all available treatment options and alternatives;
 - (3) Participate in decisions regarding their healthcare;
 - (4) Free from any form of restraint or seclusion used as a means of coercion, discipline, convenience, or retaliation; and
 - (5) Request and receive a copy of their medical records in accordance with all HIPAA rules.
- (b) Each Enrollee is free to exercise their rights without the CE or DBM treating them adversely.
- (c) The CE or DBM may not otherwise discriminate against Enrollees on the basis of race, color, national origin, sex, sexual orientation, gender identity, health status, need for medical services, or disability and may not use any policy or practice that has the effect of discriminating on the basis of race, color or national origin, sex, sexual orientation, gender identity, or disability. If the CE or DBM fails to comply with OAC 317:55-3-3, the OHCA may impose any or all the CE intermediate sanctions, found at OAC 317:55-5-10 and the CE Contract, or DBM administrative remedies, found at OAC 317:55-5-11 and the DBM Contract.

PART 3. SCOPE AND ADMINISTRATION ACCESS TO COVERED SERVICES AND PROVIDER NETWORK STANDARDS

317:55-3-10. Grievances and appeals Covered services

- (a) **Filing.** ~~Grievances and appeals are to be initially filed with each enrollee's MCO or DBM. Grievances may be filed with the enrollee's MCO or DBM at any time, either orally or in writing. A provider or an authorized representative may file an appeal, grievance, or request for a State fair hearing on behalf of an enrollee, provided that the provider or authorized representative has obtained the enrollee's written consent.~~
- (b) **Levels of appeal.** Pursuant to 42 C.F.R. § 438.402, ~~MCOs and DBMs will only have one (1) level of appeal. Enrollees and providers may file an appeal to OHCA seeking the review of a final adverse benefit determination rendered by an MCO or DBM.~~
- (c) **Governing rules.** ~~The provisions at OAC 317:2-1-1 et seq. will govern any enrollee or provider right to file a grievance, complaint, appeal or request for a State fair hearing pursuant to 56 O.S. § 4002-4004, 42 C.F.R. Parts 431 or 438, or the managed care contract.~~
- (a) Amount, duration, and scope of services. The CE or DBM must ensure members have timely access to all medically necessary services, as applicable, covered by SoonerCare under the Medicaid

State Plan, the Alternative Benefit Plan (ABP), and the 1115(a) IMD Waiver. The CE or DBM must ensure:

(1) Services are sufficient in amount, duration, and scope to reasonably be expected to achieve the purpose for which the services are provided;

(2) The amount, duration, and scope of a required service is not arbitrarily denied or reduced solely because of the diagnosis, type of illness, or condition;

(3) PA is available for services on which the CE or DBM has placed a pre-identified limitation to ensure the limitation may be exceeded when medically necessary.

(A) The CE or DBM may propose to impose alternative PA requirements, subject to OHCA's review and approval, except for those benefits identified as exempt from PA. The CE or DBM may be less restrictive on the requirements of a PA than OHCA but may not impose greater restrictions.

(B) PA shall be processed in accordance with timeliness requirements specified in the Contract.

(4) Coverage decisions are based on the coverage and medical necessity criteria published in Title 317 of the Oklahoma Administrative Code and practice guidelines/manual; and

(5) If a member is unable to obtain medically necessary services offered by SoonerCare from a CE or DBM network provider, the CE or DBM must adequately and timely cover the services out of network, until the CE or DBM is able to provide the services from a network provider.

(b) **Emergency services.** The CE or DBM shall provide emergency services to Enrollees in accordance with the respective CE or DBM Contract.

(c) **Post-stabilization services.** In accordance with the provisions set forth at 42 C.F.R. § 422.113(c), the CE shall provide post-stabilization care services are:

(1) Obtained within or outside the CE network that are:

(A) Pre-approved by a CE or representative; or

(B) Not pre-approved by a CE or representative but administered to maintain the Enrollee's stabilized condition within one (1) hour of a request to the CE for pre-approval of further post-stabilization care services.

(2) Administered to maintain, improve, or resolve the Enrollee's stabilized condition without preauthorization, and regardless of whether the Enrollee obtains the services within the CE network when the CE:

(A) Did not respond to a request for pre-approval within one (1) hour;

(B) Could not be contacted; or

(C) Representative and the treating physician could not reach agreement concerning the Enrollee's care and a CE physician was not available for consultation.

(3) In accordance with 42 C.F.R. §§ 438.114(e) and 422.113(c)(2)(iv), the CE shall limit charges to Enrollees for post-stabilization care services to an amount no greater than what the CE would charge the Enrollee if they obtained the services through the CE. Additionally, the CE's financial responsibility for post-stabilization care services if not pre-approved ends when:

(A) A CE physician with privileges at the treating hospital assumes responsibility for the Enrollee's care;

(B) A CE physician assumes responsibility for the Enrollee's care through transfer;

(C) A CE representative and the treating physician reach an agreement concerning the Enrollee's care; or

(D) The Enrollee is discharged.

(d) **Continued services to Enrollees.** The CE and DBM shall take all the necessary steps to ensure continuity of care when Enrollees transition to the CE or DBM from another CE/DBM or SoonerCare program. The CE and DBM shall ensure that established Enrollee and provider

relationships, current services and existing PAs and care plans will remain in place during the continuity of care period in accordance with the requirements outlined in this Section.

(1) Transition to the CE/DBM shall be as seamless as possible for Enrollees and their providers.

(2) The CE shall take special care to provide continuity of care for newly enrolled Enrollees who have physical health conditions, behavioral health conditions and/or functional needs and are under the care of existing treatment providers and whose health could be placed in jeopardy, or who could be placed at risk of hospitalization or institutionalization, if covered services are disrupted or interrupted.

(3) The DBM shall take special care to provide continuity of care for newly enrolled SoonerSelect Dental Enrollees who have oral health care needs and are under the care of existing treatment providers and whose health could be placed in jeopardy, or who could be placed at risk of hospitalization, if covered services are disrupted or interrupted.

(4) The DBM shall work with SoonerSelect and SoonerSelect Children's Specialty CEs to transition and coordinate care after a dental related emergency service pursuant to the Contract.

(5) The CE/DBM shall make transition of care policies available to Enrollees and provide instructions to Enrollees on how to access continued services during the continuity of care period.

(6) The CE/DBM shall ensure that all Enrollees are held harmless by providers for payment for any existing covered services, other than required cost sharing, during the continuity of care period.

(e) **Non discrimination.** The CE or DBM shall not discriminate an Enrollee on the basis of the Enrollee's health or need for medical services.

(f) **Failure to comply.** If the CE or DBM fails to comply with OAC 317:55-3-10, the OHCA may impose any or all the CE intermediate sanctions, found at OAC 317:55-5-10 and the CE Contract, or DBM administrative remedies, found at OAC 317:55-5-11 and the DBM Contract.

317:55-3-11. ~~Intermediate sanctions~~Cost sharing

~~(a) **Intermediate sanctions obligation.** OHCA will establish intermediate sanctions that it may impose on an MCO if OHCA makes any of the determinations specified in 42 C.F.R. § 438.700(b)-(d).~~

~~(b) **Adoption of intermediate sanctions.** OHCA adopts the intermediate sanctions as provided at 42 C.F.R. § 438.702.~~

~~(c) **Imposition of sanctions.** If OHCA makes a determination per 42 C.F.R. §§ 438.700 or 438.706 and thereby imposes intermediate sanctions as listed at 42 C.F.R. §§ 438.702 or 438.706, OHCA will consider the totality of and follow all relevant regulations at 42 C.F.R. Part 438, Subpart I.~~

~~(d) **Required imposition of temporary management.** In accordance with 42 C.F.R. § 438.706(b), OHCA will impose the intermediate sanction of temporary management, regardless of any other sanction that may be imposed, if OHCA finds that an MCO has repeatedly failed to meet substantive requirements in sections 1903(m) or 1932 of the Act or 42 C.F.R. Part 438. In this situation, OHCA will also grant enrollees the right to terminate enrollment without cause, as described in 42 C.F.R. § 438.702(a)(3), and must notify the affected enrollees of their right to terminate enrollment. Notwithstanding any other Section of these rules, OHCA will not delay imposition of temporary management to provide a hearing before imposing this sanction. OHCA will continue this sanction until the MCO can ensure that the sanctioned behavior will not recur.~~

~~(e) **Retained authority.** OHCA retains authority to impose additional sanctions under State statutes or State regulations that address areas of noncompliance specified in 42 C.F.R. § 438.700, as well as additional areas of noncompliance. Nothing in 42 C.F.R. Part 438, Subpart I, prevents OHCA from exercising that authority.~~

(f) **Notice.** Before imposing an intermediate sanction, OHCA will give the affected MCO timely written notice that explains the basis and nature of the sanction and any other appeal rights that OHCA elects to provide.

(g) **Right to request fair hearing.** Though not required under federal regulation, OHCA provides each MCO the right, upon notice of a sanction other than optional or required temporary management, to request a fair hearing before an administrative law judge (ALJ) retained by OHCA. The cost of actions necessary to process an MCO's request will be paid by OHCA.

(1) An MCO must file any request for fair hearing within thirty (30) days after receiving the notice.

(2) The ALJ has jurisdiction to hear any request under this section. The ALJ will review the appeal for legal authority and jurisdiction. If legal authority and jurisdictional requirements are met, the ALJ will conduct an administrative hearing according to the hearing practices of OAC 317:2-1-5, provide proposed findings of fact and conclusions of law to the parties, and send written notice to the parties of the final order sustaining or denying imposition of the sanction.

(3) At the ALJ's discretion, the ALJ will:

(A) Establish a scheduling order;

(B) Establish reasonable procedures such as authorizing pleadings to be filed by facsimile or electronic mail;

(C) Rule on all interlocutory motions;

(D) Require briefing of any or all issues;

(E) Conduct hearings in a forum and manner as determined by the ALJ;

(F) Rule on the admissibility of all evidence;

(G) Question witnesses;

(H) Impose appropriate sanctions against any person failing to obey an order of the ALJ or authorized under the rules in this section which will include:

(i) Refusing to allow the person to assert or oppose designated claims or defenses, or prohibiting that person from introducing designated matters in evidence;

(ii) Excluding all testimony of an unresponsive or evasive witness; or

(iii) Expelling the person from further participation in the hearing;

(I) Take official notice of any material fact not appearing as evidence in the record, if the fact is among traditional matters of judicial notice;

(J) Administer oaths or affirmations;

(K) Determine the location of the hearing and manner in which it will be conducted;

(L) Allow either party to request that the hearing be recorded by a court reporter with costs to be borne by the requesting party. The original of such transcription, if ordered, will be given to the ALJ with a copy to be given to the requesting party;

(M) Recess and reconvene the hearing;

(N) Set and/or limit the time frame of the hearing;

(O) Make proposed findings of facts and conclusions of law; and

(P) Sustain or deny OHCA's imposition of the sanction(s).

The CE or DBM shall ensure that all Enrollees are held harmless by providers for payment for any existing covered services, other than required cost sharing, during the continuity of care period. The CE or DBM shall not impose premiums or charges on Enrollees that are in excess of those permitted in the SoonerCare program in accordance with OAC 317:30-3-5 and the Oklahoma Medicaid State Plan. If the CE or DBM fails to comply with OAC 317:55-3-11, the OHCA may impose any or all the CE intermediate sanctions, found at OAC 317:55-5-10 and the CE Contract, or DBM administrative remedies, found at OAC 317:55-5-11 and the DBM Contract.

In accordance with Section 1916(e) of the Act, a provider participating in the SoonerSelect

program may not deny care or services to an eligible individual based on such individual's inability to pay the co-payment. An enrollee's assertion of the inability to pay the co-payment establishes this inability.

This rule does not change the fact that a member is liable for these charges, and it does not preclude the provider from attempting to collect the co-payment.

Providers will be required to refund any co-payment amounts the provider collected from the member in error and/or above the family's aggregate cost sharing maximum.

317:55-3-12. Non-compliance damages and remedies Provider contracting and network requirements

If OHCA finds an MCO or DBM to be in violation of the provisions of 56 O.S. §§ 4002-4004, rules promulgated thereto, or the terms and conditions of the contract, OHCA may enforce any damages or remedies for non-compliance as required by CMS, as provided for in the contract, or as permitted by State or Federal law.

(a) **Provider contracts.** A CE or DBM must provide or arrange for the delivery of covered health care services described in OAC 317:55-3-5 through a provider agreement with SoonerCare-contracted providers. All provider agreements must be in writing and in accordance with the Contract and 42 C.F.R. §§ 434.6 and 438.6. The CE's or DBM's execution of a provider agreement does not terminate the CE's or DBM's legal responsibility to the OHCA to ensure all the CE's and DBM's activities and obligations are performed in accordance with Okla. Admin. Code § 317, as applicable, the CE's or DBM's Contract with the OHCA, and all applicable federal, state, and local regulations. The CE or DBM shall maintain, and have available, written policies and procedures on:

- (1) Participating provider selection;
- (2) Retention and termination of a provider's participation with the CE or DBM;
- (3) Responding to changes in the CE'S or DBM'S network of participating providers that affect access and ability to deliver services in a timely manner; and
- (4) Access standards.

(b) **Provider network.**

- (1) The CE and DBM must maintain, in accordance with 42 C.F.R. § 438.206(b)(1), a network of appropriate participating providers that is supported by a signed provider agreement and is sufficient to provide adequate access and availability to all services covered under the Contract with the OHCA, including those with limited English proficiency or physical or mental disabilities.
- (2) The CE and DBM must ensure that all requirements found at 42 C.F.R. § 438.3(q)(1) and (q)(3) are met.
- (3) The CE and DBM must meet and require its participating providers to meet state standards for timely access to care and services, in accordance with 42 C.F.R. § 438.206(c) and all contractual requirements.
- (4) The OHCA shall monitor and review the CE's and DBM's compliance with all standards as part of all ongoing oversight activities.

(c) **Credentialing and recredentialing.**

- (1) All CE and DBM must utilize the same single Credential Verification Organization (CVO) that is certified by a CMS-approved accrediting organization and approved by OHCA as part of its provider credentialing and recredentialing process. The CE and DBM credentialing and recredentialing processes shall comply with relevant state and federal regulations, including, but not limited to, 42 C.F.R. §§ 438.12, 438.206(b)(6), and 438.214, and all applicable contractual requirements.

(2) The CE and DBM must ensure that providers have been properly credentialed to ensure provider facilities, organizations, and staff meet all qualifications and requirements for participation in the Oklahoma Medicaid program. All applications must be credentialed and the CE's or DBM's claim systems must be able to recognize the provider as a SoonerSelect program network provider, within all applicable timeframes as outlined within the Contract with the OHCA.

(3) The recredentialing process must take into consideration provider performance data including Enrollee grievance and appeal, quality of care, and utilization management.

(4) The CE and DBM must review and approve the credentials of all applicable licensed and unlicensed participating and contracted providers who participate in the CE's or DBM's provider network at least once every three (3) years.

(5) If the CE or DBM fails to comply with the credentialing and recredentialing standards per OAC 317:55-5-12(c), the OHCA may impose any or all the CE intermediate sanctions, found at OAC 317:55-5-10 and the CE Contract, or DBM administrative remedies, found at OAC 317:55-5-11 and the DBM Contract.

(d) Non-discrimination against providers.

(1) The CE's and DBM's written policies and procedures shall not discriminate against providers that serve high-risk populations or specialize in conditions that require costly treatment, per 42 C.F.R. §§ 438.12(a)(2) and 438.214(a).

(2) In accordance with 56 O.S. § 4002.4(B), shall not exclude essential community providers, providers who receive directed payments in accordance with 42 C.F.R. Part 438, and such other providers, as directed by OHCA from execution of provider agreements.

317:55-3-13. Termination of managed care contract Time, distance, and access standards

(a) Termination of an MCO, permitted by 42 C.F.R. § 438.708. Members impacted by the contract termination of an MCO will be enrolled with a different MCO or be provided Medicaid benefits through options as prescribed in the Oklahoma Medicaid State Plan. OHCA may terminate a contract with an MCO if OHCA determines that the MCO:

(1) Failed to carry out the substantive terms of the contract; or

(2) Failed to meet applicable requirements of sections 1903(m), 1905(t), or 1932 of the Act.

(b) Termination permitted by contract, MCO or DBM. Grounds for termination include:

(1) Mutual consent. OHCA and the MCO or DBM may terminate the contract by a mutually written agreement. The MCO or DBM does not have the right to appeal the termination. Enrollees impacted by the contract termination will be enrolled with a different MCO or DBM of their choosing or, if no choice is made, a default MCO or DBM.

(2) Termination for convenience. OHCA may terminate a contract for convenience, in whole or part, with a sixty (60) day written notice to the MCO or DBM if the State determines that termination is in the State's best interest. Any partial termination of the contract will not be construed as a waiver of, and will not affect, the rights and obligations of any party regarding portions of the contract that remain in effect. Upon receipt of notice of such termination, the MCO or DBM will immediately comply with the notice terms and take all necessary steps to minimize the incurrence of costs allocable to the work affected by the notice.

(3) Termination for unavailability of funds. OHCA may terminate a contract for lack of the availability of funds with written notice to the managed care. OHCA will give written notice to the MCO or DBM, effective the close of business on the day specified. OHCA is the final authority on the availability of funds, and the MCO or DBM does not have the right to appeal this termination.

(4) Termination for lack of authority. In the event that the State is determined, in whole or

part, to lack Federal or State approval or authority to contract with an MCO or DBM, OHCA may terminate the contract immediately, effective on the close of business on the day specified. The MCO or DBM does not have the right to appeal this termination.

~~(5) **Termination for default.** OHCA may terminate the contract, in whole or in part, whenever the MCO has failed to carry out the terms of the contract or meet the applicable readiness requirements of §§ 1932, 1903(m) or 1905(t) of the Act.~~

~~(6) **Termination for financial instability.** In the event that OHCA, in its sole discretion, deems an MCO or DBM to be financially unstable to the point of threatening the ability of OHCA to obtain the services provided for under this contract, or to conduct business in the normal course, makes a general assignment for the benefit of creditors or suffers or permits the appointment of a receiver for its business or its assets, then OHCA may, at its option, immediately terminate the contract effective on the close of business on the date specified. In the event OHCA elects to terminate the contract under this provision, the MCO or DBM will be notified in writing specifying the date of termination. In the event of the filing of a petition in bankruptcy court by or against a principal subcontractor, the MCO or DBM will immediately advise OHCA. The MCO or DBM will ensure that all tasks related to the subcontract are performed in accordance with the terms of the contract.~~

~~(7) **Termination for debarment.** Section 1932(d)(1) of the Act prohibits affiliations with individuals debarred by federal agencies. The MCO will not knowingly have an individual or affiliate, as defined in Section 1932(d)(1)(C), who has been debarred, suspended, or otherwise excluded from participating in procurement activities under the Federal Acquisition Regulation or from participating in non-procurement activities under regulations issued under Executive Order No. 12549 or under guidelines implementing Executive Order No. 12549.~~

~~(e) **Notice and pre-termination hearing.** Prior to terminating an MCO's contract for default, financial instability, or debarment, OHCA will provide the MCO a pre-termination hearing. OHCA will:~~

~~(1) Give the MCO written notice of the intent to terminate, the reason for termination, and the time and place of the hearing. The notice will detail how the MCO has failed to carry out the terms of the contract and/or failed to comply with the requirements of 1932, 1903(m) and 1905(t) of the Act. A time period will be provided, if applicable, in which the MCO is allowed to cure the default prior to the pre-termination hearing. If the MCO cures the default within the specified timeframe, no further action is required;~~

~~(2) After the hearing, the MCO will receive written notice of the decision affirming or reversing the proposed termination of the contract. In the event the decision is affirmed the notice is to include the effective date of the termination; and~~

~~(3) Upon affirmation of a decision, OHCA will give enrollees of the MCO written notice, comporting with the content requirements of 42 C.F.R. § 438.10, of the termination and information identifying options for receiving Medicaid services following the effective date of termination. This notice will be provided within five (5) business days of the affirming decision.~~

~~(d) **Hearing timing.** Though not required under federal regulation, OHCA provides each MCO the right, upon notice of a termination, to request a fair hearing before an administrative law judge (ALJ) retained by OHCA. The cost of actions necessary to process an MCO's request will be paid by OHCA.~~

~~(1) An MCO will file any request for fair hearing within thirty (30) days after receiving the notice.~~

~~(2) The ALJ has jurisdiction to hear any request under this section. The ALJ will review the appeal for legal authority and jurisdiction. If legal authority and jurisdictional requirements are met, the ALJ will conduct an administrative hearing according to the hearing practices of OAC~~

317:2-1-5, provide proposed findings of fact and conclusions of law to the parties, and send written notice to the parties of the final order sustaining or denying imposition of the sanction.

(3) At the ALJ's discretion, the ALJ will:

- (A) Establish a scheduling order;
- (B) Establish reasonable procedures such as authorizing pleadings to be filed by facsimile or electronic mail;
- (C) Rule on all interlocutory motions;
- (D) Require briefing of any or all issues;
- (E) Conduct hearings in a forum and manner as determined by the ALJ;
- (F) Rule on the admissibility of all evidence;
- (G) Question witnesses;
- (H) Impose appropriate sanctions against any person failing to obey an order of the ALJ or authorized under the rules in this section which will include:
 - (i) Refusing to allow the person to assert or oppose designated claims or defenses, or prohibiting that person from introducing designated matters in evidence;
 - (ii) Excluding all testimony of an unresponsive or evasive witness; or
 - (iii) Expelling the person from further participation in the hearing;
- (I) Take official notice of any material fact not appearing as evidence in the record, if the fact is among traditional matters of judicial notice;
- (J) Administer oaths or affirmations;
- (K) Determine the location of the hearing and manner in which it will be conducted;
- (L) Allow either party to request that the hearing be recorded by a court reporter with costs to be borne by the requesting party. The original of such transcription, if ordered, will be given to the ALJ with a copy to be given to the requesting party;
- (M) Recess and reconvene the hearing;
- (N) Set and/or limit the time frame of the hearing;
- (O) Make proposed findings of facts and conclusions of law; and
- (P) Sustain or deny OHCA's imposition of the termination(s).

(a) The CE and DBM must meet all time and distance standards as established by the OHCA in accordance with 42 C.F.R. § 438.68. The time and distance standards will apply to all geographic areas in which the CE or DBM operates, with standards varying for urban and rural areas, which will include, at a minimum:

- (1) Anticipated enrollment;
- (2) Expected utilization of services;
- (3) Characteristics and health care needs of all covered populations;
- (4) Provider-to-Enrollee ratios;
- (5) Travel time or distance to providers;
- (6) Percentage of contracted providers that are accepting new patients;
- (7) Ability to communicate with limited English proficiency Enrollees;
- (8) Ability to ensure physical access, reasonable accommodations, and accessible equipment for Enrollees with physical or mental disabilities;
- (9) Maximum wait times; and
- (10) Hours of operations.

(b) The standards listed in (a)(1) – (10) of this Section apply to the following medical provider types, in accordance with 42 C.F.R. § 438.68(b) and specified in the Medical and Children's Specialty Program Contract:

- (1) Adult and pediatric PCPs;
- (2) Obstetrics and Gynecology (OB/GYN) providers;

- (3) Adult and pediatric mental health providers;
- (4) Adult and pediatric substance use disorder (SUD) providers;
- (5) Adult and pediatric specialists;
- (6) Hospitals;
- (7) Pharmacies; and
- (8) Essential community providers.

(c) The standards listed in (a)(1) – (10) of this Section apply to the following dental provider types, in accordance with 42 C.F.R § 438.68(b) and specified in the DBM Contract:

- (1) General dentistry providers;
- (2) Pediatric specialty dental providers;
- (3) Specialty dental providers; and
- (4) Essential community providers.

(d) If the CE or DBM fails to comply with the standards as set forth in this Section, the OHCA may impose any or all the CE intermediate sanctions, found at OAC 317:55-5-10 and the CE Contract, or DBM administrative remedies, found at OAC 317:55-5-11 and the DBM Contract.

317:55-3-14. Record retention/Primary care requirements

~~In addition to the requirements found at OAC 317:30-3-15 and 317:30-5-70.2, the MCO or DBM and its affiliates, subcontractors, and employees must retain records in compliance with the provisions and spirit of 42 C.F.R. §§ 438.3(h) and (u), to the extent applicable.~~

(a) Primary care spending/expenses. No later than the end of the fourth (4th) year of the initial contracting period, each CE shall be currently spending not less than eleven percent (11%) of its total health care expenses on primary care services.

(b) Primary care expenditure reporting requirements.

- (1) The CEs must submit a primary care implementation plan which describes the CEs strategies for increasing the percentage of total medical expenditures allocated to primary care over the initial four (4) year contract period.
- (2) The plan shall include target annual percentage increases over the previous year baseline data that demonstrate the CEs ability to achieve eleven percent (11%) by the end of year four (4).

(c) Primary care expenditure calculations.

- (1) CEs shall submit data on an annual basis for primary care and total medical expenditures made through paid claims amounts and non-claims payments to the OHCA, in the manner and timeline prescribed in the SoonerSelect Contract.
- (2) The OHCA will consider non-claims-based investments into primary care including but not limited to investments in electronic health record (EHR) systems, health information exchange (HIE) costs, care coordination activities and systems, and recruitment/retention incentives for primary care providers in rural and medically underserved areas.
- (3) Other non-claims-based investments may be reviewed and approved by the OHCA.
- (4) The OHCA may impose a cap on the amount of non-claims-based investment considered in the primary care expenditure calculation.

317:55-3-15. Provider agreement/contract termination

(a) The CE and DBM and all participating providers have the right to terminate the Contract entered into with each other via a provider agreement.

(b) The CE and DBM and all participating providers may terminate the provider agreement for cause with thirty (30) days advance written notice and without cause with sixty (60) days advance written notice to the other party.

(c) The CE and DBM shall terminate its provider agreement with a participating provider immediately if any of the following circumstances occur:

- (1) In order to protect the health and safety of all Enrollees;
- (2) If a credible allegation of fraud results in a conviction of credible allegation on the participating provider;
- (3) When the participating provider's licenses, certifications and/or accreditations are modified, revoked or in any other way making it unlawful for the provider to provide services under the Contract; or
- (4) If requested by the OHCA.

(d) The OHCA reserves the right to terminate a provider from SoonerCare participation. The OHCA will notify the CE or DBM regarding any termination. The CE and DBM shall be responsible for monitoring all state registries to review any participating providers that are terminated by OHCA and excluded from participation in the CE's or DBM's participating provider network.

317:55-3-16. Non-licensed providers

- (a) The CE and DBM must ensure that all non-licensed providers are educated, trained, and qualified to perform all job responsibilities.
- (b) Background checks and database screening in accordance with state and federal laws must be completed to ensure the non-licensed provider has not been excluded or debarred from participation in Medicare, Medicaid, or any federal health care program.
- (c) All applicable state and federal regulations and contractual requirements must be followed when employing non-licensed providers.

PART 5. REQUIRED FEDERAL AUTHORIZATIONS, GRIEVANCE, APPEAL AND PROVIDER COMPLAINT SYSTEM

317:55-3-20. Authorizations, SoonerSelect enrollee grievance and appeal system

Prior to the implementation of any MCP authorized under 42 C.F.R. Part 438, OHCA will receive the following authorizations:

- (1) Federal authority through a State Plan Amendment or waiver of the Act;
- (2) CMS approval of each contract in relation to the MCP;
- (3) CMS approval of all contract rates authorized under the MCP; and
- (4) CMS approval of direct payment arrangements authorized under the MCP.

(a) The CE or DBM shall have written grievance and appeal policies and procedures for an Enrollee, or an Enrollee's authorized representative, to appeal a CE's or DBM's action and/or file a grievance. The policies must address contractual requirements, including performance standards, and federal funding requirements, including 42 C.F.R. § 438 Subpart F and OAC 317:2-3-3.

- (1) Timeframes, pursuant to OAC 317:2-3-2;
- (2) Grievances, pursuant to OAC 317:2-3-4;
- (3) Appeals, pursuant to OAC 317:2-3-5;
- (4) Grievance and appeal notices, pursuant to OAC 317:2-3-8;
- (5) State fair hearings, pursuant to OAC 317:2-3-12;
- (6) Recordkeeping, pursuant to OAC 317:2-3-11; and
- (7) Continuation of benefits, pursuant to OAC 317:2-1-2.6 and 317:2-3-5.1.

(b) If the CE or DBM fails to meet performance standards, the OHCA may impose any or all the CE intermediate sanctions, found at OAC 317:55-5-10 and the CE Contract, or DBM administrative remedies, found at OAC 317:55-5-11 and the DBM Contract.

317:55-3-21. Timing Provider complaint system

~~OHCA may only execute transition to a managed care delivery system ninety (90) days after CMS has approved all contracts entered into between OHCA and all MCOs or DBMs following OHCA's submission of readiness review results to CMS, pursuant to 42 C.F.R. § 438.66.~~

The CE or DBM shall have written provider complaint policies and procedures for an Enrollee, or an Enrollee's authorized representative, to appeal a CE's or DBM's action and/or file a grievance. The policies must address contractual requirements, including performance standards, and federal funding requirements, including 42 C.F.R. Part 438 Subpart F and OAC 317:2-3-10.

- (1) Timeframes, pursuant to OAC 317:2-3-2;
- (2) Notices, pursuant to OAC 317:2-3-8; and
- (3) Recordkeeping, pursuant to OAC 317:2-3-11.

SUBCHAPTER 5. REQUIREMENTS FOR MANAGED CARE ORGANIZATIONS CONTRACTED ENTITIES AND DENTAL BENEFITS MANAGERS

PART 1. ACCREDITATION AND READINESS MONITORING, PROGRAM INTEGRITY, DATA, AND REPORTING

317:55-5-1. MCO or DBM accreditation Monitoring system for all SoonerSelect programs

~~All MCOs and DBMs will be accredited in accordance with 45 C.F.R. § 165.275 by an accrediting entity recognized by the United States Department of Health and Human Services.~~

(a) In accordance with 42 C.F.R. § 438.66, the OHCA will monitor each CE or DBM to assess its ability and capacity to comply with program and Contract-specific requirements and to assess its ability to perform satisfactorily in all major operational areas.

(b) The CE or DBM shall have a reporting monitoring process for ensuring compliance with all Contract requirements, implementation deadlines for mandates and/or laws as directed by CMS, CDC, or other federal or state government entity. The CE or DBM shall report monthly on its compliance monitoring activities as required by the reporting manual.

317:55-5-2. MCO or DBM readiness Program integrity; data and reporting

~~(a) According to 42 C.F.R. § 438.66, during implementation and prior to enrollment effective dates, the MCO or DBM will participate in a readiness review process. To be deemed eligible to effect enrollments, the MCO or DBM will complete all readiness review activities to the satisfaction of OHCA and CMS. The readiness reviews will be conducted through one (1) or more desk reviews and one or more on-site reviews. The MCO or DBM must satisfactorily demonstrate readiness for MCP operations, including but not limited to focus areas identified at 42 C.F.R. § 438.66(b). At any stage(s) of the readiness review process, OHCA may but is not required to provide an MCO or DBM with notice(s) of deficiency and reasonable opportunity(ies) to cure the deficiency. As between the parties to the managed care contract, OHCA has sole authority to determine the readiness of any MCO or DBM.~~

~~(b) As a part of any readiness review, OHCA will ensure the MCO or DBM meets the requirements at 56 O.S. § 4002.10.~~

(a) **Program integrity standards.** The CE and DBM shall comply with all state and federal laws, regulations, and mandates including but not limited to 42 C.F.R. § 438.608. The CE and DBM shall have and implement written policies and procedures that are designed to detect and prevent fraud, waste, and abuse pursuant to the Contract and federal regulations. The CE and DBM shall:

- (1) Provide a monthly report (by close of the last calendar day of each month), of all open Program Integrity related audits and investigations related to fraud, waste, and abuse activities

for identifying and collecting potential overpayments, utilization review, and provider compliance.

(2) Refer credible allegations of fraud to OHCA's Legal Division in writing within three (3) business days of discovery.

(3) Suspend all payments to the provider when a credible allegation of fraud exists.

(4) Participate in good faith at monthly Program Integrity meetings held jointly with MFCU and OHCA.

(5) Participate in good faith at monthly meetings with OHCA Program Integrity and Accountability Unit.

(6) Disclose any change in ownership and control information to OHCA within thirty-five (35) calendar days.

(7) Submit to OHCA or HHS, within thirty-five (35) days of request, full and complete information about:

(A) The ownership of any subcontractor with whom the CE/DBM has had business transactions totaling more than twenty-five thousand dollars (\$25,000) during the twelve (12-month) period ending on the date of the request; and

(B) Any significant business transactions between the CE/DBM and any wholly owned supplier, or between the provider and any subcontractor, during the five (5-year) period ending on the date of request.

(b) Data and reporting standards.

(1) The CE and DBM shall:

(A) Provide information responsive to specific requests made by OHCA, MFCU, or other authorized state and federal authorities (including, but not limited to, requests for records of Health Plan Enrollee and provider interviews), within three (3) business days of said request, unless otherwise agreed upon by OHCA.

(B) Submit weekly encounter data by the deadline established by OHCA and in accordance with OHCA accuracy standards.

(C) Submit a required report timely and/or accurately.

(2) The CE or DBM shall not falsify or misrepresent information that it furnishes to CMS or OHCA.

(c) Request for information. The CE or DBM shall provide and prioritize requests for information made by OHCA, MFCU, or other authorized state and federal authorities. The CE or DBM shall respond to urgent requests from OHCA within twenty-four hours (24-hours) and according to guidance and timelines provided by OHCA.

(d) Record retention. The CE or DBM shall retain records for a period of ten (10) years as well as comply with all state and federal regulations and contractual requirements.

(e) Non-compliance actions. If the CE or DBM fails to submit any OHCA-requested materials, as specified in this Section, without cause as determined by OHCA, on or before the due date, OHCA may impose any or all the CE sanctions, found at OAC 317:55-5-10 and the CE Contract, or DBM administrative penalties, found at OAC 317:55-5-11 and the DBM Contract.

317:55-5-3. Critical incident reporting system

(a) The CE shall ensure that any serious incident that harms or potentially harms the Enrollee's health, safety, or well-being, including incidents of seclusion and restraint, are immediately identified, reported, reviewed, investigated, and corrected, in compliance with state and federal law.

(b) When the Enrollee is in the care of a behavioral health inpatient, PRTF, or crisis stabilization unit, critical incidents shall include, but are not limited to the following:

(1) Suicide death;

- (2) Non-suicide death;
 - (3) Death-cause unknown;
 - (4) Homicide;
 - (5) Homicide attempt with significant medical intervention;
 - (6) Suicide attempt with significant medical intervention;
 - (7) Allegation of physical, sexual, or verbal abuse or neglect;
 - (8) Accidental injury with significant medical intervention;
 - (9) Use of restraints/seclusion (isolation);
 - (10) AWOL or absence from a mental health facility without permission; or
 - (11) Treatment complications (medication errors and adverse medication reaction) requiring significant medical intervention.
- (c) The CE shall develop and implement a critical incident reporting and tracking system for behavioral health adverse or critical incidents and shall require participating providers to report adverse or critical incidents to the CE, OHS, and the Enrollee's parent or legal guardian.
- (d) Participating providers shall contact the CE by phone no later than 5:00pm Central time on the business day following a serious occurrence and disclose, at a minimum:
- (1) The name of the Enrollee involved in the serious incident;
 - (2) A description of the occurrence; and
 - (3) The name, street address, and telephone number of the facility.
- (e) The participating provider must, within three (3) days of the serious occurrence, submit a written facility critical incident report to the CE.
- (1) The facility critical incident report must include specific information regarding the incident including the following:
 - (A) All information listed in OAC 317:55-5-3 (d)(1) through (3);
 - (B) Available follow-up information regarding the Enrollee's condition;
 - (C) Debriefings; and
 - (D) Any programmatic changes that were implemented.
 - (2) A copy of this report must be maintained in the Enrollee's record, along with the names of the persons at the CE and OHS to whom the occurrence was reported.
 - (3) A copy of the report must also be maintained in the incident and accident report logs kept by the facility.
 - (4) The CE shall review the participating provider's report and follow up with the participating provider as necessary to ensure that an appropriate investigation was conducted, and corrective actions were implemented within applicable timeframes.
- (f) The CE shall provide appropriate training and take corrective action as needed to ensure its staff and participating providers, as applicable, comply with all critical incident requirements, in the manner and format outlined in the reporting manual.

PART 3. PROVIDER REQUIREMENTS NON-COMPLIANCE OF A CE AND/OR DBM AND NOTIFICATIONS

317:55-5-10. Provider contracts and credentialing standards Non-compliance of contracted entities

- (a) All MCOs and DBMs will formally credential and recredential network providers at a frequency required by a single, consolidated provider enrollment and credentialing process established by OHCA in accordance with 42 C.F.R. § 438.214 and in coordination with MCOs and DBMs.
- (b) All MCOs and DBMs will contract to the extent possible and practicable with all essential community providers who receive directed payments in accordance with 42 C.F.R. Part 438 and any

other providers as specified by OHCA through contract.

(e) Every MCO and DBM will contract with every participating provider through a written provider agreement that:

(1) Identifies the contractual obligations between the MCO or DBM and the participating provider; and

(2) Incorporates any provision required by the contract between OHCA and the MCO or DBM for inclusion in the provider agreement.

(d) An MCO or DBM or any subcontractor thereof will not enforce with any provider a policy or contract term that requires the provider to contract for all products currently offered or that may be offered in the future by the MCO, DBM, or subcontractor.

(a) Failure to comply. If the CE fails to fulfill its duties and obligations or meet performance standards under 42 C.F.R. Part 438, 42 U.S.C. § 1396b(m), 42 U.S.C. § 1396u-2, Title 317 of the Oklahoma Administrative Code, or the CE Contract, OHCA will notify the CE of unmet performance expectations, violations or deficiencies, and may impose corrective actions or any sanctions in addition to or instead of any actions or sanctions specified in the Contract.

(b) Non-material compliance deficiencies.

(1) If OHCA determines that unmet performance expectations, violations, or deficiencies do not result in a material deficiency or delay in the implementation or operation of services, the CE will have five (5) business days (or the date specified by OHCA) of receipt of notice to provide the OHCA with a written response that:

(A) Explains the reasons for the deficiency;

(B) The CE's plan to address or cure the deficiency; and

(C) The date and time by which the deficiency will be cured.

(D) If the CE disagrees with OHCA's findings, the CE shall provide its reasons for disagreeing with OHCA's findings.

(2) The CE's proposed cure of a non-material deficiency is subject to the approval of OHCA.

(3) The CE's repeated commission of non-material deficiencies or repeated failure to resolve any such deficiencies may be regarded by OHCA as a material deficiency and entitle OHCA to pursue any other remedy provided in the Contract or any other appropriate remedy OHCA may have at law or equity.

(c) Material compliance deficiencies.

(1) An item of material non compliance means a specific action of the CE that:

(A) Violates a substantive term of the Contract;

(B) Fails to meet an agreed upon measure of performance; or

(C) Represents a failure of the CE to be reasonably responsive to a reasonable request of OHCA relating to the Services for information, assistance, or support within the timeframe specified by OHCA.

(2) If OHCA determines that unmet performance expectations, violations, or deficiencies result in a material deficiency, The CE may be required to submit a written CAP under the signature of the CE's CEO to correct or resolve a material breach of the Contract.

(A) The CAP must:

(i) Be submitted by the deadline set forth in the OHCA's request for a CAP.

(ii) Be reviewed and approved by the OHCA.

(B) Following the approval of the CAP, the OHCA may:

(i) Condition such approval on completion of tasks in the order or priority that the OHCA prescribes;

(ii) Disapprove portions of the CE's proposed CAP; or

(iii) Require additional or different corrective action(s) or timelines/time limits.

- (C) The CE remains responsible for achieving the established performance criteria.
- (3) OHCA may apply one (1) or more of the following non-compliance remedies for each item of material non-compliance listed in (2) of this Section.
- (A) Conduct accelerated monitoring of the CE;
- (B) Require additional, more detailed, financial and/or programmatic reports to be submitted by the CE;
- (C) Decline to renew or extend the Contract;
- (D) Require forfeiture of all or part of the CE's performance bond or other substitute; or
- (E) Terminate the Contract in accordance with OAC 317:55-5-14.
- (4) In addition to the non-compliance remedies, the OHCA may impose tailored remedies, including liquidated damages pursuant to (e) of this Section.
- (d) Imposition of intermediate sanctions.** In accordance with 42 C.F.R. § 438.702, if OHCA determines the CE is non-compliant and 42 C.F.R. § 438.700(b) is the basis for the Agency's determination, OHCA may impose the following intermediate sanctions:
- (1) Imposition of civil money penalties in the amounts specified in 42 C.F.R. § 438.704;
- (2) Grant Enrollee(s) the right to terminate enrollment without cause and notifying the affected Enrollees of their right to disenroll;
- (3) Suspend all new enrollment of Enrollee(s), including default enrollment, after the date OHCA notifies the CE of a determination of a violation of any requirement under § 1903(m) or § 1932 of The Act;
- (4) Suspend or recoup capitation payments to the CE for Enrollees enrolled after the effective date of the sanction and until OHCA is satisfied that the reason for imposition of the sanction no longer exist and is not likely to recur;
- (5) Impose additional sanctions provided for under state statutes or regulations to address noncompliance in accordance with 42 C.F.R. § 438.702(b); and
- (6) Appoint temporary management in accordance with 42 C.F.R. § 438.706. The CE shall comply with the contractual requirements found in Section 1.26.3.5 "Intermediate Sanctions" of the Contract.
- (7) The CE shall be responsible for all reasonable expenses related to the direct operation of the SoonerSelect program, including but not limited to attorney fees, cost of preliminary or other audits of the CE and expenses related to the management of any office or other assets of the CE.
- (e) Liquidated damages.** OHCA may impose actual, consequential, and liquidated damages in accordance with Tit. 23 O.S. § 21, resulting from the CE's failure to comply with any of the terms of the Contract, Ch. 55, or any applicable state or federal regulations. Consequential and liquidated damages will be assessed if OHCA determines such failure is the fault of the CE, including the CE's subcontractors and/or consultants, and is not materially caused or contributed to by OHCA or its agents.
- (f) Other provisions.** The CE shall be responsible for all reasonable expenses related to the direct operation of the SoonerSelect Medical program, including but not limited to attorney fees, cost of preliminary or other audits of the CE and expenses related to the management of any office or other assets of the CE.

317:55-5-11. Network adequacy standards~~Non-compliance of dental benefit managers~~

~~In accordance with 42 C.F.R. § 438.604, the MCO or DBM will submit documentation for which OHCA will base its certification to CMS that the MCO or DBM has complied with requirements for availability and accessibility of services, including health professional shortage areas and adequacy of the MCO's or DBM's network, as set forth in 42 C.F.R. §§ 438.206, 438.14 and 438.68.~~

(a) Failure to comply. If the DBM fails to fulfill its duties and obligations or meet performance standards under 42 C.F.R. Part 438, 42 U.S.C. § 1396b(m), 42 U.S.C. § 1396u-2, Title 317 of the Oklahoma Administrative Code, or the DBM Contract, OHCA will notify the DBM of unmet performance expectations, violations, or deficiencies, and may impose corrective actions or any sanctions in addition to or instead of any actions or sanctions specified in the Contract.

(b) Non-material compliance deficiencies.

(1) If OHCA determines that unmet performance expectations, violations, or deficiencies do not result in a material deficiency or delay in the implementation or operation of services, the DBM will have five (5) business days (or the date specified by OHCA) of receipt of notice to provide the OHCA with a written response that:

(A) Explains the reasons for the deficiency;

(B) The DBM's plan to address or cure the deficiency; and

(C) The date and time by which the deficiency will be cured; or

(D) If the DBM disagrees with OHCA's findings, the DBM shall provide its reasons for disagreeing with OHCA's findings.

(2) The DBM's proposed cure of a non-material deficiency is subject to the approval of OHCA.

(3) The DBM's repeated commission of non-material deficiencies or repeated failure to resolve any such deficiencies may be regarded by OHCA as a material deficiency and entitle OHCA to pursue any other remedy provided in the Contract or any other appropriate remedy OHCA may have at law or equity.

(c) Material compliance deficiencies.

(1) An item of material non compliance means a specific action of the DBM that:

(A) Violates a substantive term of the Contract;

(B) Fails to meet an agreed upon measure of performance; or

(C) Represents a failure of the DBM to be reasonably responsive to a reasonable request of OHCA relating to the services for information, assistance, or support within the timeframe specified by OHCA.

(2) If OHCA determines that unmet performance expectations, violations, or deficiencies result in a material deficiency, the DBM may be required to submit a written CAP under the signature of the DBM's CEO to correct or resolve a material breach of the Contract.

(A) The CAP must:

(i) Be submitted by the deadline set forth in OHCA's request for a CAP.

(ii) Be reviewed and approved by OHCA.

(B) Following the approval of the CAP, the OHCA may:

(i) Condition such approval on completion of tasks in the order or priority that the OHCA prescribes;

(ii) Disapprove portions of the DBM's proposed CAP; or

(iii) Require additional or different corrective action(s) or timelines/time limits.

(C) The DBM remains responsible for achieving the established performance criteria.

(3) OHCA may apply one (1) or more of the administrative remedies found in (f) of this Section for each item of material non-compliance listed in (c)(2) of this Section.

(d) Liquidated damages. OHCA may impose actual, consequential, and liquidated damages in accordance with 23 O.S. § 21, resulting from the DBM's failure to comply with any of the terms of the Contract, Ch. 55, or any applicable state or federal regulations. Consequential and liquidated damages will be assessed if OHCA determines such failure is the fault of the DBM, including the CE's subcontractors and/or consultants, and is not materially caused or contributed to by OHCA or its agents.

(e) Administrative remedies. OHCA may impose the following remedies:

- (1) Conduct accelerated monitoring of the DBM;
- (2) Require additional, more detailed, financial and/or programmatic reports to be submitted by the DBM;
- (3) Decline to renew or extend the Contract;
- (4) Require forfeiture of all or part of the DBM's performance bond or other substitute; or
- (5) Terminate the Contract in accordance with OAC 317:55-5-14.
- (6) Grant Enrollee(s) the right to terminate enrollment without cause and notifying the affected Enrollees of their right to disenroll;
- (7) Suspend all new enrollment of Enrollee(s), including default enrollment, after the date OHCA notifies the CE or DBM of a determination of a violation of any requirement;
- (8) Suspend or recoup capitation payments to the DBM for Enrollees enrolled after the effective date of the sanction and until OHCA is satisfied that the reason for imposition of the sanction no longer exist and is not likely to recur; and
- (9) Appoint temporary management in accordance with 42 C.F.R. § 438.706. The DBM shall comply with the contractual requirements found in the Contract at Section 1.26.3.5 "Imposition of Liquidated Damages".

(f) **Other provisions.** The DBM shall be responsible for all reasonable expenses related to the direct operation of the SoonerSelect Dental program, including but not limited to attorney fees, cost of preliminary or other audits of the DBM and expenses related to the management of any office or other assets of the DBM.

317:55-5-12. Prior authorization requirements, generallyTermination of contract

~~The OHCA will establish prior authorization requirements that are consistent with 56 O.S. §§ 4002-4004. MCOs and DBMs may establish prior authorization of benefits to the extent these are consistent with OHCA's policies and rules. The MCO or DBM may propose to impose additional prior authorization requirements, subject to OHCA's review and approval, except for those benefits identified in the Oklahoma Medicaid State Plan, rules, or practices as exempt from prior authorization. The MCO or DBM may be less restrictive on the requirements of a prior authorization than OHCA but may not impose greater restrictions.~~

(a) The Contract may be terminated prior to its scheduled expiration date only for the reasons specified in this Section.

- (1) **Termination for mutual consent.** OHCA and the CE or DBM may terminate the contract by mutual written agreement.
- (2) **Termination for convenience.** The OHCA may terminate the contract, in whole or in part, for convenience if it is determined that termination is in the state's best interest.
- (3) **Termination for default.** OHCA may, at its election, assign Enrollees to another DBM/CE or provide benefits through other State Plan authority if the DBM/CE has breached this contract and is unable or unwilling to cure such breach within the period of time as specified in writing by OHCA.
- (4) **Termination for unavailability of funds.** If state, federal, or other funding is not sufficiently appropriated, or is withdrawn, reduced, or limited in any way after the effective date of the contract, OHCA may terminate this contract immediately, effective on the close of business on the day specified. OHCA shall be the final authority as to the availability of funds.
- (5) **Termination for lack of authority.** If any necessary federal or state approval or authority to operate the SoonerSelect Medical or Dental program is not granted, or the Oklahoma Legislature prohibits OHCA from contracting with a CE or DBM for the provision of health care for Eligibles or Enrollees, OHCA may terminate this contract immediately, effective on the close of business on the day specified.

(6) Termination for financial instability. If the OHCA deems, in its sole discretion, that the CE or DBM is financially unstable to the point of threatening the ability of OHCA to obtain the services provided for under this contract, ceases to conduct business in the normal course, makes a general assignment for the benefit of creditors or suffers or permits the appointment of a receiver for its business or its assets, then OHCA may, at its option, immediately terminate this Contract effective on the close of business on the date specified.

(7) Termination for debarment. The CE or DBM will not knowingly have a relationship with an individual or affiliate, as defined in 42 C.F.R. § 438.610.

(b) Transition period requirements. A transition period begins upon notification by the OHCA of intent to terminate the contract, notice by the CE or DBM or OHCA of intent not to extend the contract for a subsequent extension period, or if the CE or DBM has no remaining extension periods.

317:55-5-13. Notification of material change

An ~~MCOA~~ CE or DBM will promptly, within one (1) business day, notify OHCA of all changes materially affecting the delivery of care or the administration of the ~~MCP~~ plan.

317:55-5-14. Patient data

An ~~MCOA~~ CE or DBM will provide patient data to a provider upon request to the extent allowed under federal or ~~State~~ state laws, rules, or regulations, including but not limited to the Health Insurance Portability and Accountability Act of 1996.

PART 5. FINANCE

317:55-5-20. ~~Capitation rates~~ Financial standards and third-party liability

OHCA will contract with an actuary, as defined at 42 C.F.R. § 438.2, to establish actuarially sound capitation rates, as described at 42 C.F.R. §§ 438.3(e), 438.4, and 438.5, for OHCA to pay to ~~MCOs and DBMs.~~

(a) Financial standards. The CE or DBM shall comply with Oklahoma Insurance Department requirements for minimum net worth and risk-based capital in accordance with applicable Oklahoma Statutes found in Title 36 Insurance.

(b) Insolvency protection. In accordance with the requirements found at 42 C.F.R. §§ 438.106, 438.116, 36 O.S. § 6901, et seq., and all contractual requirements, the CE and DBM will provide satisfactory assurances to the OHCA to ensure that neither Enrollees nor the OHCA is held liable or responsible for any of the following:

(1) Any debts obtained by the CE or DBM;

(2) Covered services that are provided to the Enrollee for which the OHCA does not pay the CE or DBM; or

(3) Payment for covered services that are in excess of the amount that the Enrollee would owe the CE or DBM if those services were covered directly.

(c) Medical loss ratio. A CE or DBM will have a medical loss ratio that, at minimum, meets the standards provided by 42 C.F.R. §§ 438.8, 438.74, and applicable Contract. OHCA will monitor compliance with this requirement. If CE or DBM are not compliant with submission of MLR reporting, OHCA will evaluate the CE's or DBM's status for penalties or termination. Monitoring procedures to ensure compliance with MLR reporting include review of timeliness and completeness of reporting requirement and audit of data contained within the report.

(d) Third-party liability. Medicaid should be the payer of last resort for all covered services pursuant to federal regulations including but not limited to 42 C.F.R. 433 Subpart D and 42 C.F.R. § 447.20. The OHCA will notify the CE and DBM for any known third-party resources identified or

made available to OHCA at the time of an Applicant's or Eligible's eligibility determination or re-determination. The CE or DBM shall make every reasonable effort to:

- (1) Determine the liability of third parties to pay for services rendered to Enrollees;
- (2) Avoid costs which may be the responsibility of third parties;
- (3) Reduce payments based on payments by a third-party for any part of a service;
- (4) Recover any liability from responsible third-party sources, except for estate recovery and third-party subrogation which will remain OHCA's responsibility;
- (5) Treat funds recovered from third parties as reductions to claims payments as required in the Contract; and
- (6) Report all third-party liability collections as specified by the OHCA, the Contract, and reporting manual.

317:55-5-21. Medical loss ratio Payment to CEs and DBMs

An MCO or DBM will have a medical loss ratio that, at minimum, meets the standards provided by 42 C.F.R. § 438.8.

(a) **Capitation rates.** In consideration for all services rendered by a CE or DBM under a contract with the OHCA, the CE and DBM will receive a monthly capitation payment for each Enrollee pursuant to 42 C.F.R. §§ 438.3(c), 438.4 and any other applicable state and/or federal regulation.

(b) **Capitation reconciliation.** The CE and DBM shall perform monthly reconciliation of enrollment roster data against capitation payments and notify discrepancies to the OHCA on schedule and as defined by the OHCA.

(c) **Denial of payment.** Capitation payments to the CE or DBM will be denied for new Enrollees when, and for so long as, payment for those Enrollees is denied by CMS under 42 C.F.R. § 438.730(e). CMS may deny payment to OHCA for new Enrollees if its determination is not contested timely by the CE. OHCA will define in writing to the CE the conditions for lifting the payment denials.

(d) **Recoupment for Medicare eligible Enrollees.** In the event an Enrollee becomes retroactively Medicare eligible, the CE or DBM shall recover claims payments made to providers during the months of retroactive Medicare eligibility. The CE or DBM shall also notify the provider of the requirement to submit the claim to Medicare for reimbursement. OHCA will recoup the capitation payments paid for months of retroactive Medicare eligibility.

317:55-5-22. Value-based purchasing Payment to providers

In any contract for managed care services, OHCA may include provisions in which payments OHCA makes to an MCO or DBM are based in whole or in part on quality measures and/or any other performance metric as defined in the contract.

(a) Provider payment.

(1) The CE and DBM shall establish rates for participating providers that are reasonable to cover access to services.

(2) The CE and DBM shall abide by state and federal requirements related to payment of specific provider types as described in the Contract.

(3) Pursuant to 56 O.S. § 4002.12, the OHCA shall establish minimum rates of reimbursement from CEs to providers who elect not to enter into a value-based payment arrangement or other alternative payment arrangements for health care services rendered to Enrollees.

(4) Applicable exceptions to OAC 317:55-5-22(3) can be found at 56 O.S. § 4002.12(I).

(b) **Non-participating provider payment.** If the CE or DBM is unable to provide covered services to an Enrollee within its network of participating providers, the CE or DBM must adequately and timely arrange for the provision and payment of these services by non-participating providers.

Except as otherwise provided by law and/or specified for IHCPs, FQHCs, RHCs, and CCBHs, the CE or DBM will reimburse non-participating providers for covered services provided to Enrollees at a minimum of ninety percent (90%) of the current Medicaid fee schedule, unless the CE or DBM and the non-participating provider has agreed to a different reimbursement amount.

(c) **Value-based payments.** The CE and DBM shall implement value-based payment strategies and quality improvement initiatives to promote better care, better health outcomes, and lower spending for publicly funded health care services. OHCA will follow the withhold payment schedule and perform annual assessments to ensure CEs and DBMs are adhering to the VBP target requirements in accordance with the Contract. Pursuant to 42 C.F.R. § 438.10(f)(3), if the CE uses physician financial incentive plans, the Contractor must make available information about the incentive program. The CE shall also provide information about any physician incentive plans to OHCA prior to its initial use and prior to any subsequent revisions, and report information to OHCA as specified in the reporting manual. Any such incentive plans must comply with all applicable laws, including, without limitation 42 U.S.C. § 1395mm(i)(8) and 42 C.F.R § 417.479.

317:55-5-23. ~~Special contract provisions related to payment~~ Timely claims filing and processing

(a) **Federal regulation.** Any special contract provision related to payment, as described at 42 C.F.R. § 438.6, will meet all related standards within the federal regulation.

(b) **Provider payments.**

(1) OHCA will establish minimum rates of reimbursement paid by MCOs and DBPs to providers who choose not to enter into value-based payment arrangements for health care items and services furnished by such providers to enrollees.

(A) For participating providers, the reimbursement rate until July 1, 2026, will be equal to or greater than one hundred percent (100%) of the reimbursement rate for the applicable item or service per the applicable OHCA fee schedule.

(B) For non-participating providers and subject to CMS approval as a directed payment or otherwise, the reimbursement rate, until July 1, 2026, will be equal to or greater than ninety percent (90%) of the reimbursement rate for the applicable item or service provided by a non-participating provider per the applicable OHCA fee schedule as of January 1, 2021.

(2) Notwithstanding any other provision of this section, OHCA will comply with payment methodologies required by federal law or regulation for specific types of providers including, but not limited to, Federally Qualified Health Centers (FQHCs), rural health clinics (RHCs), pharmacies, Indian Health Care Providers (IHCPs), and emergency services.

(c) **Optional value-based payments.** The MCO or DBM will offer optional value-based payment arrangements to all providers. Reimbursement amounts to providers in value-based payment arrangements align with the quality measures OHCA applies to MCOs or DBMs, respectively.

(a) **Timely claims filing.** The CE or DBM shall adjudicate provider claims in accordance with timely filing limits specified in OAC 317:30-3-11.

(b) **Timely payment.** The CE or DBM shall meet timely claims payment standards specified in the Contract and 42 C.F.R § 447.45.

317:55-5-24. Hospital readmission damages

The OHCA will establish a hospital readmission damage program to reduce potentially preventable readmissions. The program will use a nationally recognized tool to establish a base measurement year and a performance year and will provide for risk-adjustment based on the population of the state Medicaid program covered by the ~~MCOs or DBMs~~ CEs. The program will be

fully described in the ~~managed care contract~~ Contract so that the program will be founded on contract-current tools, populations, and other factors.

317:55-5-25. Claims processing and methodology; post payment audits

(a) **Claims payment systems.** The MCOCE or DBM will maintain a claims payment system capable of processing and adjudicating claims for payment in an accurate and timely manner and in full compliance with all ~~State and Federal~~ state and federal laws.

(b) **Claim filing.** A claim that is filed by a provider within six (6) months of the date the item or service was furnished will be considered timely, per ~~Oklahoma Administrative Code (OAC)~~ OAC 317:30-3-11.

(c) **Clean claims.** The MCOCE or DBM will process a clean claim within the time frame outlined in 36 O.S. § 1219.

(1) The MCOCE or DBM will ensure that at least ninety percent (90%) of clean claims received from all providers are paid within fourteen (14) days of receipt.

(2) A clean claim that is not processed within the time frame will bear simple interest at the monthly rate of one and one-half percent (1.5%), which is payable to the provider.

(d) **Additional documentation.** After a claim has been paid but not prior to payment, the MCOCE or DBM may request medical records; if additional documentation is needed to review the claim for medical necessity.

(e) **Claim denials.**

(1) A claim denial will include the following information:

(A) Detailed explanation of the basis for the denial; and

(B) Detailed description of the additional information necessary to substantiate the claim.

(2) The MCOCE or DBM will establish a process for all claim denials by which the provider may identify and provide additional information to substantiate the claim.

(3) A provider will have six (6) months from the receipt of a claim denial to file an appeal per OAC 317:2-3-10.

(f) **Post payment audits.**

(1) In accordance with OAC 317:30-5-70.2, the MCOCE or DBM will comply with the post payment audit process established by OHCA.

(2) The MCOCE or DBM will adhere to limits set forth by OHCA regarding the percentage of claims that can be subjected to post payment audits.

(3) ~~An MCOA CE~~ A MCOCE or DBM who has a claims denial error rate of greater than five percent (5%) will be subject to damages as set forth by OHCA in the ~~managed care contract~~ Contract.

317:55-5-26. Prohibited payments

(a) **Overpayment.** The CE or DBM shall report overpayments to OHCA and promptly recover identified overpayments.

(b) **Suspension of payments.** The CE or DBM shall suspend payments to providers for which the state determines there is a credible allegation of fraud in accordance with the Contract and 42 C.F.R. § 455.23.

(c) **Providers ineligible for payment.** The CE or DBM shall ensure that no Medicaid funds are reimbursed to a provider whose payments are suspended or that has been terminated by the OHCA.

(d) **Provider-preventable conditions.** In accordance with 42 C.F.R. §§ 438.3(g), 434.6(a)(12)(i) and 447.26(b), the CE or DBM shall not make any payment to a provider for provider-preventable conditions as defined at 42 C.F.R. § 447.26(b). A list of provider-preventable conditions including health care-acquired conditions (HCACs) and other provider-preventable conditions (OPPCs) for which payment shall not be made can be found at OAC 317:30-3-62 and 30-3-63.

**PART 7. THE ~~MANAGED CARE~~SOONERSELECT QUALITY ADVISORY
COMMITTEE**

317:55-5-30. ~~Managed care~~SoonerSelect quality advisory committee

(a) The Chief Executive Officer (CEO) of OHCA will establish and appoint members to the ~~MCS~~SoonerSelect Quality Advisory Committee (Committee). Committee members serve without compensation and at the pleasure of the CEO. The Committee will consist of:

- (1) Participating providers as a majority of the Committee members;
- (2) Representatives of hospitals and health systems;
- (3) Members of the health care community; and
- (4) Members of the academic community with an expertise in health care or other applicable field.

(b) The primary power and duty of the Committee is set forth at 56 O.S. § 4002.13.

(c) Committee meetings will be subject to the Oklahoma Open Meeting Act.

(d) The Committee will select from among its membership a chair and vice chair.

(e) The Committee may meet as often as may be required ~~in order~~ to perform the duties imposed on it.

(f) A quorum of the Committee will be required to approve any final ~~action~~recommendations of the Committee. A majority of the members of the Committee will constitute a quorum.

317:55-5-31. Quality scorecard

(a) Within one (1) year of beginning steady state operations of any ~~MCP~~plan, OHCA will create a quality scorecard, in accordance with 56 O.S. § 4002.11, that compares ~~MCOs~~CEs to one another and DBMs to one another.

(b) OHCA will provide the most recent quarterly scorecard for ~~initial enrollees~~first time Enrollees during choice counseling.

(c) OHCA will provide the most recent quarterly scorecard to all ~~enrollees~~Enrollees at the beginning of each open enrollment period.

(d) OHCA will publish each quarterly scorecard on its website.

**TITLE 317. OKLAHOMA HEALTH CARE AUTHORITY
CHAPTER 35. MEDICAL ASSISTANCE FOR ADULTS AND CHILDREN-
ELIGIBILITY**

SUBCHAPTER 7. MEDICAL SERVICES

PART 7. CERTIFICATION, REDETERMINATION AND NOTIFICATION

317:35-7-61.1. Special redetermination procedures for Tax Equity and Fiscal Responsibility Act (TEFRA)

In addition to redetermining the level of care ~~annually~~, the OHCA also conducts an annual cost effectiveness review for all active TEFRA children. If OHCA determines the child does not meet any level of care, is no longer disabled, or the estimated cost of care in the home is greater than the estimated cost of care in an institution, at the appropriate level of care, the case is closed.

**SUBCHAPTER 9. ICF/IID, HCBW/IID, AND INDIVIDUALS AGE 65 OR OLDER IN
MENTAL HEALTH HOSPITALS**

**PART 5. DETERMINATION OF MEDICAL ELIGIBILITY FOR ICF/IID, HCBW/IID,
AND INDIVIDUALS AGE 65 OR OLDER IN MENTAL HEALTH HOSPITALS**

317:35-9-48.1. Determining ICF/IID institutional level of care for TEFRA children

In order to determine ~~ICF/IID~~ Intermediate Care Facility for Individuals with Intellectual Disabilities (ICF/IID) level of care for ~~TEFRA~~ Tax Equity and Fiscal Responsibility Act (TEFRA) children:

(1) The child must be age ~~18~~ eighteen (18) years or younger and expected to meet the following criteria for at least ~~30~~ thirty (30) days.

(A) Applicants under age three (3) must:

- (i) ~~have~~ Have a diagnosis of a developmental disability; and
- (ii) ~~have~~ Have been evaluated by the SoonerStart Early Intervention Program or other appropriate healthcare provider, and found to have severe ~~dysfunctional~~ deficiencies with findings of at least two (2) standard deviations in at least two (2) total domain areas.

(B) Applicants age three (3) years and older must:

- (i) ~~have~~ Have a diagnosis of intellectual disability or a developmental disability; and
- (ii) ~~have~~ Have received a psychological evaluation by a licensed psychologist, ~~or~~ school psychologist certified by the Oklahoma Department of Education (ODE) within the last ~~12~~ twelve (12) months, certified psychometrist, psychological technician of a psychologist, or licensed behavioral health professional (LBHP). The evaluation must include intelligence testing that yields a full-scale intelligence quotient, as determined appropriate by the provider, and a full-scale functional or adaptive assessment that yields a composite functional age. Eligibility for TEFRA ICF/IID level of institutional care requires either an IQ of 70 ~~70~~ seventy (70) or less, or a full-scale functional assessment indicating a functional age composite that does not exceed fifty (50) percent of the child's chronological age. In no case shall eligibility be granted for a functional age greater than eight (8) years.

(2) Psychological evaluations are required for children who are approved for TEFRA under ICF/IID level of care. Children under evaluation, including both intelligence testing and adaptive/functional assessment, by a licensed psychologist, ~~or school psychologist certified by the ODE, certified psychometrist, psychological technician of a psychologist, or licensed behavioral health professional (LBHP)~~ at age three, age six, application, at two (2) years (but no later than three (3) years) after the initial psychological evaluation, and at two (2) years (but no later than three (3) years) after the second psychological evaluation and, if medically necessary, thereafter, to ascertain continued eligibility for TEFRA under the ICF/IID level of institutional care. ~~The psychological evaluation must be completed and submitted to the LOCEU no later than 90 days following the child's third (3rd) and sixth (6th) birthday, and, if medically necessary, thereafter.~~

DRAFT

**TITLE 317. OKLAHOMA HEALTH CARE AUTHORITY
CHAPTER 30. MEDICAL PROVIDERS-FEE FOR SERVICE**

SUBCHAPTER 3. GENERAL PROVIDER POLICIES

PART 1. GENERAL SCOPE AND ADMINISTRATION

317:30-3-5. Assignment and cost sharing

(a) **Definitions.** The following words and terms, when used in subsection (c) of this Section, shall have the following meaning, unless the context clearly indicates otherwise:

(1) **"Fee-for-service (FFS) contract"** means the provider agreement specified in Oklahoma Administrative Code (OAC) 317:30-3-2. This contract is ~~the contract~~ between the Oklahoma Health Care Authority (OHCA) and medical providers which provides for a fee with a specified service involved.

(2) **"Outside of the scope of the services"** means all medical benefits outside the set of services defined at OAC 317:25-7 and the provisions of the SoonerCare Choice contracts in the SoonerCare program.

(3) **"Within the scope of services"** means the set of covered services defined at OAC 317:25-7 and the provisions of the SoonerCare Choice contracts in the SoonerCare program

(b) **Assignment in FFS.** Oklahoma's Medicaid State Plan provides that participation in the medical program is limited to providers who accept, as payment in full, the amounts paid by OHCA plus any deductible, coinsurance, or co-payment required by the State Plan to be paid by the member and make no additional charges to the member or others.

(1) OHCA presumes acceptance of assignment upon receipt of an assigned claim. This assignment, once made, cannot be rescinded, in whole or in part by one party, without the consent of the other party.

(2) Once an assigned claim has been filed, the member must not be billed, and the member is not responsible for any balance except the amount indicated by OHCA. The only amount a member may be responsible for is a co-payment, or the member may be responsible for services not covered under the medical programs. In any event, the member should not be billed for charges on an assigned claim until the claim has been adjudicated or other notice of action received by the provider. Any questions regarding amounts paid should be directed to OHCA, Provider Services.

(3) When potential assignment violations are detected, the OHCA will contact the provider to assure that all provisions of the assignment agreement are understood. When there are repeated or uncorrected violations of the assignment agreement, the OHCA is required to suspend further payment to the provider.

(c) **Assignment in SoonerCare.** Any provider who holds a FFS contract and also executes a contract with a provider in the SoonerCare Choice program must adhere to the rules of this subsection regarding assignment.

(1) If the service provided to the member is outside of the scope of the services outlined in the SoonerCare contract, then the provider may bill or seek collection from the member.

(2) In the event there is a disagreement whether the services are in or out of the scope of the contracts referenced in (1) of this subsection, the OHCA shall be the final authority for this decision.

(3) Violation of this provision shall be grounds for a contract termination in the FFS and SoonerCare programs.

(d) **Cost sharing/co-payment.** Section 1902(a)(14) of the Social Security Act permits states to require certain members to share some of the costs of SoonerCare by imposing upon them such payments as enrollment fees, premiums, deductibles, coinsurance, co-payments, or similar cost sharing charges. OHCA requires a co-payment of some SoonerCare members for certain medical services provided through the FFS program. A co-payment is a charge which must be paid by the member to the service provider when the service is covered by SoonerCare. Section 1916(e) of the Act requires that a provider participating in the SoonerCare program may not deny care or services to an eligible individual based on such individual's inability to pay the co-payment. A person's assertion of their inability to pay the co-payment establishes this inability. This rule does not change the fact that a member is liable for these charges, and it does not preclude the provider from attempting to collect the co-payment.

- (1) Co-payment is not required of the following members:
 - (A) Individuals under age twenty-one (21). Each member's date of birth is available on the REVS system or through a commercial swipe card system.
 - (B) Members in nursing facilities (NF) and intermediate care facilities for individuals with intellectual disabilities (ICF/IID).
 - (C) Home and Community-Based Services (HCBS) waiver members except for prescription drugs.
 - (D) American Indian and Alaska Native members, per Section 5006 of the American Recovery and Reinvestment Act of 2009 and as established in the federally-approved Oklahoma Medicaid State Plan.
 - (E) Individuals who are categorically eligible for SoonerCare through the Breast and Cervical Cancer Treatment program.
 - (F) Individuals receiving hospice care, as defined in section 1905(o) of the Social Security Act.
- (2) Co-payment is not required for the following services:
 - (A) Family planning services. This includes all contraceptives and services rendered.
 - (B) Emergency services provided in a hospital, clinic, office, or other facility.
 - (C) Services furnished to pregnant women.
 - (D) Smoking and tobacco cessation counseling and products.
 - (E) Blood glucose testing supplies and insulin syringes.
 - (F) Medication-assisted treatment (MAT) drugs.
 - (G) Vaccine administration.
 - (H) Preventive services for expansion adults.
 - (I) Opioid overdose reversal agents.
- (3) Co-payments are required in an amount not to exceed the federal allowable for the following:
 - (A) Inpatient hospital stays.
 - (B) Outpatient hospital visits.
 - (C) Ambulatory surgery visits including free-standing ambulatory surgery centers.
 - (D) Encounters with the following rendering providers:
 - (i) Physicians;
 - (ii) Advanced practice registered nurses;
 - (iii) Physician assistants;
 - (iv) Optometrists;
 - (v) Home health agencies;
 - (vi) Certified registered nurse anesthetists;

- (vii) Anesthesiologist assistants;
- (viii) Durable medical equipment providers; and
- (ix) Outpatient behavioral health providers.

(E) Prescription drugs.

(F) Crossover claims. Dually eligible Medicare/SoonerCare members must make a co-payment in an amount that does not exceed the federal allowable per visit/encounter for all Part B covered services. This does not include dually eligible HCBS waiver members.

(4) Medicaid premiums and cost sharing incurred by all individuals in the Medicaid household may not exceed an aggregate limit of five percent (5%) of the family's income applied on a monthly basis, as specified by the agency.

(5) Providers will be required to refund any co-payment amounts the provider collected from the member in error and/or above the family's aggregate cost sharing maximum.

DRAFT

This page intentionally left blank

**TITLE 317. OKLAHOMA HEALTH CARE AUTHORITY
CHAPTER 35. MEDICAL ASSISTANCE FOR ADULTS AND CHILDREN-
ELIGIBILITY**

317:35-16-1. State Plan Personal Care Services (SPPC)

(a) The State Plan Personal Care services described in this subchapter are available to the following:

- (1) Expansion adults;
- (2) TEFRA children; and
- (3) Certain MAGI populations (children) who qualify under the EPSDT program.

(b) SPPC services assist a member in carrying out Activities of Daily Living (ADLs) or Instrumental Activities of Daily Living (IADLs) directly related to the member's personal care needs. SPPC services prevent or minimize physical health regression or deterioration. SPPC services require a skilled nursing assessment to:

- (1) Assess a member's needs;
- (2) Develop a care plan to meet the member's identified personal care needs;
- (3) Manage care plan oversight; and
- (4) Periodically reassess and update the care plan when necessary.

(c) SPPC services do not include technical services, such as:

- (1) Suctioning;
- (2) Tracheal care;
- (3) Gastrostomy-tube feeding or care;
- (4) Specialized feeding due to choking risk;
- (5) Applying compression stockings;
- (6) Bladder catheterization;
- (7) Colostomy irrigation;
- (8) Wound care;
- (9) Applying prescription lotions or topical ointments;
- (10) Range of motion exercises; or
- (11) Operating equipment of technical nature, such as a patient lift or oxygen equipment.

(d) SPPC members may receive services in limited types of living arrangements as per (1) through (5) of this subsection.

(1) SPPC members are not eligible to receive services while residing in an institutional setting including, but not limited to:

(A) Licensed facilities, such as a:

- (i) Hospital;
- (ii) Nursing facility;
- (iii) Licensed residential care facility; or
- (iv) Licensed assisted living facility; or

(B) In an unlicensed institutional living arrangement, such as a room and board home or facility.

(2) SPPC is not approved when the member lives in the personal care assistant's (PCA) home, except with approval of the OHCA supervisor overseeing SPPC. For approval, a clinical evaluation of the household composition must be conducted and reviewed. The clinical evaluation shall include, but is not limited to, the following:

(A) Informal supports available;

(B) All legal obligations of the household member, including the individual who is a legally responsible family member such as a spouse, legal guardian, or parent of a minor child as defined per OAC 317:35-16-7(3);

(C) Urgency of the services; and

(D) Any other factors that may arise warranting approval as determined by the OHCA Supervisor.

(3) Members may receive SPPC services in the member's own home, apartment, or a family member's or friend's home or apartment. A home or apartment unit is defined as a self-contained living space having a lockable entrance to the unit including a bathroom and food storage and preparation amenities in addition to bedroom and living space.

(4) For SPPC members who are full-time students, a dormitory room qualifies as an allowable living arrangement to receive SPPC services.

(5) With prior approval from an OHCA supervisor overseeing SPPC, services may be provided in an educational or employment setting to assist the member to achieve vocational goals identified in the care plan.

(e) SPPC services eligibility is contingent on a member requiring one (1) or more of the services offered at least monthly including personal care, meal preparation, housekeeping, laundry, shopping or errands, or specified special tasks to meet ADL or IADL assessed needs.

317:35-16-2. Determination of medical eligibility for State Plan Personal Care (SPPC) services for Expansion Adults, TEFRA, and certain MAGI populations

(a) Eligibility. The OHCA Clinical Review team (OHCA nurse) determines medical eligibility for SPPC services based on the Uniform Comprehensive Assessment Tool (UCAT) Part III and the determination that the member has unmet care needs that require personal care assistance. SPPC services are initiated to support the regular care provided in the member's home. SPPC services are not intended to take the place of regular care, general maintenance tasks, or meal preparation provided by natural supports, such as spouses or other adults who live in the same household. Additionally, SPPC services are not furnished when they principally benefit the family unit. To be eligible for SPPC services, the applicant:

(1) Has adequate informal supports. This means there is adult supervision that is present or available to contribute to care, or decision-making ability, as documented on the UCAT Part III. To remain in his or her home without risk to his or her health, safety, and well-being, the applicant:

(A) Must have the decision-making ability to respond appropriately to situations that jeopardize his or her health and safety, or has available supports that compensate for his or her lack of ability as documented on the UCAT Part III; or

(B) His or her decision-making ability, lacks the physical capacity to respond appropriately to situations that jeopardize health and safety, and an OHCA nurse has informed his/her of potential risks and consequences of remaining in the home.

(2) Requires a care plan for planning and administering services delivered under a professional personnel's supervision;

(3) Has a physical impairment or combination of physical and mental impairments as documented on the UCAT Part III. An applicant who poses a threat to himself or herself or others, as supported by professional or credible documentation, may not be approved for SPPC services. An individual who is actively psychotic or believed to be in danger of potential harm to himself or herself or others may not be approved;

(4) Does not have household members or persons who routinely visit the household who, as supported by professional or credible documentation, pose a threat of harm or injury to the applicant or other household visitors;

(5) Lacks the ability to meet personal care needs without additional supervision or assistance, or to communicate needs to others; and

(6) Requires assistance, not of a technical nature, to prevent or minimize physical health regression and deterioration.

(b) **Definitions.** The following words and terms, when used in this subsection, shall have the following meaning, unless the context clearly indicates otherwise:

(1) "**Activities of Daily Living**" (ADL) means activities that reflect the applicant's or member's ability to perform self-care tasks essential for sustaining health and safety, such as:

(A) Bathing;

(B) Eating;

(C) Dressing;

(D) Grooming;

(E) Transferring, including activities such as getting in and out of a tub or moving from bed to chair;

(F) Mobility;

(G) Toileting; and

(H) Bowel or bladder control.

(2) "**ADLs score of three (3) or greater**" means the applicant or member cannot do at least one (1) ADL at all or needs some help with two (2) or more ADLs.

(3) "**Applicant or Member support very low**" means the applicant's or member's UCAT Part III Support score is zero (0), this indicates, in the UCAT Part III assessor's clinical judgment, the formal and informal sources are sufficient for the applicant's or member's present need level in most functional areas.

(4) "**Applicant or Member support low**" means the member's UCAT Part III Support score is five (5), this indicates, in the UCAT Part III assessor's clinical judgment, the support from formal and informal sources are nearly sufficient for the applicant's or member's present need level in most functional areas. The applicant or member, family, or informal supports are meeting most needs typically expected of family or household members to share or do for one another, such as general household maintenance. There is little risk of institutional placement with loss of current supports.

(5) "**Applicant or Member support moderate**" means the UCAT Part III applicant or member score is fifteen (15), this indicates, in the UCAT Part III assessor's clinical judgment, the formal and informal support is available, but overall, it is inadequate, changing, fragile, or otherwise problematic. The applicant or member requires additional assistance that usually includes personal care assistance with one (1) or more ADLs not available through Medicare, the Veterans Administration, or other federal entitlement programs. Informal caregiver support is considered questionable or unreliable due to one (1) or more criteria in (A) through (D) of this paragraph:

(A) Care or support is required continuously with no relief or backup available;

(B) Informal support lacks continuity due to conflicting responsibilities such as work or child care;

(C) Persons with advanced age or disability provide care; or

(D) Institutional placement can reasonably be expected with any loss of existing support.

(6) "Applicant or Member support high" means the applicant or member score is twenty-five (25) this indicates, in the UCAT Part III assessor's clinical judgment, the formal and informal supports are not sufficient as there is very little or no support available to meet the applicant's or member's high degree of need.

(7) "Community Services Worker" means any non-licensed health professional employed by or under contract with a community services provider who provides, for compensation or as a volunteer, health-related services, training, or supportive assistance to frail elderly, disabled person(s), or person(s) with developmental disabilities.

(8) "Community Services Worker Registry" means a registry established by the OKDHS per Section (§) 1025.1 of Title 56 of the Oklahoma Statutes (O.S.) to list community services workers who have a final investigative finding of abuse, neglect, or exploitation, per 43A O.S. § 10-103, involving a frail elderly, disabled person(s), or person(s) with developmental disabilities was made by OKDHS or an administrative law judge; and amended in 2002, to include the listing of SoonerCare (Medicaid) personal care assistants (PCAs) providing personal care services.

(9) "Instrumental Activities of Daily Living (IADL)" means those daily activities that reflect the applicant or member's ability to perform household chores and tasks within the community essential for sustaining health and safety, such as:

- (A) Shopping;
- (B) Cooking;
- (C) Cleaning;
- (D) Managing money;
- (E) Using a phone;
- (F) Doing laundry;
- (G) Taking medication; and
- (H) Accessing transportation.

(10) "IADLs score is at least six (6)" means the applicant or member needs some help with at least three (3) IADLs or cannot do two (2) IADLs at all.

(11) "IADLs score of eight (8) or greater" means the applicant or member needs some help with at least four (4) IADLs or the member cannot do two (2) IADLs at all and needs some help with one (1) or more other IADLs.

(12) "MSQ" means the Mental Status Questionnaire.

(13) "MSQ moderate risk range" means a total weighted-score of seven (7) to eleven (11) that indicates an orientation-memory-concentration impairment or memory impairment.

(14) "Nutrition moderate risk" means a total weighted UCAT Part III Nutrition score is eight (8) or greater that indicates poor appetite or weight loss combined with special diet requirements, medications, or difficulties in eating.

(15) "Social Resource score is eight (8) or more" means the applicant or member lives alone, has no informal support when he or she is sick or needs assistance, or has little or no contact with others.

(c) Medical eligibility minimum criteria for SPPC. The medical eligibility minimum criteria for SPPC services are the minimum UCAT score criteria that an applicant or member meets for medical eligibility and are:

- (1) ADLs score is five (5) or greater; or has an IADLs score of eight (8) or greater; or Nutrition score is (8) or greater; or the MSQ score is seven (7) or greater; or the ADLs score is three (3) and IADLs score is at least six (6); and

(2) Applicant or Member Support score is fifteen (15) or more; or Applicant or Member Support score is five (5) and the Social Resources score is eight (8) or greater.

(d) **Medical eligibility determination.** Medical eligibility for personal care is determined by the OHCA. The medical decision for personal care is made by the OHCA supervisor, overseeing SPPC services, utilizing the UCAT Part III. The member will be notified prior to UCAT III assessment that the result could indicate a need for disability review.

(1) Referrals will be made to the OKDHS if the applicant requires a disability review based on information obtained in referral and/or UCAT Part III.

(2) Upon receipt of the referral the OHCA nurse is responsible for completing the UCAT Part III assessment visit within ten (10) business days of the personal care application for the applicant who is SoonerCare eligible at the time of the request. The OHCA nurse completes the assessment visit within twenty (20) business days of the referral for the applicant not determined SoonerCare eligible at the time of the request. When the application indicates the request is from an individual who resides at home and an immediate response is required to ensure the applicant's health and safety, to prevent an emergency situation, or to avoid institutional placement, the UCAT Part III assessment visit has top-scheduling priority.

(3) During the assessment visit, the OHCA nurse completes the UCAT III and reviews rights to privacy, fair hearing, provider choice, and the pre-service acknowledgement agreement with the member. The OHCA nurse informs the applicant of medical eligibility criteria and provides information about OHCA long-term care service options. The OHCA nurse documents if the member wants to be considered for nursing facility level of care services or if the member is applying for a specific service program on the UCAT Part III. When, based on the information obtained during the assessment, the OHCA nurse determines if the member may be at risk for health and safety, an immediate referral is made to Adult Protective Services or Child Protective Services, as applicable. The referral is documented on the UCAT Part III.

(A) When the applicant's needs cannot be met by personal care services alone, the OHCA nurse provides information about other community long-term care service options. The OHCA nurse assists in accessing service options the applicant or member selects in addition to, or in place of, SPPC services.

(B) When multiple household members are applying for SoonerCare SPPC services, the UCAT Part III assessment is done for all the household members at the same time.

(C) The OHCA nurse provides the applicant or member with information about the qualified agencies in his or her local area that provide services and obtains the applicant's or member's primary and secondary agency choice. When the applicant or family declines to choose a primary personal care service agency, the round-robin rotation system is used for agency selection. The OHCA nurse documents the selected personal care provider agency's name.

(4) The OHCA nurse completes the UCAT Part III and sends it to an alternate OHCA nurse for medical eligibility determination. SPPC services eligibility is established on the date medical eligibility is approved and financial eligibility is established. This date serves as the certification date for services to be initiated.

(A) When the time length from the initial assessment to the date of service eligibility determination exceeds ninety (90) calendar days, a new UCAT Part III assessment is required.

(B) The OHCA nurse assigns a medical certification period of not more than thirty-six (36) months for persons eighteen (18) years of age and older or not more than twelve (12)

months for persons younger than eighteen (18) years of age. The service plan period is for twelve (12) months and is provided by the OHCA nurse.

(5) Upon establishing SPPC certification, the OHCA nurse notifies the applicant's or member's preferred provider agency, or when necessary, the secondary provider agency or the provider agency selected by the round robin rotation system. Within one (1) business day of provider agency acceptance, the OHCA nurse submits the information via electronic system to the provider agency for plan development. Refer to OAC 317:35-15-8(a).

(6) Following the provider agency's SPPC plan development, and within three (3) business days of receipt from the provider agency, the OHCA nurse reviews the documentation to ensure agreement with the plan. Once agreement is established, the plan is submitted to OHCA Personal Care Supervisor for review and then the plan is authorized.

(7) Within one (1) business day of knowledge of the authorization, the OHCA nurse submits the plan authorization to the provider agency via electronic system.

317:35-16-3. Certification for State Plan Personal Care

(a) **State Plan Personal Care (SPPC) certification period.** The first month of the SPPC certification period is the first month the member is determined financially and medically eligible for SPPC. When eligibility or ineligibility for SPPC is established, OHCA updates the computer-generated notice and the appropriate notice is mailed to the member.

(b) **Financial certification period.** The financial certification period for SPPC services is twelve (12) months. Eligibility redetermination is completed according to the categorical relationship.

(c) **Medical certification period.** A medical certification period of not more than thirty-six (36) months is assigned for a member who is approved for SPPC. The certification period for SPPC services is based on the Uniform Comprehensive Assessment Tool evaluation and clinical judgment of the OHCA nurse.

317:35-16-4. Agency State Plan Personal Care (SPPC) service authorization and monitoring

(a) Within ten (10) business days of referral receipt for SPPC services, the personal care provider agency nurse completes an assessment of the member's personal care service needs and completes and submits a person-centered plan based on the member's needs to the OHCA nurse. The plan includes the:

- (1) Adv/SPPC-Nurse Evaluation;
- (2) SPPC-Service Planning; and
- (3) SPPC Member Service Agreement.

(b) When more than one (1) person in the household is referred to receive SPPC or ADvantage services, all household members' plans are discussed and developed with the eligible members so service delivery is coordinated to achieve the most efficient use of resources. The number of SPPC service units authorized for each individual is distributed between all eligible family members. This ensures one (1) family member's absence does not adversely affect the family member(s) remaining in the home. When one (1) or more persons in the same household with a SPPC member is referred to or receives other formal services, such as ADvantage or Developmental Disability Services, then those services are coordinated as well.

(c) The personal care provider agency receives documentation from the OHCA nurse for authorization to begin services. The agency provides a copy of the plan to the member upon initiating services.

(d) Prior to the provider agency placing a Personal Care Assistant (PCA) in the member's home or

other service-delivery setting, an Oklahoma State Bureau of Investigation background check, an Oklahoma State Department of Health Registry check, and an OKDHS Community Services Worker Registry check is completed per Sections 1-1944 through 1-1948 of Title 63 of the Oklahoma Statutes. Payment is made for PCAs who provide SPPC services and meet criteria Oklahoma Administrative Code (OAC) 317:35-15-2(c) (1) through (8).

(e) The provider agency nurse monitors the member's care plan.

(1) The personal care provider agency nurse or staff contacts the member within five (5) business days of authorized document receipt in order to ensure services are implemented according to the authorized care plan.

(2) The provider agency nurse makes a monitoring visit using the Adv/SPPC Nurse Evaluation at least every six (6) months to assess the member's satisfaction with his or her care and to evaluate the care plan for adequacy of goals and authorized units. Whenever a monitoring visit is made, the provider agency nurse documents findings in the electronic system. The provider agency submits monitoring documentation to OHCA nurse for review within five (5) business days of the visit. A registered nurse (RN) conducts the monitoring visit when the PCA is performing hands-on personal care. A licensed practical nurse may only conduct the monitoring visit when the PCA is not performing hands-on personal care. An RN also co-signs the progress notes.

(3) The provider agency nurse's requests to change the number of authorized units in the SPPC plan are submitted via the electronic system to the OHCA nurse to approve or deny prior to changed number of authorized units implementation.

(4) Annually, or more frequently when the member's needs change, the provider agency nurse re-assesses the member's needs and develops a new plan to meet the member's needs. The provider agency nurse completes and submits the annual reassessment documents to the OHCA nurse no sooner than sixty (60) calendar days before the existing service plan end-date, and no later than fourteen (14) calendar days prior to service.

(5) When the member is unstaffed, the provider agency nurse or staff communicates with the member and makes efforts to re-staff. When consecutively unstaffed for seven (7) calendar days, or fewer depending on the member's needs, the provider agency nurse or staff contacts the unstaffed member weekly by phone to actively monitor the member's health and safety and documents ongoing efforts to provide staff using the electronic system. When the member is unstaffed for thirty (30) days, the provider agency notifies the OHCA nurse. The OHCA nurse contacts the member and when the member chooses, initiates a member transfer to another provider agency that can provide staff.

317:35-16-5. Agency State Plan Personal Care services; billing, and problem resolution

The ADvantage Administration (AA) certifies qualified personal care provider agencies and facilitates the execution of the agencies' SoonerCare (Medicaid) contracts on the Oklahoma Health Care Authority's (OHCA) behalf. OHCA checks the list of providers barred from Medicare/SoonerCare (Medicaid) participation to ensure that the personal care services agency is not listed.

(1) **Payment for State Plan Personal Care (SPPC).** Payment for SPPC services is made for care provided in the member's own home or in other limited living arrangement types, per Oklahoma Administrative Code (OAC) 317:35-15-2(b) (1 through 4).

(A) **Provider agency use.** To provide SPPC services, an agency must be licensed by the Oklahoma State Department of Health, meets certification standards identified by

Oklahoma Human Services (OKDHS), and possesses a current SoonerCare (Medicaid) contract.

(B) Reimbursement. SPPC services payment on a member's behalf is made according to the service type and number of authorized service units.

(i) The amount paid to provider agencies for each service unit is determined according to established SoonerCare (Medicaid) rates for the personal care services. Only authorized units contained in each eligible member's individual plan are eligible for reimbursement. Provider agencies serving more than one member residing in the same residence ensure the members' plans combine units in the most efficient manner to meet the needs of all eligible persons in the residence.

(ii) SPPC services payment is for tasks performed in accordance with the authorized care plan per OAC 317:30-5-951. Payment for personal care skilled nursing service is made on the member's behalf for assessment, evaluation, and associated service planning per nursing visit.

(iii) SPPC service time is documented through Electronic Visit Verification System (EVV), previously known as Interactive Voice Response Authentication (IVRA) system, when services are provided in the home.

(2) Issue resolution.

(A) The provider agency provides a written copy of their grievance process to each member at service commencement. The written grievance process includes the name and phone number of a provider agency contact person who is responsible for responding to such complaints and grievances. When the member is dissatisfied with the SPPC provider agency or the assigned PCA and has exhausted attempts to work with the agency's grievance process without resolution, the member is referred to the OHCA team to attempt to resolve the issue(s). The member has the right to appeal to OHCA per OAC 317:2-1-2.

(B) When a PCA performance issue is identified, provider agency staff conducts a counseling conference with the member or the PCA as appropriate. Provider agency staff counsels the PCA regarding problems with his or her performance.

(3) Persons ineligible to serve as a PCA. Payment from SoonerCare funds for SPPC services may not be made to an individual who is a legally responsible family member of the member, such as a spouse, legal guardian, or parent of a minor child, when he or she is providing SPPC services.

317:35-16-6. Financial eligibility redetermination for State Plan Personal Care

The OHCA nurse reviews the electronic system to confirm member eligibility before the end of the certification period. A notice is generated only if there is a change affecting the member's financial eligibility.

317:35-16-7. Medical eligibility redetermination for State Plan Personal Care (SPPC) services

(a) Medical eligibility redetermination. The OHCA nurse completes a medical redetermination before the end of the SPPC certification period.

(b) Recertification. The OHCA nurse re-assesses the SPPC service members eighteen (18) years of age and older, for medical re-certification based on the member's needs and level of caregiver support required, using the Uniform Comprehensive Assessment Tool (UCAT) at least every

thirty-six (36) months. Members younger than eighteen (18) years of age, are re-evaluated by the OHCA nurse using the UCAT on a twelve (12) month basis or sooner when needed. During this re-certification assessment, the OHCA nurse informs the member of the state's other SoonerCare (Medicaid) long-term care options. The OHCA nurse submits the re-assessment to the OHCA nurse for recertification. Documentation is sent to the OHCA nurse no later than the tenth (10th) calendar day of the month certification expires. When the OHCA nurse determines medical eligibility for SPPC services, a recertification review date is entered on the system.

(c) Change in amount of units or tasks. When the SPPC provider agency determines a need for a change in the amount of units or tasks in the service, a care plan is completed and submitted to the OHCA nurse within five (5) business days of identifying the assessed need. The OHCA nurse approves or denies the change prior to implementation.

(d) SPPC services voluntary closure. When a SPPC member decides personal care services are no longer needed to meet his or her needs, a medical decision is not needed. The member is sent a Voluntary Withdrawal Request for confirmation and signature, and the request is entered into the electronic system upon receipt. A closure notification is submitted to the provider agency.

(e) Resuming personal care services. When a SPPC member approved for SPPC services is without services for less than ninety (90) calendar days, but the member has current medical and SoonerCare (Medicaid) financial eligibility approval, SPPC services may be resumed using the member's previously approved care plan. The personal care provider agency nurse contacts the member to determine when changes in health or service needs occurred. When changes are identified, the provider agency nurse completes an assessment visit and submits a SPPC services skilled nursing need re-assessment within ten (10) business days of the resumed plan start date. When the member's needs dictate, the personal care provider agency may submit a request for a change in authorized SPPC service units. When no changes occur, the OHCA agency nurse documents the contact in the electronic system for the OHCA ten (10) business days of the resumed plan start date.

(f) Financial ineligibility. When the OHCA nurse determines the member has lost SoonerCare eligibility, they notify the member of the determination and his or her right to appeal the decision in writing. A closure notification is also submitted to the provider agency.

(g) Closure due to medical ineligibility. When the OHCA determines a member to be medically ineligible for SPPC services, they notify the member of the determination, and his or her right to appeal the decision, in writing. When medical eligibility redetermination is not made prior to current medical eligibility expiration, the existing medical eligibility certification is automatically extended until care level redetermination is established. For members:

(1) Who are not hospitalized or in an extended medical care facility, the existing medical eligibility certification is extended for a maximum sixty (60) calendar days from the date of the previous medical eligibility expiration date;

(2) Who are hospitalized or in an extended medical care facility, the existing medical eligibility certification is extended for thirty (30) calendar days from the date of discharge from the facility or for sixty (60) calendar days from the date of previous medical eligibility expiration date, whichever is longer;

(3) Whose medical eligibility redetermination is not made by applicable extended deadline, the member is determined to be medically ineligible; or

(4) Who no longer meet medical eligibility or cannot be located to complete the redetermination assessment, the OHCA nurse notifies the OHCA personal care supervisor. The OHCA personal care supervisor updates the system's medical eligibility end date and

notifies the OHCA nurse of effective end date. A closure notification is submitted to the provider agency.

(h) State Plan Personal Care services termination.

(1) State Plan Personal Care (SPPC) services may be discontinued when:

(A) Professional documentation supports the member poses a threat to self or others;

(B) Other household members or persons who routinely visit the household who, as professional or credible documentation supports, pose a threat to the member or other household visitors;

(C) The member or the other household members use threatening, intimidating, degrading, or sexually inappropriate language or innuendo or behavior towards service providers, either in the home or through other contact or communications. Efforts to correct such behavior are unsuccessful as professional or credible documentation supports;

(D) The member or family member fails to cooperate with SPPC service delivery or to comply with Oklahoma Health Care Authority (OHCA) or OKDHS rules as professional or credible documentation supports;

(E) The member's health or safety is at risk as professional or credible documentation supports;

(F) Additional services, either "formal" such as, paid by Sooner Care (Medicaid) or some other funding source or "informal" such as, unpaid are provided in the home. This eliminates the need for SoonerCare SPPC services;

(G) The member's living environment poses a physical threat to self or others as professional or credible documentation supports, and measures to correct hazardous conditions or assist the person to move are unsuccessful or are not feasible; or

(H) The member refuses to select or accept a provider agency or Personal Care Assistant (PCA) service for ninety (90) consecutive days as professional or credible documentation supports.

(2) For members receiving SPPC services, the provider agency submits documentation with the recommendation to discontinue services to the OHCA. The OHCA nurse reviews the documentation and submits it to the OHCA personal care supervisor for determination. The personal care provider agency or PCA is notified of the decision to terminate services via the electronic system. The member is sent an official closure notice informing him or her of appropriate member rights to appeal the decision to discontinue services.

317:35-16-8. Case changes

(a) Any time there are changes affecting the State Plan Personal Care case eligibility, computer generated notices are issued.

(b) A member has the right to withdraw their request for SPPC services at any time during the process, but if the member is determined to meet eligibility under another aid category based on information available to the agency during this time (as referenced under 317:35-6-60.1), we are required to take action on this regardless of the withdrawal of the request for SPPC services.

317:35-16-9. Billing procedures for State Plan Personal Care

Billing procedures for State Plan Personal Care (SPPC) services are contained in the Oklahoma Medicaid Management Information Systems (OKMMIS) Billing and Procedure Manual. Questions regarding billing procedures that cannot be resolved through studying the

manual are referred to the Oklahoma Health Care Authority (OHCA). SPPC contractors bill on CMS-1500 claim form. The contracted provider submits a claim for each member. The contracted provider prepares claims for services provided and submits the claims to the fiscal agent responsible for ensuring claims are properly completed. All personal care contractors must have a unique provider number. New contracted providers are mailed the provider number after being placed on the claims processing contractor's provider file. All services provided in the member's home, including Personal Care and Nursing, and all work completed in the provider's office, are documented through the Electronic Visit Verification (EVV) system. The EVV system provides alternate backup solutions if the automated system is unavailable; however, in the event of an EVV system failure, the provider documents time in accordance with internal provider agency policy and procedures backup plan. This documentation is sufficient to account for both in-home and in-office services. The provider agency's backup procedures are only permitted when the EVV system is unavailable.

317:35-16-10. Social services referral

In many situations, members receiving medical services through SoonerCare (Medicaid) need social services. If a member, who is eligible for State Plan Personal Care Services through this Subchapter, has a need for social services, the OHCA will process those necessary referrals.

This page intentionally left blank

**TITLE 317. OKLAHOMA HEALTH CARE AUTHORITY
CHAPTER 45. INSURE OKLAHOMA**

SUBCHAPTER 5. INSURE OKLAHOMA QUALIFIED BENEFIT PLANS

317:45-5-1. Qualified Benefit Plan requirements

(a) Participating qualified benefit plans must offer, at a minimum, benefits that include:

- (1) ~~hospital~~Hospital services;
- (2) ~~physician~~Physician services;
- (3) ~~clinical~~Clinical laboratory and radiology;
- (4) ~~pharmacy~~Pharmacy;
- (5) ~~office~~Visits;
- (6) ~~well~~Well baby/well child exams;
- (7) ~~age~~Age appropriate immunizations as required by law; and
- (8) ~~emergency~~Emergency services as required by law.

(b) The benefit plan, if required, must be approved by the Oklahoma Insurance Department for participation in the Oklahoma market. All benefit plans must share in the cost of covered services and pharmacy products in addition to any negotiated discounts with network providers, pharmacies, or pharmaceutical manufacturers. If the benefit plan requires co-payments or deductibles, the co-payments or deductibles cannot exceed the limits described in this subsection.

- (1) An annual in-network out-of-pocket maximum cannot exceed \$3,000 per individual, excluding separate pharmacy deductibles.
- (2) Office visits cannot require a co-payment exceeding \$50 per visit.
- (3) Annual in-network pharmacy deductibles cannot exceed \$500 per individual.

(c) Qualified benefit plans will provide an EOB, an expense summary, or required documentation for paid and/or denied claims subject to member co-insurance or member deductible calculations.

The required documentation must contain, at a minimum, the:

- (1) ~~provider's~~Provider's name;
- (2) ~~patient's~~Patient's name;
- (3) ~~date(s)~~Date(s) of service;
- (4) ~~code(s)~~Code(s) and/or description(s) indicating the service(s) rendered, the amount(s) paid or the denied status of the claim(s);
- (5) ~~reason~~Reason code(s) and description(s) for any denied service(s);
- (6) ~~amount~~Amount due and/or paid from the patient or responsible party; and
- (7) ~~provider~~Provider network status (in-network or out-of-network provider).

(d) A qualified benefit plan that is participating in the Insure Oklahoma (IO) program as of November 1, 2022 may become a self-funded or self-insured benefit plan if the following conditions are met:

- (1) The qualified benefit plan has continuously participated in the premium assistance program without interruption up to the date it becomes a self-funded or self-insured health care plan;
- (2) The self-funded or self-insured benefit plan continues to be recognized as a benefit plan by the Oklahoma Insurance Department;
- (3) The self-funded or self-insured benefit plan continues to cover all essential health benefits listed in (a) of this section in addition to all other health benefits that are required under

applicable federal laws; and

4) The self-funded or self-inured benefit plan must have a monthly premium assessed and a rate schedule in order to be an approved business with the IO program.

DRAFT

**TITLE 317. OKLAHOMA HEALTH CARE AUTHORITY
CHAPTER 35. MEDICAL ASSISTANCE FOR ADULTS AND CHILDREN-
ELIGIBILITY**

**SUBCHAPTER 6. SOONERCARE FOR PREGNANT WOMEN AND FAMILIES WITH
CHILDREN**

PART 3. APPLICATION PROCEDURES

317:35-6-15. SoonerCare application for pregnant women, families with children, and expansion adults; forms

(a) **Application.** An application for pregnant women, families with children, and expansion adults consists of the SoonerCare application. The application form is signed by the individual, parent, spouse, guardian, or someone else acting on the individual's behalf. An individual does not have to have received a medical service nor expect to receive one to be certified for SoonerCare. Individuals who wish to use a paper application form to apply for coverage under a MAGI Modified Adjusted Gross Income (MAGI) eligibility group must submit the federal Single Streamlined Application to apply for SoonerCare.

(1) An application may be made in a variety of locations, for example, a physician's office, a hospital or other medical facility, Oklahoma Department of Health, in the individual's county Oklahoma Department of Human Services (OKDHS) office, or online. A face-to-face interview is not required. Applications are mailed to the ~~OHCA~~ Oklahoma Health Care Authority (OHCA) Eligibility Unit. When an individual indicates a need for SoonerCare, the physician or facility may forward an application to the OHCA Eligibility Unit for processing. If the applicant is unable to sign the application, someone acting on his/her behalf may sign the application. An application for SoonerCare may also be submitted through the Health Insurance Exchange.

(2) OKDHS form 08MA005E, Notification of Needed Medical Services, is required only for preauthorization of medical services. Although not required, the form may be submitted by the physician or facility as notification of a need for medical services. The form also may be accepted as medical verification of pregnancy.

(3) Receipt of the SoonerCare application form or OKDHS form 08MA005E constitutes an application for SoonerCare.

(4) If OKDHS form 08MA005E is received and a SoonerCare application cannot be completed, receipt of OKDHS form 08MA005E constitutes an application which must be registered and subsequently denied. The applicant and provider are notified by computer-generated notice.

(5) A hospital providing services may file an electronic Notification of Date of Service (NODOS) form with OHCA up to five (5) days from the date services are rendered. The hospital, applicant, or someone acting on the applicant's behalf has ~~fifteen (15)~~ forty (40) days from the date the NODOS form was received by OHCA to submit a completed SoonerCare application. Filing a NODOS does not guarantee coverage and if a completed application is not submitted within ~~fifteen (15)~~ forty (40) days, the NODOS is void.

(b) **Date of application.** When an application is made online, the date of application is the date the application is submitted online. The date of application for a paper application is the date a signed application is received and stamped in by contracted agency partners or OHCA. When a

request for SoonerCare is made orally, and that request is followed within twenty (20) days by a signed application, the documented date of the oral request is the date of application. When OKDHS form 08MA005E is received by OKDHS, or received by OHCA and forwarded to OKDHS, the earliest of the date stamps is considered the date of request and should be honored when followed within twenty (20) days by a signed application for SoonerCare.

(c) **Other application and signature requirements.** For additional rules regarding other application and eligibility determination procedures, see Part 7 of Subchapter 5 of this Chapter.

DRAFT

**TITLE 317. OKLAHOMA HEALTH CARE AUTHORITY
CHAPTER 30. MEDICAL PROVIDERS-FEE FOR SERVICE**

SUBCHAPTER 5. INDIVIDUAL PROVIDERS AND SPECIALTIES

PART 114. DOULA SERVICES

317:30-5-1215. General

(a) A doula or birth worker is a trained professional who provides emotional, physical, and informational support services during the prenatal, labor and delivery, and postpartum periods. Doulas are non-clinical and do not provide medical care. Services should not replace the services of other licensed and trained medical professionals including, but not limited to, physicians, physicians assistants, advanced practice registered nurses, and certified nurse midwives.

(b) All Title XIX, CHIP, expansion adult, and Soon-to-be-Sooners (STBS) members who are pregnant or within the postpartum period are eligible for doula services.

(c) Doula services are available for twelve (12) months postpartum, depending on the members continued SoonerCare eligibility.

317:30-5-1216. Eligible providers

(a) Provider requirements.

(1) Must be eighteen (18) years of age;

(2) Obtain and maintain a National Provider Identifier (NPI); and

(3) Use the taxonomy number required by the State.

(b) Certifications. Possess one of the following certifications:

(1) Birth doula;

(2) Postpartum doula;

(3) Full-spectrum doula; or

(4) Community-based doula.

(b) Certifying organization. Be certified by one of the State's recognized certifying organizations found at www.oklahoma.gov/ohca/.

317:30-5-1217. General coverage

(a) Covered benefits.

(1) Prenatal/postpartum visits. There is a total of eight (8) visits allowed for the member. The doula must work with the member to determine how best to utilize the benefit to meet the needs of the member.

(2) Labor and delivery. There is one (1) visit allowed, regardless of the duration.

(b) Visit requirements.

(1) The minimum visit length is sixty (60) minutes.

(2) Visits must be face-to-face.

(A) Prenatal and postpartum visits may be conducted via telehealth.

(B) Labor and delivery services may not be conducted via telehealth.

(c) Service locations.

(1) Prenatal and postpartum.

(A) Doulas must coordinate directly with the member and their family to determine the most appropriate service location for prenatal and postpartum visits.

(B) Service locations may include the following:

(i) Member's place of residence;

- (ii) Doula's office;
- (iii) Physician's office;
- (iv) Hospital; or
- (v) In the community.

(2) **Labor and delivery services.** There is no coverage for home birth(s).

(d) **Referral requirements.** Doula services must be recommended by a physician or other licensed practitioner of the healing arts who is operating within the scope of their practice under State law.

(1) The following providers may recommend doula services:

- (A) Obstetricians;
- (B) Certified Nurse Midwives;
- (C) Physicians;
- (D) Physician Assistants; or
- (E) Certified Nurse Practitioners.

(2) The SoonerCare Referral Form must be completed and submitted, noting the recommendation for doula services.

(e) **Prior authorization (PA) requirements.**

- (1) A PA is not required to access the standard doula benefit package.
- (2) A PA may be submitted, for members with extenuating medical circumstances, if there is need for additional visits beyond the eight (8) prenatal/postpartum visits.

(f) **Medical records requirements.** The medical record must include, but is not limited to, the following:

- (1) Date of service;
- (2) Person(s) to whom services were rendered;
- (3) Start and stop time for the service(s);
- (4) Specific services performed by the doula on behalf of the member;
- (5) Member/family response to the service;
- (6) Any new needs identified during the service; and
- (7) Original signature of the doula, including the credentials of the doula.

(g) **Auditing review.** All doula services are subject to post-payment reviews and audits by the OHCA.

(h) **Reimbursement.**

- (1) All doula services, that are outlined in Part 114 of this Chapter, are reimbursed per the methodology established in the Oklahoma Medicaid State Plan.
- (2) There are no allotted incentive payments.

**TITLE 317. OKLAHOMA HEALTH CARE AUTHORITY
CHAPTER 30. MEDICAL PROVIDERS-FEE FOR SERVICE**

SUBCHAPTER 5. INDIVIDUAL PROVIDERS AND SPECIALTIES

PART 62. PRIVATE DUTY NURSING

317:30-5-561. Private duty nursing (PDN) payment rates

(a) All PDN services, including overtime, are reimbursed per the methodology described in the Oklahoma Medicaid State Plan.

(b) Overtime payment for PDN services is only available for nursing staff who are providing services to members with tracheostomies or who are medically dependent on a ventilator for life support at least six (6) hours per day. This excludes members who are on non-invasive C-PAP or Bi-PAP devices only.

(c) In accordance with the Department of Fair Labor Standards Act, a worker must receive overtime pay for every hour that is worked over forty (40) hours in a workweek. A workweek is defined as any set seven (7) day period.

This page intentionally left blank

TITLE 317. OKLAHOMA HEALTH CARE AUTHORITY
CHAPTER 30. MEDICAL PROVIDERS-FEE FOR SERVICE
SUBCHAPTER 5. INDIVIDUAL PROVIDERS AND SPECIALTIES
PART 9. LONG-TERM CARE FACILITIES

317:30-5-136.2 Intermediate Care Facilities for Individuals with Intellectual Disabilities (ICFs/IID) Enhanced Payment Program

(a) Overview. This program provides enhanced payment for private ICFs/IID that provide vocational services or day program services or both. The purpose of the enhanced payment is to offset the costs incurred by ICFs/IID in the provision of vocational services or day program services or both. Residents who qualify for the enhanced program cannot receive the same services or reimbursement under another program.

(b) Definitions. The following words and terms, when used in this Section, will have the following meaning, unless the context clearly indicates otherwise:

"Day program services" means a life enrichment program that is conducted in a dedicated service location. The organized scheduled programming will vary but must meet the specific program qualifications for participation. Day services programs provide diverse opportunities for residents to participate in the broader community based on the resident's specific care plan.

"Direct costs" means the costs for activities or items associated with day services and/or vocational services programs. These items include salaries and wages of activities staff, day services and vocational staff, and job coaches.

"Other costs" means overhead costs attributable to the provision of day and vocational services. For example, rent, utilities, etc., not already paid for by Medicaid.

"Quality Review Committee" means a committee responsible for the oversight of monitoring and analyzing the accessibility and appropriateness of services being delivered.

"Vocational services" means the provision of paid employment in a structured vocational training program for residents outside of the resident's home. The type of work will vary but each provider must meet the specific program qualifications for participation. Vocational service programs provide pre-vocational services training, that prepare the residents for employment in a structured educational program. These programs will utilize either a certified job coach or a designated staff, to assist a resident eighteen (18) years and older, in achieving gainful employment. Other achievements may include, sheltered employment, ongoing employment support, job skills training and/or workshop experience in the community.

(c) Care criteria. Facilities will comply with the following care criteria to receive the enhanced payment:

(1) Vocational services. Facilities will provide twenty (20) hours of vocational services to at least forty percent (40%) of their residents each week. Residents must participate at least nine (9) out of twelve (12) weeks.

(2) Day services. Facilities will provide twenty (20) hours of day services to at least sixty percent (60%) of the facility's residents who do not participate in the facility's vocational program. Residents must participate at least nine (9) out of twelve (12) weeks.

(d) Performance Review. Performance reviews will be completed quarterly to ensure the integrity and accountability of the vocational and/or day treatment services provided. Facilities shall provide documentation as requested and directed by the Oklahoma Health Care Authority (OHCA)

within fifteen (15) business days of request. Program payments will be withheld from facilities that fail to meet performance review standards.

(e) **Appeals.** Facilities can file an appeal related to their performance review with the Quality Review Committee and in accordance with the grievance procedures found at Oklahoma Administrative Code (OAC) 317:2-1-2 and 317:2-1-17.

(f) **Reimbursement methodology and payment.** Reimbursement and payment for the ICF/IID Enhanced Payment Program are provided in accordance with the Oklahoma Medicaid State Plan.

(g) **Cost audit.** Each facility will be audited annually as part of the annual cost report reviews to ensure only allowable costs prescribed by Medicare/Medicaid cost reporting principles are reported. As part of the annual audit, OHCA will ensure that there are no duplicative costs attributable to base rate and the enhanced payments. Payments will be recouped from facilities that report unallowable costs. Additional audits can be conducted anytime at the discretion of the OHCA.

DRAFT

**TITLE 317. OKLAHOMA HEALTH CARE AUTHORITY
CHAPTER 30. MEDICAL PROVIDERS-FEE FOR SERVICE**

SUBCHAPTER 3. GENERAL PROVIDER POLICIES

PART 1. GENERAL SCOPE AND ADMINISTRATION

317:30-3-27. Telehealth

(a) **Definitions.** The following words and terms, when used in this Section, shall have the following meaning, unless the context clearly indicates otherwise.

(1) **"Remote patient monitoring"** means the use of digital technologies to collect medical and other forms of health data (e.g., vital signs, weight, blood pressure, blood sugar) from individuals in one (1) location and electronically transmit that information securely to health care providers in a different location for assessment and recommendations.

(2) **"School-based services"** means medically necessary health-related and rehabilitative services that are provided by a qualified school provider to a student under the age of twenty-one (21), pursuant to an Individualized Education Program (IEP), in accordance with the Individuals with Disabilities Education Act. See Oklahoma Administrative Code (OAC) 317:30-5-1020.

(3) **"Store and forward technologies"** means the transmission of a patient's medical information from an originating site to the health care provider at the distant site; provided, photographs visualized by a telecommunications system shall be specific to the patient's medical condition and adequate for furnishing or confirming a diagnosis or treatment plan. Store and forward technologies shall not include consultations provided by telephone audio-only communication, electronic mail, text message, instant messaging conversation, website questionnaire, nonsecure video conference, or facsimile transmission.

(4) **"Telehealth"** means the practice of health care delivery, diagnosis, consultation, evaluation and treatment, transfer of medical data or exchange of medical education information by means of a two-way, real-time interactive communication, not to exclude store and forward technologies, between a patient and a ~~health care~~ healthcare provider with access to and reviewing the patient's relevant clinical information prior to the telemedicine visit. Telehealth shall not include consultations provided by telephone audio-only communication, electronic mail, text message, instant messaging conversation, website questionnaire, nonsecure video conference, or facsimile transmission. For audio-only health service delivery, see OAC 317:30-3-27.1.

(5) **"Telehealth medical service"** means, for the purpose of the notification requirements of OAC 317:30-3-27(d)(2), telehealth services that expressly do not include physical therapy, occupational therapy, and/or speech and hearing services.

(b) **Applicability and scope.** The purpose of this Section is to implement telehealth policy that improves access to ~~health care~~ healthcare services, while complying with all applicable state and federal laws and regulations. Telehealth services are not an expansion of SoonerCare-covered services, but an option for the delivery of certain covered services. However, if there are technological difficulties in performing an objective, thorough medical assessment, or problems in the member's understanding of telehealth, hands-on-assessment and/or in-person care must be provided for the member. Any service delivered using telehealth technology must be appropriate for telehealth delivery and be of the same quality and otherwise on par with the same service delivered in person. A telehealth encounter must maintain the confidentiality and security of

protected health information in accordance with applicable state and federal law, including, but not limited to, 42 Code of Federal Regulations (CFR) Part 2, 45 CFR Parts 160 and 164, and 43A Oklahoma Statutes (O.S.) § 1-109. For purposes of SoonerCare reimbursement, telehealth is the use of interactive audio, video, or other electronic media for the purpose of diagnosis, consultation, or treatment that occurs in real-time and when the member is actively participating during the transmission.

(c) **Requirements.** The following requirements apply to all services rendered via telehealth.

(1) Interactive audio and video telecommunications must be used, permitting encrypted, real-time communication between the physician or practitioner and the SoonerCare member. The telecommunication service must be secure and adequate to protect the confidentiality and integrity of the telehealth information transmitted. As a condition of payment the member must actively participate in the telehealth visit.

(2) The telehealth equipment and transmission speed and image must be technically sufficient to support the service billed. If a peripheral diagnostic scope is required to assess the member, it must provide adequate resolution or audio quality for decision making. Staff involved in the telehealth visit need to be trained in the use of the telehealth equipment and competent in its operation.

(3) The medical or behavioral health related service must be provided at an appropriate site for the delivery of telehealth services. An appropriate telehealth site is one that has the proper security measures in place; the appropriate administrative, physical, and technical safeguards should be in place that ensures the confidentiality, integrity, and security of electronic protected health information. The location of the room for the encounter at both ends should ensure comfort, privacy, and confidentiality. Both visual and audio privacy are important, and the placement and selection of the rooms should consider this. Appropriate telehealth equipment and networks must be used considering factors such as appropriate screen size, resolution, and security. Providers and/or members may provide or receive telehealth services outside of Oklahoma when medically necessary; however, prior authorization may be required, per OAC 317:30-3-89 through 317:30-3-91.

(4) The provider must be contracted with SoonerCare and appropriately licensed or certified, in good standing. Services that are provided must be within the scope of the practitioner's license or certification. If the provider is outside of Oklahoma, the provider must comply with all laws and regulations of the provider's location, including health care and telehealth requirements.

(5) If the member is a minor, the provider must obtain the prior written consent of the member's parent or legal guardian to provide services via telehealth, that includes, at a minimum, the name of the provider; the provider's permanent business office address and telephone number; an explanation of the services to be provided, including the type, frequency, and duration of services. Written consent must be obtained annually, or whenever there is a change in the information in the written consent form, as set forth above. The parent or legal guardian need not attend the telehealth session unless attendance is therapeutically appropriate. The requirements of subsection OAC 317:30-3-27(c)(5), however, do not apply to telehealth services provided in a primary or secondary school setting.

(6) If the member is a minor, the telehealth provider shall notify the parent or legal guardian that a telehealth service was performed on the minor through electronic communication whether a text message or email.

(7) The member retains the right to withdraw at any time.

(8) All telehealth activities must comply with Oklahoma Health Care Authority (OHCA)

policy, and all other applicable State and Federal laws and regulations, including, but not limited to, 59 O.S. § 478.1.

(9) The member has access to all transmitted medical information, with the exception of live interactive video as there is often no stored data in such encounters.

(10) There will be no dissemination of any member images or information to other entities without written consent from the member or member's parent or legal guardian, if the member is a minor.

(11) A telehealth service is subject to the same SoonerCare program restrictions, limitations, and coverage which exist for the service when not provided through telehealth; provided, however, that only certain telehealth codes are reimbursable by SoonerCare. For a list of the SoonerCare-reimbursable telehealth codes, refer to the OHCA's Behavioral Health Telehealth Services and Medical Telehealth Services, available on OHCA's website, www.okhca.org.

(12) Where there are established service limitations, the use of telehealth to deliver those services will count towards meeting those noted limitations. Service limitations may be set forth by Medicaid and/or other ~~third party~~third-party payers.

(d) Additional requirements specific to telehealth services in a school setting. In order for OHCA to reimburse medically necessary telehealth services provided to SoonerCare members in a primary or secondary school setting, all of the requirements in (c) above must be met, with the exception of (c)(5), as well as all of the requirements shown below, as applicable.

(1) **Consent requirements.** Advance parent or legal guardian consent for telehealth services must be obtained for minors, in accordance with 25 O.S. §§ 2004 through 2005. Additional consent requirements shall apply to school-based services provided pursuant to an IEP, per OAC 317:30-5-1020.

(2) **Notification requirements.** For telehealth medical services provided in a primary or secondary school setting, the telehealth practitioner must provide a summary of the service, including, but not limited to, information regarding the exam findings, prescribed or administered medications, and patient instructions, to:

(A) The SoonerCare member, if he or she is an adult, or the member's parent or legal guardian, if the member is a minor; or

(B) The SoonerCare member's primary care provider, if requested by the member or the member's parent or legal guardian.

(3) **Requirements specific to physical therapy, occupational therapy, and/or speech and hearing services.** Even though physical therapy, occupational therapy, and/or speech and hearing services are not subject to the notification requirements of OAC 317:30-3-27(d)(2), said services must still comply with all other State and Federal Medicaid requirements, in order to be reimbursable by Medicaid. Accordingly, for those physical therapy, occupational therapy, and/or speech and hearing services that are provided in a primary or secondary school setting, but that are not school-based services (i.e., not provided pursuant to an IEP), providers must adhere to all state and federal requirements relating to prior authorization and prescription or referral, including, but not limited to, 42 C.F.R. § 440.110, OAC 317:30-5-291, 317:30-5-296, and 317:30-5-676.

(e) Reimbursement.

(1) Health care services delivered by telehealth such as Remote Patient Monitoring, Store and Forward, or any other telehealth technology, must be compensable by OHCA in order to be reimbursed.

(2) Services provided by telehealth must be billed with the appropriate modifier.

(3) If the technical component of an X-ray, ultrasound or electrocardiogram is performed

during a telehealth transmission, the technical component can be billed by the provider that provided that service. The professional component of the procedure and the appropriate visit code should be billed by the provider that rendered that service.

(4) The cost of telehealth equipment and transmission is not reimbursable by SoonerCare.

(5) For reimbursement of audio-only health service delivery, see OAC 317:30-3-27.1.

(f) Documentation.

(1) Documentation must be maintained by the rendering provider to substantiate the services rendered.

(2) Documentation must indicate the services were rendered via telehealth, and the location of the services.

(3) All other SoonerCare documentation guidelines apply to the services rendered via telehealth. Examples include but are not limited to:

(A) Chart notes;

(B) Start and stop times;

(C) Service provider's credentials; and

(D) Provider's signature.

(g) Final authority. The OHCA has discretion and the final authority to approve or deny any telehealth services based on agency and/or SoonerCare members' needs.

317:30-3-27.1 Audio-only health service delivery

(a) Definition. "Audio-only health service delivery" means the delivery of healthcare services through the use of audio-only telecommunications, permitting real-time communication between a patient and the provider, for the purpose of diagnosis, consultation, and/or treatment. Audio-only health service delivery does not include the use of facsimile, email, or health care services that are customarily delivered by audio-only telecommunications and not billed as separate services by the provider, such as the sharing of laboratory results. This definition includes health services delivered via audio-only when audio-visual is unavailable or when a member chooses audio-only.

(b) Purpose. Health services delivered via audio-only telecommunications are intended to improve access to healthcare services, while complying with all applicable state and federal laws and regulations. Audio-only telecommunications is an option for the delivery of certain covered services and is not an expansion of SoonerCare-covered services.

(c) Applicability and scope.

(1) Health service delivery via audio-only telecommunications is applicable to medically necessary covered primary care and other approved health services. Refer to the Oklahoma Health Care Authority (OHCA) website, www.okhca.org, for a complete list of the SoonerCare-reimbursable audio-only health services codes.

(2) If there are technological difficulties in performing medical assessment through audio-only telecommunications, then hands-on-assessment and/or in-person care must be provided for the member. Any service delivered using audio-only telecommunications must be appropriate for audio-only delivery and be of the same quality and otherwise on par with the same service delivered in person.

(3) Confidentiality and security of protected health information in accordance with applicable state and federal law, including, but not limited to, 42 Code of Federal Regulations (CFR) Part 2, 45 CFR Parts 160 and 164, and 43A Oklahoma Statutes (O.S.) § 1-109, must be maintained in the delivery of health services by audio-only telecommunications.

(4) For purposes of SoonerCare reimbursement, audio-only health service delivery is the use

of interactive audio technology for the purpose of diagnosis, consultation, and/or treatment that occurs in real-time and when the member is actively participating during the transmission.

(d) Requirements. The following requirements apply to all services rendered via audio-only health service delivery:

(1) Interactive audio telecommunications must be used, permitting real-time communication between the physician or practitioner and the SoonerCare member. As a condition of payment, the member must actively participate in the audio-only telecommunications health service visit.

(2) The audio telecommunications technology used to deliver the services must meet the standards required by state and federal laws governing the privacy and security of protected health information (PHI).

(3) The provider must be contracted with SoonerCare and appropriately licensed and/or certified, and in good standing. Services that are provided must be within the scope of the practitioner's license and/or certification.

(4) Either the provider or the member must be located at the freestanding clinic that is providing services pursuant to 42 CFR § 440.90 and Oklahoma Administrative Code (OAC) 317:30-5-575.

(5) If the member is a minor, the provider must obtain the prior written consent of the member's parent or legal guardian to provide services via audio-only telecommunications, that includes, at a minimum, the name of the provider; the provider's permanent business office address and telephone number; and an explanation of the services to be provided, including the type, frequency, and duration of services. Written consent must be obtained annually, or whenever there is a change in the information in the written consent form, as set forth above. The parent or legal guardian need not attend the audio-only telecommunications session unless attendance is therapeutically appropriate.

(6) The member retains the right to withdraw at any time.

(7) All audio-only health service delivery activities must comply with Oklahoma Health Care Authority (OHCA) policy, and all other applicable State and Federal laws and regulations.

(8) A health service delivered via audio-only telecommunications is subject to the same SoonerCare program restrictions, limitations, and coverage which exist for the service when not delivered via audio-only telecommunications.

(9) A health service delivered by audio-only telecommunications must be designated for reimbursement by SoonerCare.

(10) Where there are established service limitations, the use of audio-only telecommunications to deliver those services will count towards meeting those noted limitations. Service limitations may be set forth by Medicaid and/or other third-party payers.

(d) Reimbursement.

(1) Health care services delivered via audio-only telecommunications must be compensable by OHCA in order to be reimbursed.

(2) Services delivered via audio-only telecommunications must be billed with the appropriate modifier.

(3) Health care services delivered via audio-only telecommunications are reimbursed pursuant to the fee-for-service fee schedule approved under the Oklahoma Medicaid State Plan.

(4) An RHC and an FQHC shall be reimbursed for services delivered via audio-only telecommunications at the fee-for-service rate per the fee-for-service fee schedule.

(5) An I/T/U shall be reimbursed for services delivered via audio-only telecommunications at the Office of Management and Budget (OMB) all-inclusive rate.

(6) The cost of audio-only telecommunication equipment and other service related costs are not reimbursable by SoonerCare.

(e) Documentation.

(1) Documentation must be maintained by the rendering provider to substantiate the services rendered.

(2) Documentation must indicate the services were rendered via audio-only telecommunications, and the location of the services.

(3) All other SoonerCare documentation guidelines apply to the services rendered via audio-only telecommunications. Examples include but are not limited to:

(A) Chart notes;

(B) Start and stop times;

(C) Service provider's credentials; and

(D) Provider's signature.

(f) Final authority. The OHCA has discretion and final authority to approve or deny any services delivered via audio-only telecommunications based on agency and/or SoonerCare members' needs.

SUBCHAPTER 5. INDIVIDUAL PROVIDERS AND SPECIALTIES

PART 21. OUTPATIENT BEHAVIORAL HEALTH AGENCY SERVICES

317:30-5-241.2. Psychotherapy

(a) Individual psychotherapy.

(1) **Definition.** Psychotherapy is a ~~face-to-face~~ treatment for mental illnesses and behavioral disturbances, in which the clinician, through definitive therapeutic communication, attempts to alleviate the emotional disturbances, reverse, or change maladaptive patterns of behavior, and encourage growth and development. Insight oriented, behavior modifying and/or supportive psychotherapy refers to the development of insight of affective understanding, the use of behavior modification techniques, the use of supportive interactions, the use of cognitive discussion of reality, or any combination of these items to provide therapeutic change. Ongoing assessment of the member's status and response to treatment as well as psycho-educational intervention are appropriate components of individual therapy. The therapy must be goal directed, utilizing techniques appropriate to the service plan and the member's developmental and cognitive abilities.

(2) **Interactive complexity.** Psychotherapy is considered to involve "interactive complexity" when there are communication factors during a visit that complicate delivery of the psychotherapy by the qualified practitioner. Sessions typically involve members who have other individuals legally responsible for their care (i.e., minors or adults with guardians); members who request others to be involved in their care during the session (i.e., adults accompanied by one or more participating family members or interpreter or language translator); or members that require involvement of other third parties (i.e., child welfare, juvenile justice, parole/probation officers, schools, etc.). Psychotherapy should only be reported as involving interactive complexity when at least one (1) of the following communication factors is present:

(A) The need to manage maladaptive communication (i.e., related to high anxiety, high reactivity, repeated questions, or disagreement) among participants that complicate delivery of care.

(B) Caregiver emotions/behavior that interfere with implementation of the service plan.

(C) Evidence/disclosure of a sentinel event and mandated report to a third party (i.e., abuse or neglect with report to state agency) with initiation of discussion of the sentinel event and/or report with patient and other visit participants.

(D) Use of play equipment, physical devices, interpreter, or translator to overcome barriers to therapeutic interaction with a patient who is not fluent in the same language or who has not developed or lost expressive or receptive language skills to use or understand typical language.

(3) **Qualified practitioners.** Psychotherapy must be provided by an ~~LBHP~~Licensed Behavioral Health Practitioner (LBHP) or licensure candidate in a setting that protects and assures confidentiality.

(4) **Documentation requirements.** Providers must comply with documentation requirements in ~~OAC~~Oklahoma Administrative Code (OAC) 317:30-5-248.

(5) **Limitations.** A maximum of four (4) units per day per member is compensable. A cumulative maximum of eight (8) units of individual psychotherapy and family psychotherapy per week per member is compensable. Except for psychotherapy involving interactive complexity as described in this Section, only the member and the qualified practitioner should be present during the session. Individual psychotherapy is not reimbursable for a child younger than the age of thirty-six (36) months. Limitations exclude outpatient behavioral health services provided in a foster care setting.

(b) **Group psychotherapy.**

(1) **Definition.** Group psychotherapy is a method of treating behavioral disorders using the face-to-face psychotherapeutic interaction between the qualified practitioner and two (2) or more individuals to promote positive emotional or behavioral change. The focus of the group must be directly related to the goals and objectives in the individual member's current service plan. This service does not include social or daily living skills development as described under behavioral health rehabilitation services.

(2) **Group sizes.** Group psychotherapy is limited to a total of eight (8) adult [eighteen (18) and over] individuals except when the individuals are residents of an ICF/IIDIntermediate Care Facility for Individuals with Intellectual Disabilities (ICF/IID) where the maximum group size is six (6). For all children under the age of eighteen (18), the total group size is limited to six (6).

(3) **Multi-family and conjoint family therapy.** Sessions are limited to a maximum of eight (8) families/units. Billing is allowed once per family unit, though units may be divided amongst family members.

(4) **Qualified practitioners.** Group psychotherapy must be provided by an LBHP or licensure candidate. Group psychotherapy must take place in a confidential setting limited to the qualified practitioner, an assistant or co-therapist, if desired, and the group psychotherapy participants.

(5) **Documentation requirements.** Providers must comply with documentation requirements in OAC 317:30-5-248.

(6) **Limitations.** A maximum of six (6) units per day per member is compensable, not to exceed twelve (12) units per week. Group psychotherapy is not reimbursable for a child younger than the age of thirty-six (36) months. Limitations exclude outpatient behavioral health services provided in a foster care setting.

(c) **Family psychotherapy.**

(1) **Definition.** Family psychotherapy is a face-to-face psychotherapeutic interaction between a qualified practitioner and the member's family, guardian, and/or support system. It is

typically inclusive of the identified member but may be performed if indicated without the member's presence. When the member is an adult, his/her permission must be obtained in writing. Family psychotherapy must be provided for the direct benefit of the SoonerCare member to assist him/her in achieving his/her established treatment goals and objectives and it must take place in a confidential setting. This service may include the evidence-based practice "Family Psychoeducation". For children under the age of thirty-six (36) months, family psychotherapy is focused on the infant/young child and parent (or primary caregiver) interactions and the relationship needs of the infant/young child.

(2) **Qualified practitioners.** Family psychotherapy must be provided by an LBHP or licensure candidate.

(3) **Documentation requirements.** Providers must comply with documentation requirements in OAC 317:30-5-248.

(4) **Limitations.** A maximum of four (4) units per day per member/family unit is compensable. A cumulative maximum of eight (8) units of individual psychotherapy and family psychotherapy per week per member is compensable. Family psychotherapy for a child younger than thirty-six (36) months must be medically necessary and meet established child [zero (0) through thirty-six (36) months of age] criteria as set forth in the Prior Authorization Manual. Limitations exclude outpatient behavioral health services provided in a foster care setting.

PART 35. RURAL HEALTH CLINICS

317:30-5-354. Definitions

The following words and terms, when used in this Chapter, shall have the following meaning, unless the context clearly indicates otherwise:

"**APRN**" means advanced practice registered nurse.

"**C.F.R.**" means the U.S. Code of Federal Regulations.

"**CLIA**" means the Clinical Laboratory Improvement Amendments.

"**CMS**" means the Centers for Medicare and Medicaid Services.

"**CNM**" means certified nurse midwife.

"**Core services**" means outpatient services that may be covered when furnished to a patient at the rural health clinic (RHC) or other location, including the patient's place of residence.

"**CP**" means clinical psychologist.

"**CPT**" means current procedural terminology.

"**CSW**" means clinical social worker.

"**EPSDT**" means the Early and Periodic Screening, Diagnostic and Treatment program for members under twenty-one (21).

"**FFS**" means the current OHCA's fee-for-service reimbursement rate.

"**HCPCS**" means Healthcare Common Procedure Coding System.

"**OAC**" means the Oklahoma Administrative Code.

"**OHCA**" means the Oklahoma Health Care Authority.

"**Other ambulatory services**" means other outpatient health services covered under the Oklahoma Medicaid State Plan other than core services.

"**PA**" means physician assistant.

"**Physician**" means:

(A) A doctor of medicine or osteopathy legally authorized to practice medicine and surgery by the State in which the function is performed or who is a licensed physician employed by the Public Health Service;

(B) Within limitations as to the specific services furnished, a doctor of dentistry or dental, a doctor of optometry, or a doctor of podiatry.

"Physicians' services" means professional services that are performed by a physician at the RHC (or are performed away from the Center, excluding inpatient hospital services) whose agreement with the RHC provides that he or she will be paid by the RHC for such services.

"PPS" means prospective payment system all-inclusive per visit rate method specified in the Oklahoma Medicaid State Plan.

"RHC" means rural health clinic.

"Visit" means a face-to-face encounter between a clinic patient and a physician, ~~PA, APRN, CNM, CP or CSW~~ Physician Assistant (PA), APRN Advanced Practice Registered Nurse (APRN), CNM Certified Nurse Midwife (CMN), CP Clinical Psychologist (CP), or CSW Clinical Social Worker whose services are reimbursed under the RHC PPS payment method. Encounters with more than one (1) health care professional and multiple encounters with the same health care professional that take place on the same day and at a single location constitute a single visit, except when the patient, after the first encounter, suffers illness or injury requiring additional diagnosis or treatment. Services delivered via audio-only telecommunications and reimbursed pursuant to the fee-for-service (FFS) fee schedule do not constitute a visit and/or an encounter.

317:30-5-355.2. Covered services

The ~~RHC~~ Rural Health Center benefit package, as described in 42 C.F.R. § 440.20, consists of RHC services and other ambulatory services.

(1) **RHC services.** RHC services are covered when medically necessary and furnished at the clinic or other outpatient setting, including the member's place of residence, delivered via telehealth, or via audio-only telecommunications pursuant to Oklahoma Administrative Code (OAC) 317:30-3-27 and OAC 317:30-3-27.1.

(A) **Core services.** RHC "core" services include, but are not limited to:

(i) Services furnished by a physician, ~~PA~~ Physician Assistant (PA), APRN Advanced Practice Registered Nurse (APRN), CNM Certified Nurse Midwife (CMN), CP Clinical Psychologist (CP), or CSW Clinical Social Worker.

(ii) Services and supplies incident to services provided by a physician, PA, APRN, CNM, CP, or CSW are covered in accordance with 42 C.F.R §§ 405.2413 and 405.2415, if the service or supply is:

(I) Furnished in accordance with State law;

(II) A type commonly furnished in physicians' offices;

(III) A type commonly rendered either without charge or included in the RHC's bill;

(IV) Furnished as an incidental, although integral, part of a physician's professional services, PA, APRN, CNM, CP or CSW; or

(V) Furnished under the direct supervision of a contracted physician PA, APRN, or CNM; and

(VI) Drugs and biologicals which cannot be self-administered or are specifically covered by Medicare law, are included within the scope of RHC services. Drugs and biologicals commonly used in life saving procedures, such as analgesics, anesthetics (local), antibiotics, anticonvulsants, antidotes and emetics, serums and toxoids are not billed separately.

(iii) Visiting nurse services to the homebound are covered if:

(I) The RHC is located in an area in which the Secretary of Health and Human

Services has determined there is a shortage of home health agencies;
(II) The services are rendered to members who are homebound;
(III) The member is furnished nursing care on a part-time or intermittent basis by a registered nurse, licensed practical nurse, or licensed vocational nurse who is employed by or receives compensation for the services from the RHC; and
(IV) The services are furnished under a written plan of treatment as required by 42 C.F.R § 405.2416.

(iv) Certain virtual communication services.

(B) **Preventive services.** In addition to the professional services of a physician, and services provided by an APRN, PA, and CNM which would be covered as RHC services under Medicare, certain primary preventive services are covered under the SoonerCare RHC benefit. The services must be furnished by or under the direct supervision of an RHC practitioner who is a clinic employee:

(i) Prenatal and postpartum care;

(ii) Screening examination under the EPSDT program for members under twenty-one (21);

(iii) Family planning services; and

(iv) Medically necessary screening mammography and follow-up mammograms.

(C) **Off-site services.** RHC services provided off-site of the clinic are covered if the RHC has a compensation arrangement with the RHC practitioner. SoonerCare reimbursement is made to the RHC and the RHC practitioner receives his or her compensation from the RHC. The RHC must have a written contract with the physician and other RHC "core" practitioners that specifically identify how the RHC services provided off-site are to be billed to SoonerCare. It is expected that services provided in off-site settings are, in most cases, temporary and intermittent, i.e., when the member cannot come to the clinic due to health reasons.

(2) **Other ambulatory services.** Other ambulatory services that may be provided by an RHC include non-primary care services covered by the Oklahoma Medicaid State Plan but are not included in the RHC's core services. These services are separately billable and may be provided by the RHC if the RHC meets the same standards as other contracted providers of those services.

(A) Other ambulatory services include, but are not limited to:

(i) Dental services for members under the age of twenty-one (21) provided by other than a licensed dentist;

(ii) Optometric services provided by other than a licensed optometrist;

(iii) Laboratory tests performed in the RHC lab, including the lab tests required for RHC certification;

(I) Chemical examinations of urine by stick or tablet method or both (including urine ketones);

(II) Hemoglobin or hematocrit;

(III) Blood glucose;

(IV) Examination of stool specimens for occult blood;

(V) Pregnancy tests; and

(VI) Primary culturing for transmittal to a certified laboratory.

(iv) Technical component of diagnostic tests such as x-rays and EKGs (interpretation of the test provided by the RHC physician is included in the encounter rate);

(v) Durable medical equipment;

- (vi) Transportation by ambulance;
 - (vii) Prescribed drugs;
 - (viii) Prosthetic devices (other than dental) which replace all or part of an internal body organ (including colostomy bags) and supplies directly related to colostomy care and the replacement of such devices;
 - (ix) Specialized laboratory services furnished away from the clinic;
 - (x) Inpatient services;
 - (xi) Outpatient hospital services; and
 - (xii) Applied behavior analysis (ABA); and
 - (xiii) Diabetes self-management education and support (DSMES) services.
- (B) Services listed in (2)(A) of this Section, furnished on-site, require a separate provider agreement(s) with the OHCA. Service item (2)(A)(iii) does not require a separate contract when furnished on-site, however, certain conditions of participation apply. (Refer to OAC 317:30-5-361 for conditions.)

PART 64. CLINIC SERVICES

317:30-5-575. General information

(a) **Clinic services.** Clinic services means preventive, diagnostic, therapeutic, rehabilitative, or palliative services that are furnished by a facility that is not part of a hospital but is organized and operated to provide medical care to outpatients. The term includes the following services furnished to outpatients:

- (1) Services furnished at the clinic by or under the direction of a physician or a dentist.
- (2) Services furnished outside the clinic, by clinic personnel under the direction of a physician, to an eligible individual who does not reside in a permanent dwelling or does not have a fixed home or mailing address.
- (3) Telehealth and audio-only health service delivery requires either the provider or the member to be located at the freestanding clinic that is providing services pursuant to 42 Code of Federal Regulations (CFR) § 440.90. Refer to section Oklahoma Administrative Code (OAC) 317:30-3-27 for telehealth policy and OAC 317:30-3-27.1 for audio-only telecommunication policy.

(b) **Prior authorization.** OHCA requires prior authorization for certain procedures to validate the medical need for the service.

(c) **Medical necessity.** Medical necessity requirements are listed at OAC 317:30-3-1(f).

PART 75. FEDERALLY QUALIFIED HEALTH CENTERS

317:30-5-664.3. ~~FQHC~~ Federally Qualified Health Center (FQHC) encounters

(a) FQHC encounters that are billed to the ~~OHCA~~ Oklahoma Health Care Authority (OHCA) must meet the definition in this Section and are limited to services covered by OHCA. Only encounters provided by an authorized health care professional listed in the approved FQHC State Plan pages within the scope of their licensure trigger a ~~PPS~~ Prospective Payment System (PPS) encounter rate.

(b) An encounter is defined as a face-to-face contact between a health care professional and a member for the provision of defined services through a FQHC within a twenty-four (24) hour period ending at midnight, as documented in the member's medical record. Services delivered via audio-only telecommunications do not constitute an encounter.

(c) An FQHC may bill for one (1) medically necessary encounter per twenty-four (24) hour period

when the appropriate modifier is applied. Medical review will be required for additional visits for children. For information about multiple encounters, refer to 2020 Oklahoma Administrative Code (OAC) 317:30-5-664.4. Payment is limited to four (4) visits per member per month for adults. This limit may be exceeded if the SoonerCare Choice member has elected the FQHC as his/her/their Patient Centered Medical Home/Primary Care Provider.

(d) Services considered reimbursable encounters (including any related medical supplies provided during the course of the encounter) include:

- (1) Medical;
- (2) Diagnostic;
- (3) Dental, medical and behavioral health screenings;
- (4) Vision;
- (5) Physical therapy;
- (6) Occupational therapy;
- (7) Podiatry;
- (8) Behavioral health;
- (9) Speech;
- (10) Hearing;
- (11) Medically necessary FQHC encounters with a registered nurse or licensed practical nurse and related medical supplies (other than drugs and biologicals) furnished on a part-time or intermittent basis to home-bound members (refer to OAC 317:30-5-661.3); and
- (12) Any other medically necessary health services (i.e. optometry and podiatry) are also reimbursable as permitted within the FQHCs scope of services when medically reasonable and necessary for the diagnosis or treatment of illness or injury, and must meet all applicable coverage requirements.

(e) Services and supplies incident to the services of a physician, PA, APRN, CNM, CP and CSW are reimbursable within the encounter, as described in 42 C.F.R § 405.2413 and OAC 317:30-5-661.1.

(f) Only drugs and biologicals which cannot be self-administered are included within the scope of this benefit.

317:30-5-664.10. Health Center reimbursement

(a) In accordance with Section 702 of the Medicare, Medicaid and SCHIP Benefits Improvement and Protection Act (BIPA) of 2000, reimbursement is provided for core services and other health services at a Health Center facility-specific Prospective Payment System (PPS) rate per visit (encounter) determined according to the methodology described in 2020 Oklahoma Administrative Code (OAC) 317:30-5-664.12.

(b) As claims/encounters are filed, reimbursement for SoonerCare Choice members is made for all medically necessary covered primary care and other approved health services at the PPS rate, except for services delivered via audio-only telecommunications which are reimbursed at the fee-for-service (FFS) rate pursuant to the FFS fee schedule.

(c) Primary and preventive behavioral health services rendered by health care professionals authorized in the FQHC Federally Qualified Health Center (FQHC) approved state plan pages will be reimbursed at the PPS encounter rate, except for services delivered via audio-only telecommunications which are reimbursed at the FFS rate pursuant to the FFS fee schedule.

(d) Vision services provided by Optometrists within the scope of their licensure for non-dual eligible members and allowed under the Medicaid State Plan are reimbursed pursuant to the SoonerCare ~~fee-for-service~~ FFS fee schedule.

**PART 110. INDIAN HEALTH SERVICES, TRIBAL PROGRAMS, AND URBAN
INDIAN CLINICS (I/T/Us)**

317:30-5-1087. Terms and definitions

The following words and terms, when used in this Part, have the following meaning, unless the context clearly indicates otherwise:

(1) **"American Indian/Alaska Native (AI/AN)"** means an individual of Native American descent who has or is eligible for a Certificate of Degree of Indian Blood (CDIB) card.

(2) **"Audio-only health service delivery"** means the delivery of healthcare services through the use of audio-only telecommunications, permitting real-time communication between a patient and the provider, for the purpose of diagnosis, consultation, or treatment, and does not include the use of facsimile or email nor the delivery of health care services that are customarily delivered by audio-only telecommunications and customarily not billed as separate services by the provider, such as the sharing of laboratory results. This definition includes health services delivered via audio-only when audio-visual is unavailable or when a member chooses audio-only.

~~(2)~~(3) **"Behavioral Health services"** means professional medical services for the treatment of a mental health and/or substance use disorder.

~~(3)~~(4) **"CFR"** means the Code of Federal Regulations.

~~(4)~~(5) **"CMS"** means the Centers for Medicare and Medicaid Services.

~~(5)~~(6) **"Encounter"** means a face-to-face contact between a health care professional and an IHS eligible SoonerCare member for the provision of medically necessary Title XIX or Title XXI covered services through an IHS or Tribal 638 facility or an urban Indian clinic within a ~~24-hour~~twenty-four (24) hour period ending at midnight, as documented in the patient's record.

~~(6)~~(7) **"Licensed Behavioral Health Professional (LBHP)"** means a licensed psychologist, licensed clinical social worker (LCSW), licensed marital and family therapist (LMFT), licensed professional counselor (LPC), licensed behavioral practitioner (LBP) or licensed alcohol and drug counselor (LADC).

~~(7)~~(8) **"OHCA"** means the Oklahoma Health Care Authority.

~~(8)~~(9) **"OMB rate"** means the Medicaid reimbursement rate negotiated between CMS and IHS. Inpatient and outpatient Medicaid reimbursement rates for I/T/Us are published annually in the Federal Register or Federal Register Notices. The outpatient rate is also known as the I/T/U encounter rate. The encounter rate is available only to I/T/U facilities that appear on the IHS maintained listing of IHS-operated and Indian health care facilities operating under a 638 agreement. It is the sole responsibility of the facility to petition IHS for placement on this list.

~~(9)~~(10) **"Physician"** means a doctor of medicine or osteopathy legally authorized to practice medicine and surgery or who is a licensed physician employed by the Federal Government in an IHS facility or who provides services in a 638 Tribal Facility.

~~(10)~~(11) **"State Administering Agency (SAA)"** is the Oklahoma Health Care Authority.

(12) **"Telehealth"** means the practice of health care delivery, diagnosis, consultation, evaluation and treatment, transfer of medical data or exchange of medical education information by means of a two-way, real-time interactive communication, not to exclude store and forward technologies, between a patient and a healthcare provider with access to and reviewing the patient's relevant clinical information prior to the telemedicine visit. Telehealth shall not include consultations provided by telephone audio-only communication, electronic

mail, text message, instant messaging conversation, website questionnaire, nonsecure video conference, or facsimile transmission.

~~(11)~~(13) "**638 Tribal Facility**" is a facility that is operated by a tribe or tribal organization and funded by Title I or Title ~~III~~V of the Indian Self Determination and Education Assistance Act (Public Law 93-638).

317:30-5-1098. I/T/U Indian Health Services, Tribal Programs, and Urban Indian clinics (I/T/Us) outpatient encounters

(a) I/T/U outpatient encounters that are billed to the OHCA must meet the definition in this Section and are limited to services covered by the OHCA. These services include health services included in the State Plan under Title XIX or Title XXI of the Social Security Act.

(1) An I/T/U encounter means a face to face, ~~or a~~ telehealth contact, or an audio-only telecommunications contact between a health care professional and an ~~IHS~~Indian Health Services (IHS) eligible SoonerCare member for the provision of medically necessary Title XIX or Title XXI covered services through an IHS or Tribal 638 facility or an urban Indian clinic within a ~~24-hour~~twenty-four (24) period ending at midnight, as documented in the patient's record.

(2) An I/T/U outpatient encounter means outpatient services that may be covered when furnished to a patient by a contracted SoonerCare provider employed by the I/T/U facility and rendered at the I/T/U facility or other location, including the patient's place of residence.

(b) The following services may be considered reimbursable encounters subject to the limitations of the Oklahoma State Plan and include any related medical supplies provided during the course of the encounter:

- (1) Medical;
- (2) Diagnostic;
- (3) Behavioral Health services [refer to OAC 317:30-5-1094];
- (4) Dental, Medical and Mental Health Screenings;
- (5) Vision;
- (6) Physical Therapy;
- (7) Occupational Therapy;
- (8) Podiatry;
- (9) Speech;
- (10) Hearing;
- (11) Visiting Nurse Service [refer to OAC 317:30-5-1093];
- (12) Smoking and Tobacco Use Cessation Counseling;
- (13) Other Title XIX or XXI services as allowed under OHCA's SoonerCare State Plan and OHCA Administrative Rules;
- (14) Drugs or medication treatments provided during a clinic visit are part of the encounter rate. For example, a member has come into the clinic with high blood pressure and is treated at the clinic with a hypertensive drug or drug sample. Drug samples are included in the encounter rate. Prescription drugs are reimbursed pursuant to OAC 317:30-5-78(b)(4)(B).
- (15) Encounters with a registered professional nurse or a licensed practical nurse and related medical supplies (other than drugs and biologicals) furnished on a part-time or intermittent basis to home-bound members; and
- (16) I/T/U Multiple Outpatient Encounters.

(A) OHCA will cover one medically necessary outpatient medical encounter per member per day unless if due to an emergency, the same member returns on the same day for a

second visit with a different diagnosis. Then, a second encounter is allowed.

(B) OHCA will cover one dental encounter per member per day regardless of how many procedures are done or how many providers are seen unless if due to an emergency, the same member returns on the same day for a second visit and has a different diagnosis. Then, a second encounter is allowed.

(C) OHCA will cover one behavioral health professional outpatient encounter per member per day unless if due to an emergency, the same member returns on the same day for a second visit and has a different diagnosis. Then, a second encounter is allowed.

(D) Each service must have distinctly different diagnoses in order to meet the criteria for multiple I/T/U outpatient encounters.

(c) More than one outpatient visit with a medical professional within a ~~24-hour~~ twenty-four (24) hour period for distinctly different diagnoses may be reported as two encounters. This does not imply that if a member is seen at a single office visit with multiple problems that multiple encounters can be billed. For example, a member comes to the clinic in the morning for an immunization, and in the afternoon, the member falls and breaks an arm. This would be considered multiple medical encounters and can be billed as two encounters. However, a member who comes to the I/T/U facility for a diabetic wellness screening and is then referred to a podiatrist within the clinic for diabetes-related follow-up on the same date of service would not be considered a distinctly different diagnosis and can only be billed as a single encounter.

(d) The following services may be considered as separate or multiple encounters when two or more services are provided on the same date of service with distinctly different diagnoses:

(1) Medical Services;

(2) Dental Services;

(3) Mental Health and addiction services with similar diagnoses can only be billed as one encounter. In addition, if the member is also seen for a medical office visit with a mental health or addiction diagnosis, then it is considered a single encounter;

(4) Physical or occupational therapy (PT/OT). If this service is also performed on the same date of service as the medical encounter that determined the need for PT/OT (initial referral), then it is considered a single encounter;

(5) Administration of immunizations. If no other medical office visit occurs on the same date of services; and

(6) Tobacco cessation limited to state plan services. If no other medical or addiction encounter occurs on the same date of service.

(e) I/T/U outpatient encounters for IHS eligible SoonerCare members whether medical, dental, or behavioral health, are not subject to prior authorization. Other State Plan covered services that the I/T/U facility chooses to provide but which are not part of the I/T/U encounter are subject to all applicable SoonerCare regulations which govern the provision and coverage for that service.

This page intentionally left blank

**TITLE 317. OKLAHOMA HEALTH CARE AUTHORITY
CHAPTER 30. MEDICAL PROVIDERS-FEE FOR SERVICE**

SUBCHAPTER 3. GENERAL PROVIDER POLICIES

PART 3. GENERAL MEDICAL PROGRAM INFORMATION

317:30-3-41. Home and Community Based Services Waivers for persons with physical disabilities

(a) **ADvantage Waiver.** The ADvantage Waiver Program is a Medicaid Home and Community Based Services (HCBS) Waiver used to finance non-institutional long-term care services through Oklahoma's SoonerCare program for elderly and disabled individuals in specific waiver areas. To receive ADvantage Program services, individuals must meet the nursing facility level of care criteria, be age ~~65~~sixty-five (65) years or older, or age ~~21~~nineteen (19) or older if disabled. ADvantage Program members must be SoonerCare eligible and reside in the designated service area. The number of members in the ADvantage Waiver is limited.

(b) **Medically Fragile Waiver.** The Medically Fragile Waiver Program is a Medicaid Home and Community Based Services (HCBS) Waiver used to finance non-institutional long-term care services through Oklahoma's SoonerCare program for medically fragile individuals. To receive Medically Fragile Program services, individuals must be at least 19 years of age, be SoonerCare eligible, and meet the ~~OHCA~~Oklahoma Health Care Authority (OHCA) skilled nursing facility (SNF) or hospital level of care (LOC) criteria. Eligibility does not guarantee placement in the program as Waiver membership is limited.

This page intentionally left blank

**TITLE 317. OKLAHOMA HEALTH CARE AUTHORITY
CHAPTER 35. MEDICAL ASSISTANCE FOR ADULTS AND CHILDREN-
ELIGIBILITY**

SUBCHAPTER 17. ADVANTAGE WAIVER SERVICES

317:35-17-1. Overview of long-term medical care services; relationship to Qualified Medicare Beneficiary Plus (QMBP), Specified Low-Income Medicare Beneficiary (SLMB), and other Medicaid (SoonerCare) services eligibility

(a) Long-term medical care for the categorically needy includes:

- (1) Care in a long-term care facility per Oklahoma Administrative Code (OAC) 317:35-19;
- (2) Care in a public or private intermediate care facility for the intellectually disabled (ICF/IID), per OAC 317:35-9;
- (3) Care of persons sixty-five (65) years of age and older in mental health hospitals, per OAC 317:35-9;
- (4) Home and Community-Based waiver services for persons with intellectual disabilities, per OAC 317:35-9;
- (5) Personal Care services, per OAC 317:35-15; and
- (6) Home and Community-Based waiver services (ADvantage waiver) for frail elderly, sixty-five (65) years of age and older; and a targeted group of adults with physical disabilities, ~~twenty-one (21)~~nineteen (19) to sixty-four (64) years of age and older, who do not have an intellectual disability or a cognitive impairment related to a developmental disability per OAC 317:35-17-3.

(b) When an individual is certified as eligible for SoonerCare coverage of long-term care, he or she is also eligible for other SoonerCare services. ADvantage waiver members do not have a copayment for ADvantage services except for prescription drugs. For members residing in an ADvantage assisted living center, any income beyond one-hundred and fifty percent (150%) of the federal benefit rate is available to defray the cost of the assisted living services received. The member is responsible for payment to the assisted living services center provider for days of service, from the first day of each full-month in which services were received, until the vendor pay obligation is met. When an individual is aged, blind, or disabled and is determined eligible for long-term care, a separate eligibility determination must be made for QMBP or SLMB benefits. An ADvantage program member may reside in a licensed assisted living services center only when the assisted living services center is a certified ADvantage assisted living services center provider from whom the member is receiving ADvantage assisted living services.

317:35-17-3. ADvantage program services

(a) The ADvantage program is a Medicaid Home and Community-Based waiver used to finance non-institutional, long-term care services for the elderly and a targeted group of physically disabled adults when there is a reasonable expectation that within a thirty (30) calendar day period, the person's health, due to disease process or disability, would without appropriate services, deteriorate and require long-term care (LTC) facility care to arrest the deterioration. Individuals may not be enrolled in ADvantage for the sole purpose of enabling them to obtain Medicaid eligibility. Eligibility for ADvantage program services is contingent on an individual requiring one (1) or more of the services offered in the waiver, at least monthly, to avoid institutionalization.

(b) The number of individuals who may receive ADvantage services is limited.

(1) To receive ADvantage program services, individuals must meet one of the categories in (A) through (D) of this paragraph. He or she must:

(A) Be sixty-five (65) years of age or older; or

(B) Be ~~twenty-one (21)~~nineteen (19) to sixty-four (64) years of age with a physical disability; or

(C) Be ~~twenty-one (21)~~nineteen (19) to sixty-four (64) years of age with a developmental disability, provided he or she does not have a cognitive impairment (intellectual disability); or

(D) Be ~~twenty-one (21)~~nineteen (19) to sixty-four (64) years of age with a clinically documented, progressive, degenerative disease process that responds to treatment and previously required hospital or LTC facility level of care services to maintain the treatment regimen to prevent health deterioration.

(2) In addition, the individual must meet criteria in (A) through (C) of this paragraph. He or she must:

(A) Require long-term care facility level of care, per Oklahoma Administrative Code (OAC) 317:35-17-2;

(B) Meet service eligibility criteria, per OAC 317:35-17-3(f); and

(C) Meet program eligibility criteria, per OAC 317:35-17-3(g).

(c) ADvantage members are eligible for limited types of living arrangements. The specific living arrangements are set forth in (1) through (5) of this subsection.

(1) ADvantage program members are not eligible to receive services while residing in an unlicensed institutional living arrangement, such as a room and board home or facility; an institutional setting including, but not limited to, licensed facilities, such as a hospital, a LTC facility, licensed residential care facility, or licensed assisted living facility, unless the facility is an ADvantage assisted living center.

(2) Additional living arrangements in which members may receive ADvantage services are the member's own home, apartment, or independent-living apartment, or a family or friend's home or apartment. A home or apartment unit is defined as a self-contained living space having a lockable entrance to the unit and including a bathroom, food storage and preparation amenities in addition to the bedroom or living space.

(3) ADvantage program members may receive services in a shelter or similar temporary-housing arrangement that may or may not meet the definition of home or apartment in emergency situations, for a period not to exceed sixty (60) calendar days during which location and transition to permanent housing is sought.

(4) For ADvantage members who are full-time students, a dormitory room qualifies as an allowable living arrangement in which to receive ADvantage services while the member is a student.

(5) Members may receive ADvantage respite services in an LTC facility for a continuous period not to exceed thirty (30) calendar days.

(d) Home and Community-Based waiver services are outside of the scope of Medicaid State Plan services. The Medicaid waiver allows the Oklahoma Health Care Authority to offer certain Home and Community-Based services to an annually capped number of persons, who are categorically needy, per Oklahoma Human Services (OKDHS) Appendix C-1, Schedule VIII. B. 1., and without such services would be institutionalized. The estimated cost of providing an individual's care outside of the LTC facility cannot exceed the annual cost of caring for that individual in a LTC facility. When determining the ADvantage service plan cost cap for an individual, the comparable Medicaid cost to serve that individual in a LTC facility is estimated.

(e) Services provided through the ADvantage waiver are:

- (1) Case management;
- (2) Respite;
- (3) Adult day health care;
- (4) Environmental modifications;
- (5) Specialized medical equipment and supplies;
- (6) Physical, occupational, or speech therapy or consultation;
- (7) Advanced supportive and/or restorative assistance;
- (8) Nursing;
- (9) Skilled nursing;
- (10) Home-delivered meals;
- (11) Hospice care;
- (12) Medically necessary prescription drugs, within the limits of the ADvantage waiver;
- (13) Personal care, State Plan, or ADvantage personal care;
- (14) A Personal Emergency Response System (PERS);
- (15) Consumer Directed Personal Assistance Services and Supports (CD-PASS);
- (16) Institution Transition Services (Transitional Case Management);
- (17) Assisted living;
- (18) Remote Supports;
- (19) Assistive technology; and
- (20) SoonerCare medical services for individuals, twenty-one (21) years of age and over, within the State Plan scope.

(f) The OKDHS area nurse or nurse designee determines service eligibility prior to evaluating the Uniform Comprehensive Assessment Tool (UCAT) assessment for long-term care facility level of care. The criteria in (1) through (5) of this subsection are used to make the service eligibility determination, which includes:

- (1) An open ADvantage program waiver slot, as authorized by the Centers for Medicare and Medicaid Services (CMS), is available to ensure federal participation in payment for services to the individual. When Oklahoma Human Services Community Living, Aging and Protective Services (CAP) determines all slots are filled, the individual cannot be certified as eligible for ADvantage services, and his or her name is placed on a waiting list for entry when an open slot becomes available.
- (2) The ADvantage waiver-targeted service groups are individuals, who:
 - (A) Are frail and sixty-five (65) years of age and older; or
 - (B) Are ~~Twenty-one (21)~~nineteen (19) to sixty-four (64) years of age and physically disabled; or
 - (C) When developmentally disabled and ~~twenty-one (21)~~nineteen (19) to sixty-four (64) years of age and do not have an intellectual disability or cognitive impairment related to the developmental disability; or
 - (D) Are ~~twenty-one (21)~~nineteen (19) to sixty-four (64) years of age and not physically disabled but have a clinically documented, progressive, degenerative disease process that responds to treatment and previously required hospital or long-term care facility level of care services to maintain the treatment regimen to prevent health deterioration. The individual must meet criteria, per OAC 317:35-17-3(b)(2)(A) through (C).
- (3) An individual is ineligible when posing a physical threat to self or others, as supported by professional documentation.

(4) An individual is ineligible when members of the household or persons who routinely visit the household pose a threat of harm or injury to the individual or other household visitors, as supported by professional documentation.

(5) An individual is ineligible when his or her living environment poses a physical threat to self or others, as supported by professional documentation where applicable, and measures to correct hazardous conditions or assist the individual to move are unsuccessful or not feasible.

(g) The State, as part of the ADvantage waiver program approval process, ensures CMS that each member's health, safety, or welfare can be maintained in his or her home. When a member's identified needs cannot be met through provision of the ADvantage program or Medicaid State Plan services and other formal or informal services are not in place or immediately available to meet those needs, the individual's health, safety, or welfare in his or her home cannot be ensured. The ADvantage Administration (AA) determines ADvantage program eligibility through the service plan approval process. An individual is deemed ineligible for the ADvantage program based on criteria (1) through (8) of this subsection.

(1) The individual's needs, as identified by the UCAT and other professional assessments, cannot be met through ADvantage program services, Medicaid State Plan services, or other formal or informal services.

(2) One (1) or more members of the individual's household pose a physical threat to themselves, or others as supported by professional documentation.

(3) The individual or other household members use threatening, intimidating, degrading, or use sexually inappropriate language or innuendo or behavior towards service providers, in the home or through other contact or communications, and significant efforts were attempted to correct such behavior, as supported by professional documentation or other credible documentation.

(4) The individual, or the individual's authorized agent, is uncooperative or refuses to participate in service development or service delivery and these actions result in unacceptable increases of risk to the individual's health, safety, or welfare in his or her home, as determined by the individual, the interdisciplinary team, or the AA.

(5) The individual's living environment poses a physical threat to self or others, as supported by professional documentation, and measures to correct hazardous conditions or assist the person to move are unsuccessful or are not feasible.

(6) The individual provides false or materially inaccurate information necessary to determine program eligibility or withholds information necessary to determine program eligibility.

(7) The individual does not require at least one ADvantage service monthly.

(8) The individual, his or her family member(s), associate(s), or any other person(s) or circumstances as relates to care and coordination in the living environment produces evidence of illegal drug activity or substances used illegally as intoxicants. This includes:

(A) The use, possession, or distribution of illegal drugs;

(B) The abusive use of other drugs, such as medication prescribed by a doctor;

(C) The use of substances, such as inhalants including, but not limited to:

(i) Typewriter correction fluid;

(ii) Air conditioning coolant;

(iii) Gasoline;

(iv) Propane;

(v) Felt-tip markers;

(vi) Spray paint;

(vii) Air freshener;

- (viii) Butane;
- (ix) Cooking spray;
- (x) Paint; and
- (xi) Glue;

(D) The observed intoxication, consumption, or sensory indicators, such as smell of the use of any drug or intoxicant by the individual, family members, associates, or any other person(s) present at the time care is provided may be construed as evidence indicative of illegal drug activity or intoxication. This includes drug use or intoxicated activity that is menacing to the member or staff providing services;

(E) The observance of drug paraphernalia or any instrument used in the manufacturing, production, distribution, sale, or consumption of drugs or substances including, but not limited to:

- (i) Smoking pipes used to consume substances other than tobacco;
- (ii) Roach clips containing marijuana cigarettes;
- (iii) Needles and other implements used for injecting drugs into the body;
- (iv) Plastic bags or other containers used to package drugs;
- (v) Miniature spoons used to prepare drugs; or
- (vi) Kits used in the production of synthetic controlled substances including descriptive materials that accompany the item, describing or depicting its use.

(F) Instructions, verbal or written, concerning the item or device including, but not limited to, the manner in which the object is labeled and displayed for sale;

(G) The typical use of such items in the community; or

(H) Testimony of an expert witness regarding use of the item.

(h) The case manager provides the AA with professional documentation or other credible documentation to support the recommendation for redetermination of program eligibility. The service providers continue providing services according to the person-centered service plan as provider safety permits until the individual is removed from the ADvantage program. As a part of the procedures requesting redetermination of program eligibility, CAP provides technical assistance to the provider for transitioning the individual to other services.

(i) Individuals determined ineligible for ADvantage program services are notified in writing by CAP of the determination and of their right to appeal the decision.

This page intentionally left blank

**TITLE 317. OKLAHOMA HEALTH CARE AUTHORITY
CHAPTER 30. MEDICAL PROVIDERS-FEE FOR SERVICE**

SUBCHAPTER 3. GENERAL PROVIDER POLICIES

PART 1. GENERAL SCOPE AND ADMINISTRATION

317:30-3-35. Oklahoma State Health Information Network and Exchange (OKSHINE) Statewide Health Information Exchange

(a) **Authority.** This rule is promulgated under the authority granted in Title 63 of the Oklahoma Statutes Section 1-133 (63 O.S. § 1-133). This Section is intended to be read in conjunction with applicable Oklahoma statutes and federal law.

(b) **Applicability and purpose.**

(1) **Applicability.** This section shall apply to and govern the establishment and operation of the statewide health information exchange (HIE), ~~herein referred to as OKSHINE.~~

(2) **Purpose.** ~~OKSHINE is the state-designated organization that facilitates the exchange of health information to and from authorized individuals and health care organizations in the state for the purpose of improving health outcomes, as per 63 O.S. § 1-133. The Office of the State Coordinator for HIE is the office within the Oklahoma Health Care Authority (OHCA) that holds the power and duty to oversee the state-designated entity (SDE) for HIE.~~

(c) **Definitions.** The following words and terms, when used in this Section, shall have the following meaning, unless the context clearly indicates otherwise:

(1) ~~"OKSHINE" means an organization that oversees, governs, and facilitates health information exchange among health care providers that are not related health care organizations as defined in the Oklahoma Statutes, to improve the security of patient information, coordination of patient care, and the efficiency of health care delivery.~~

(2) ~~"Participant" means an organization, health care practitioner or institution, health plan, or health care clearinghouse who has executed a written participation agreement (PA) and business associate agreement (BAA) with OKSHINE.~~

(3) ~~"Participant agreement" means the agreement between OKSHINE and a participant which authorizes the participant to have access to OKSHINE and outlines the policies and procedures for access, protection, and use of the electronic protected health information.~~

(4) ~~"Oklahoma Statewide Health Information Exchange (OKHIE)" means a certified HIE as referenced in 63 O.S. § 1-133 whose primary business activity is health information exchange.~~

(1) **"Health care provider"** means any public or private organization, corporation, authority, partnership, sole proprietorship, association, agency, network, joint venture, or other entity that is established and licensed, certified, or otherwise authorized by the laws of this state to administer health care in the ordinary course of business or practice of a profession and/or employs licensed health care workers in the State of Oklahoma. Health care provider includes but is not limited to facilities such as: ambulatory surgery centers, clinics, home care agencies, hospices, hospitals, intermediate care facilities, laboratories, long-term care agencies, medical centers, mental health and substance use disorder treatment centers, nursing homes, PACE centers, pharmacies, physicians' offices, psychiatric hospitals, public health clinics, and rehabilitation centers.

(2) **"Health Information Exchange (HIE)"** means the electronic movement of health-related

information among organizations according to nationally recognized standards for purposes including, but not limited to payment, treatment, and administration.

(3) "Health information exchange organization" means an entity whose primary business activity is health information exchange and which is governed by its stakeholders.

(4) "OKSHINE" means the Oklahoma Statewide Health Information Network and Exchange, a collective effort of the Office of the State Coordinator and SDE in support of statewide health information exchange.

(5) "Report data to" means that health care providers shall establish a direct, secure connection to the state designated entity for HIE and submit data according to the United States Core Data for Interoperability (USCDI) standard. The form and format are further defined in the specifications on the OKSHINE website. Providers shall transmit data types they collect within their Electronic Health Record, with the exception of any data that: 1) the provider determines to be sensitive patient information that is to be suppressed from transmission to the SDE; 2) is subject to a patient's request for exclusion, consistent with a provider-implemented policy; or 3) such transmission would violate state or federal law or regulation.

(6) "State designated entity (SDE)" means the health information exchange organization designated by the State of Oklahoma. The name and contact information for the state designated entity for HIE is found on the OKSHINE website.

(7) "Utilize" means to actively use the HIE services to securely access records during and/or in support of patient treatment or health care operations.

~~(d) **OKHIE Certification.** Per 63 O.S. '1-133, an initial certification and an annual recertification will be required for health information exchanges to qualify as an OKHIE. In order to receive certification, the applying HIE must submit an application to the Oklahoma Health Care Authority (OHCA) and provide all requested documentation. The application and standards for certification shall be posted on the OHCA OKSHINE public website.~~

~~(1) The OHCA shall establish a health information exchange certification with input from stakeholders.~~

~~(2) Until such time as the health information exchange certification is established by the OHCA, an OKSHINE or an HIE organization that was previously certified by the Oklahoma Health Information Exchange Trust (OHJET) shall be deemed an OKHIE.~~

~~(3) An HIE must provide documentation of certification from OHJET to OHCA in order to receive initial OKHIE certification.~~

~~(e) **Fees.**~~

~~(1) **Certification fees.** Each health information exchange which applies for certification, will be required to pay annual certification/recertification fees. The OHCA will develop the certification criteria and will publish the criteria and associated fees, when available, on the OHCA OKSHINE public website.~~

~~(2) **Participant fees.** Each participant, as defined in this section, will be required to pay an annual participation fee as outlined in the participant agreement. The OHCA will develop the criteria for the fees and will publish the criteria when available. The participant agreement and fee schedule will be posted on the OHCA OKSHINE public website.~~

~~(d) **Required participation.**~~

~~(1) All health care providers as defined above and who are licensed by and located in the state of Oklahoma and are not otherwise exempted, shall submit an application to report data to and~~

utilize the SDE. Providers may register for an exemption from required participation as specified in paragraph (f) of this Section.

(2) Paragraph (d) of this Section shall not apply to:

(A) A health care provider that does not currently own or subscribe to an electronic health records technology system or service.

(B) Health care providers classified as substance abuse treatment facilities covered by 42 Code of Federal Regulations (CFR) Part 2.

(3) Patient-specific protected health information requiring patient consent prior to disclosure, shall only be disclosed in compliance with relevant state or federal privacy laws, rules, regulations, or policies including, but not limited to, the Health Insurance Portability and Accountability Act of 1996, and any laws that require patient consent prior to sharing health information.

(4) The state acknowledges that establishing the connection to the HIE can take substantial time to complete. A health care provider will be considered to have met the requirement to report data to the SDE as long as the provider is actively engaged with the HIE in the onboarding process of connecting to the HIE, and as reported by the SDE.

(5) In order to meet the requirement to utilize the SDE, each health care provider shall secure access to HIE services by the following:

(A) Completing and maintaining an active participation agreement with the SDE for HIE;

(B) Executing annually an order form electing at a minimum the set of core services relevant to the provider practice or organization; and

(C) Maintaining good standing as a participating organization in the SDE for HIE by remaining compliant with the terms and conditions, network policies and procedures, and paying all fees associated with the services elected on the order form.

(e) Fees.

(1) **Subscription fees.** Health care providers as defined in this section are required to subscribe and to pay a subscription fee directly to the SDE on a monthly or annual basis. Subscription fees are determined based on the organization type and size. Subscription fee schedule is established by the SDE based on network operating costs as approved by the SDE board and can be obtained upon request to the SDE. The Office of the State Coordinator for HIE shall receive notice from the SDE of the established subscription fee schedule or changes to the fee schedule no later than ninety (90) days prior to the effective date.

(2) **Connection fees.** Health care providers as defined in this section are required to connect their electronic health record to the SDE to securely report data to the HIE. This is a variable one-time fee paid to the SDE. The Office of the State Coordinator for HIE shall receive notice of connection fees established by the SDE no later than thirty (30) days of being established.

(3) **Grant funds.** Health care providers may apply for a grant to cover connection fees subject to the availability of funds. Grant fees for connection will be paid directly to the SDE on behalf of the provider. Information on grant eligibility can be found on OKSHINE website.

(f) Exemptions.

(1) Any health care provider as defined in paragraph (c) of this section may register an exemption from reporting data to the SDE and/or utilizing the HIE on the OKSHINE website by registering an exemption with the Office of the State Coordinator for HIE.

(2) All providers that register an exemption shall be granted such exemption and shall not be subject to pay subscription fees and/or connection fees.

(3) The exemption will automatically renew annually unless the provider withdraws their exemption and elects to participate.

**TITLE 317. OKLAHOMA HEALTH CARE AUTHORITY
CHAPTER 30. MEDICAL PROVIDERS-FEE FOR SERVICE**

SUBCHAPTER 5. INDIVIDUAL PROVIDERS AND SPECIALTIES

PART 51. HABILITATION SERVICES

317:30-5-482. Description of services

Habilitation services include the services identified in (1) through (15) of this Section. Habilitation services providers must have an applicable agreement with the Oklahoma Health Care Authority (OHCA) to provide Developmental Disabilities Services (DDS) through Home and Community-Based Services (HCBS).

(1) **Dental services.** Dental services are provided per Oklahoma Administrative Code (OAC) 317:40-5-112.

(A) **Minimum qualifications.** Dental services providers must have non-restrictive licensure by the Oklahoma State Board of Dentistry to practice dentistry in Oklahoma.

(B) **Description of services.** Dental services include services for maintenance or improvement of dental health as well as relief of pain and infection. These services may include:

- (i) Oral examinations;
- (ii) Medically necessary images;
- (iii) Prophylaxis;
- (iv) Flouride application;
- (v) Development of a sequenced treatment plan that prioritizes:
 - (I) Pain elimination;
 - (II) Adequate oral hygiene; and
 - (III) Restoring or improving ability to chew;
- (vi) Routine training of member or primary caregiver regarding oral hygiene; and
- (vii) Preventive, restorative, replacement, and repair services to achieve or restore functionality provided after appropriate review when applicable, per OAC 317:40-5-112.

(C) **Coverage limitations.** Dental service coverage is specified in the member's Individual Plan (IP) in accordance with applicable Waiver limits. Cosmetic dental services are not authorized.

(2) **Nutrition services.** Nutrition Services are provided, per OAC 317:40-5-102.

(3) **Occupational therapy services.**

(A) **Minimum qualifications.** Occupational therapists and occupational therapy assistants have current, non-restrictive licensure by the Oklahoma Board of Medical Licensure and Supervision. Occupational therapy assistants are supervised by occupational therapists, per OAC 317:30-5-295 (b) (1).

(B) **Service description.** Occupational therapy services include evaluation, treatment, and consultation in leisure management, daily living skills, sensory motor, perceptual motor, mealtime assistance, assistive technology, positioning, and mobility. Occupational therapy services may include occupational therapy assistants, within the limits of the occupational therapist's practice.

(i) Services are:

- (I) Intended to help the member achieve greater independence to reside and

participate in the community; and

(II) Rendered in any community setting as specified in the member's IP. The IP includes a practitioner's prescription.

(ii) For this Section's purposes, a practitioner means medical and osteopathic physicians, physician assistants, and other licensed health care professionals with prescriptive authority to order occupational therapy services in accordance with the rules and regulations governing the SoonerCare program.

(iii) Service provision includes a written report or record documentation in the member's record, as required.

(C) **Coverage limitations.** For compensable services, payment is made to the individual occupational therapist for direct services or for services provided by a qualified occupational therapist assistant within the occupational therapist's employment. Payment is made in fifteen-minute (15-minute) units, with a limit of four hundred and eighty (480) units per Plan of Care (POC) year. Payment is not allowed solely for written reports or record documentation.

(4) **Physical therapy services.**

(A) **Minimum qualifications.** Physical therapists and physical therapist assistants must have current, non-restrictive licensure with the Oklahoma Board of Medical Licensure and Supervision. The physical therapist supervises the physical therapist assistant, per OAC 317:30-5-290.1 (b) (1).

(B) **Service description.** Physical therapy services include evaluation, treatment, and consultation in locomotion or mobility skeletal and muscular conditioning, assistive technology, and positioning to maximize the member's mobility and skeletal/muscular well-being. Physical therapy services may include physical therapist assistants, within the limits of the physical therapist's practice.

(i) Services are intended to help the member achieve greater independence to reside and participate in the community. Services are provided in any community setting as specified in the member's IP. The IP includes a practitioner's prescription. For this Section's purposes, practitioners are defined as licensed medical and osteopathic physicians and physician assistants in accordance with the rules and regulations covering the OHCA SoonerCare program.

(ii) Service provision includes a written report or record documentation in the member's record, as required.

(C) **Coverage limitations.** For compensable services, payment is to individual physical therapists for direct services or for services provided by a qualified physical therapist assistant within the physical therapist's employment. Payment is made in fifteen-minute (15-minute) units with a limit of four hundred and eighty (480) units per POC. Payment is not allowed solely for written reports or record documentation.

(5) **Psychological services.**

(A) **Minimum qualifications.** Qualification to provide psychological services requires current, non-restrictive licensure as a psychologist by the Oklahoma State Board of Examiners of Psychologists, or by the licensing board in the state where the service is provided. Psychological technicians who have completed all board certification and training requirements may provide services under a licensed psychologist's supervision.

(B) **Service description.** Psychological services include evaluation, psychotherapy, consultation, and behavioral treatment. Service is provided in any community setting as specified in the member's IP. The provider develops, implements, evaluates, and revises

the Protective Intervention Protocol (PIP) corresponding to the relevant outcomes identified in the member's IP.

(i) Services are:

(I) Intended to maximize a member's psychological and behavioral well-being; and

(II) Provided in individual and group formats, with a six-person maximum.

(ii) Service approval is based on assessed needs per OAC 340:100-5-51.

(C) Coverage limitations.

(i) Payment is made in fifteen (15) minute units. A minimum of fifteen (15) minutes for each individual and group encounter is required.

(ii) Psychological services are authorized for a period, not to exceed twelve (12) months.

(I) Initial authorization does not exceed one hundred and ninety-two (192) units, forty-eight (48) service hours.

(II) Authorizations may not exceed two hundred and eighty-eight (288) units per POC year unless the DDS Behavior Support Services director or designee makes an exception.

(III) No more than twelve (12) hours of services, forty-eight (48) units, may be billed for PIP preparation. Any clinical document is prepared within sixty (60) calendar days of the request. Further, if the document is not prepared, payments are suspended until the requested document is provided.

(IV) When revising a PIP to accommodate recommendations of a required committee review, the provider may bill for only one (1) revision. The time for preparing the revision is clearly documented and does not exceed four (4) hours.

(6) Psychiatric services.

(A) **Minimum qualifications.** Qualification as a psychiatric services provider requires a current, non-restrictive license to practice medicine in Oklahoma. Certification by the American Board of Psychiatry and Neurology or satisfactory completion of an approved residency program in psychiatry is required.

(B) **Service description.** Psychiatric services include outpatient evaluation, psychotherapy, medication and prescription management and consultation, and are provided to eligible members. Services are provided in the community setting specified in the member's IP.

(i) Services are intended to contribute to the member's psychological well-being.

(ii) A minimum of thirty (30) minutes for encounter and record documentation is required.

(C) **Coverage limitations.** A unit is thirty (30) minutes, with a limit of two hundred (200) units, per POC year.

(7) Speech-language pathology services.

(A) **Minimum qualifications.** Qualification as a speech-language pathology services provider requires current, non-restrictive licensure as a speech-language pathologist, speech-language pathology assistant, or speech-language pathology clinical fellow, by the Oklahoma Board of Examiners for Speech-Language Pathology and Audiology, per OAC 317:30-5-675.

(B) **Service description.** Speech therapy includes evaluation, treatment, and consultation in communication, oral motor activities, and/or feeding activities provided to eligible members. Services are intended to maximize the member's community living skills and

may be provided in the community setting specified in the member's IP.

(i) The IP includes a practitioner's prescription. For this Section's purposes, practitioners are defined as licensed medical and osteopathic physicians, physician assistants, and other licensed professionals with prescriptive authority to order speech or language services or both in accordance with rules and regulations covering the OHCA SoonerCare program.

(ii) A minimum of fifteen (15) minutes for encounter and record documentation is required.

(C) **Coverage limitations.** A unit is fifteen (15) minutes, with a limit of two hundred and eighty-eight (288) units, per POC. Payment is not allowed solely for written reports or record documentation.

(8) Habilitation training specialist (HTS) services.

(A) **Minimum qualifications.** Providers complete Oklahoma Human Services (OKDHS) DDS-sanctioned training curriculum. Residential habilitation providers:

(i) Are at least eighteen (18) years of age or older;

(ii) Are specifically trained to meet members' unique needs;

(iii) Have not been convicted of, pled guilty to, or pled nolo contendere to misdemeanor assault and battery, or a felony, per Section (§) 1025.2 of Title 56 of the Oklahoma Statutes (56 O.S. § 1025.2) unless a waiver is granted, per 56 O.S. §1025.2; and

(iv) Receive supervision and oversight from contracted-agency staff with a minimum of four (4) years of any combination of college-level education or full-time equivalent experience in serving persons with disabilities.

(B) **Service description.** HTS services include services to support the member's self-care, daily living, and adaptive and leisure skills needed to reside successfully in the community. Services are provided in community-based settings in a manner that contributes to the member's independence, self-sufficiency, community inclusion, and well-being.

(i) Payment is not made for:

(I) Routine care and supervision family normally provides; or

(II) Services furnished to a member by a person who is legally responsible, per OAC 340:100-3-33.2.

(ii) Family members who provide HTS services meet the same standards as providers who are unrelated to the member. HTS staff residing in the same household as the member may not provide services in excess of forty (40) hours per week. Members who require HTS services for more than forty (40) hours per week use staff members who do not reside in the household, and who are employed by the member's chosen provider agency, to deliver the balance of necessary support staff hours. Exceptions may be authorized, when needed, for members who receive services through the Homeward Bound Waiver.

(iii) Payment does not include room and board or maintenance, upkeep, or improvement of the member's or family's residence.

(iv) For members who also receive intensive personal supports (IPS), the member's IP clearly specifies the role of the HTS and person providing IPS to ensure there is no service duplication.

(v) Review and approval by the DDS plan of care reviewer is required.

(vi) Pre-authorized HTS services accomplish the same objectives as other HTS

services, but are limited to situations where the HTS provider is unable to obtain required professional and administrative oversight from an OHCA-approved oversight agency. For pre-authorized HTS services, the service:

(I) Provider receives DDS area staff oversight; and

(II) Is pre-approved by the DDS director or his or her designee.

(C) **Coverage limitations.** HTS services are authorized per OAC 317:40-5-110, 317:40-5-111, 317:40-7-13, and 340:100-3-33.1.

(i) A unit is fifteen (15) minutes.

(ii) Individual HTS service providers are limited to a maximum of forty (40) hours per week regardless of the number of members served.

(iii) More than one (1) HTS may provide care to a member on the same day.

(iv) Payment cannot be made for services provided by two (2) or more HTSs to the same member during the same hours of a day.

(v) An HTS may receive reimbursement for providing services to only one (1) member at any given time. This does not preclude services from being provided in a group setting where services are shared among group members.

(vi) HTS providers may not perform any job duties associated with other employment including on-call duties, at the same time they are providing HTS services.

(9) **Remote Supports (RS).** RS is provided per OAC 317:40-4-4.

(10) **Self Directed HTS (SD HTS).** SD HTS are provided per OAC 317:40-9-1.

(11) **Self Directed Goods and Services (SD GS).** SD GS are provided per OAC 317:40-9-1.

(12) **Audiology services.**

(A) **Minimum qualifications.** Audiologists have licensure as an audiologist by the Oklahoma Board of Examiners for Speech Pathology and Audiology per OAC 317:30-5-675 (d) (1).

(B) **Service description.** Audiology services include individual evaluation, treatment, and consultation in hearing to eligible members. Services are intended to maximize the member's auditory receptive abilities.

(i) The member's IP includes a practitioner's prescription. For this Section's purposes, practitioners are defined as licensed medical and osteopathic physicians, and physician assistants in accordance with OAC 317:30-5-1 covering the OHCA SoonerCare program.

(ii) A minimum of fifteen (15) minutes for encounter and record documentation is required.

(C) **Coverage limitations.** Audiology services are provided in accordance with the member's IP.

(13) **Prevocational services.**

(A) **Minimum qualifications.** Prevocational services providers:

(i) Are eighteen (18) years of age or older;

(ii) Complete OKDHS DDS-sanctioned training curriculum;

(iii) Are not convicted of, pled guilty to, or pled nolo contendere to misdemeanor assault and battery, or a felony per 56 O.S. § 1025.2, unless a waiver is granted per 56 O.S. § 1025.2; and

(iv) Receive supervision and oversight from a person with a minimum of four (4) years of any combination of college-level education or full-time equivalent

experience in serving persons with disabilities.

(B) **Service description.** Prevocational services are not available to persons who can be served under a program funded per Section 110 of the Rehabilitation Act of 1973 or the Individuals with Disabilities Education Act (IDEA) per Section 1401 et seq. of Title 20 of the United States Code.

(i) Prevocational services are learning and work experiences where the member can develop general, non-job, task-specific strengths that contribute to employability in paid employment in integrated community settings.

(ii) Activities include teaching concepts such as communicating effectively with supervisors, co-workers, and customers, attendance, task completion, problem solving, and safety. These activities are associated with building skills necessary to perform work.

(iii) Pre-vocational services are delivered to further habilitation goals that lead to greater opportunities for competitive, integrated employment. All prevocational services are reflected in the member's IP. Documentation is maintained in the record of each member receiving this service, noting the service is not otherwise available through a program funded under the Rehabilitation Act of 1973 or IDEA.

(iv) Services include:

(I) Center-based prevocational services, per OAC 317:40-7-6;

(II) Community-based prevocational services per, OAC 317:40-7-5;

(III) Enhanced community-based prevocational services per, OAC 317:40-7-12;
and

(IV) Supplemental supports, as specified in OAC 317:40-7-13.

(C) **Coverage limitations.** A unit of center-based or community-based prevocational services is one (1) hour and payment is based on the number of hours the member participates in the service. All prevocational services and supported-employment services combined may not exceed the annual costs set forth in OKDHS Appendix D-26, Developmental Disabilities Services Rates Schedule. The services that may not be provided to the same member at the same time as prevocational services are:

(i) HTS;

(ii) IPS;

(iii) ~~Adult Day Services~~ Adult Day Health ??????????;

(iv) Daily Living Supports (DLS);

(v) Homemaker; or

(vi) Therapy services, such as occupational therapy; physical therapy; nutrition, speech, or psychological services; family counseling; or family training, except to allow the therapist to assess the individual's needs at the workplace or to provide staff training, per OAC 317:40-7-6.

(14) **Supported employment.**

(A) **Minimum qualifications.** Supported employment providers:

(i) Are eighteen (18) years of age or older;

(ii) Complete the OKDHS DDS-sanctioned training curriculum;

(iii) Are not convicted of, pled guilty to, or pled nolo contendere to misdemeanor assault and battery, or a felony, per 56 O.S. § 1025.2 unless a waiver is granted, per 56 O.S. § 1025.5; and

(iv) Receive supervision and oversight from a person with a minimum of four (4) years of any combination of college-level education or full-time equivalent

experience in serving persons with disabilities.

(B) Services description. For members receiving HCBS Waiver services, supported employment is conducted in various settings, particularly worksites where persons without disabilities are employed, and includes activities that are outcome based and needed to sustain paid work, including supervision and training. The supported employment outcome is sustained paid employment at or above minimum wage, but not less than the customary wage and benefit level the employer pays for the same or similar work individuals without disabilities perform. The paid employment occurs in an integrated setting in the general workforce in a job that meets personal and career goals.

(i) When supported-employment services are provided at a worksite where persons without disabilities are employed, payment:

(I) Is made for the adaptations, supervision, and training members require as a result of their disabilities; and

(II) Does not include payment for the supervisory activities rendered as a normal part of the business setting.

(ii) Services include:

(I) Job coaching per OAC 317:40-7-7;

(II) Enhanced job coaching per OAC 317:40-7-12;

(III) Employment training specialist services per OAC 317:40-7-8; and

(IV) Stabilization per OAC 317:40-7-11.

(iii) Supported-employment services furnished under HCBS Waivers are not available under a program funded by the Rehabilitation Act of 1973 or IDEA.

(iv) Documentation that the service is not otherwise available under a program funded by the Rehabilitation Act of 1973 or IDEA is maintained in each member's record.

(v) Federal financial participation may not be claimed for incentive payment subsidies or unrelated vocational training expenses, such as:

(I) Incentive payments made to an employer to encourage or subsidize the employer's participation in a supported employment program;

(II) Payments passed through to users of supported-employment programs; or

(III) Payments for vocational training not directly related to a member's supported-employment program.

(C) Coverage limitations. A unit is fifteen (15) minutes and payment is made per OAC 317:40-7-1 through 317:40-7-21. All prevocational services and supported-employment services combined cannot exceed \$27,000, per POC year. The DDS case manager assists the member to identify other alternatives to meet identified needs above the limit. The services that may not be provided to the same member, at the same time as supported-employment services are:

(i) HTS;

(ii) IPS;

(iii) ~~Adult Day Services~~ Adult Day Health ?????;

(iv) DLS;

(v) Homemaker; or

(vi) Therapy services, such as occupational therapy; physical therapy; nutrition, speech, or psychological services, family counseling, or family training, except to allow the therapist to assess the individual's needs at the workplace or to provide staff training.

(15) **IPS.**

(A) **Minimum qualifications.** IPS provider agencies must have a current provider agreement with OHCA and OKDHS DDS. Providers:

- (i) Are eighteen (18) years of age or older;
- (ii) Complete OKDHS DDS-sanctioned training curriculum;
- (iii) Are not convicted of, pled guilty to, or pled nolo contendere to misdemeanor assault and battery, or a felony, per 56 O.S. § 1025.2 unless a waiver is granted, per 56 O.S. § 1025.2;
- (iv) Receive supervision and oversight from a person with a minimum of four (4) years of any combination of college-level education or full-time equivalent experience in serving persons with disabilities; and
- (v) Receive oversight regarding specific methods to be used with the member to meet the member's complex behavioral or health support needs.

(B) **Service description.**

(i) IPS:

- (I) Are support services provided to members who need an enhanced level of direct support in order to successfully reside in a community-based setting; and
- (II) Build on the support level HTS or DLS staff provides by utilizing a second staff person on duty to provide assistance and training in self-care, daily living, and recreational and habilitation activities.

(ii) The member's IP clearly specifies the role of HTS and the person providing IPS to ensure there is no service duplication.

(iii) The DDS POC reviewer is required to review and approve services.

(C) **Coverage limitations.** IPS are limited to twenty-four (24) hours per day and are included in the member's IP, per OAC 317:40-5-151 and 317:40-5-153.

(16) **Adult day services**~~Adult day health (ADH).~~

(A) **Minimum qualifications.** ~~Adult day service~~Adult day health (ADH) provider agencies:

- (i) Meet licensing requirements, per 63 O.S. § 1-873 *et seq.* and comply with OAC 310:605; and
- (ii) Are approved by the OKDHS DDS director and have a valid OHCA contract for ~~adult day services~~ADH.

(B) **Service description.** ~~Adult day services~~ADH provide assistance with retaining or improving the member's self-help ability adaptive and socialization skills, including the opportunity to interact with peers in order to promote a maximum level of independence and function. Services are provided in a non-residential setting away from the home or facility where the member resides.

(C) **Coverage limitations.** ~~Adult day services~~ADH ~~are~~is furnished four (4) or more hours per day on a regularly scheduled basis, for one (1) or more days per week. A unit is fifteen (15) minutes for up to a maximum of ~~six (6)~~eight (8) hours daily, ~~at which point a unit is~~ ~~one (1) day~~. All services are authorized in the member's IP.

**TITLE 317. OKLAHOMA HEALTH CARE AUTHORITY
CHAPTER 30. MEDICAL PROVIDERS-FEE FOR SERVICE**

SUBCHAPTER 5. INDIVIDUAL PROVIDERS AND SPECIALTIES

PART 79. DENTISTS

317:30-5-700.1. Orthodontic prior authorization

(a) Orthodontic services are available for members who are SoonerCare-eligible and under eighteen (18) years of age, at the time the request for prior authorization for treatment is received, per Oklahoma Administrative Code 317:30-5-700. The following records and documentation, plainly labeled with the member's full name, recipient identification number (RID), and the orthodontist's name are required for prior authorization of orthodontic services and must be electronically submitted to the Dental Unit of the Oklahoma Health Care Authority (OHCA) Dental Program when the member has a total score of not less than thirty (30) points or meets other eligibility criteria in paragraph (d).

- (1) Completed prior authorization requesting all needed treatments;
- (2) Complete and scored Handicapping Labio-Lingual Deviation (~~HDL~~)(HLD) Index with Diagnosis of Angle's classification;
- (3) Detailed description of any oral maxillofacial anomaly;
- (4) Estimated length of treatment;
- (5) Intraoral photographs showing teeth in centric occlusion and/or photographs of trimmed anatomically occluded diagnostic casts. A lingual view of casts may be included to verify impinging overbites;
- (6) Cephalometric images with tracing, and panoramic film, with a request for prior authorization of comprehensive orthodontic treatment;
- (7) Completed OHCA caries risk assessment form;
- (8) If diagnosed as a surgical case, submit an oral surgeon's written opinion that orthognathic surgery is indicated and the surgeon is willing to provide this service; and
- (9) Additional pertinent information as determined necessary by the orthodontist or as requested by the OHCA.

(b) All images and required documentation must be submitted electronically in one (1) package. ~~OHCA is not responsible for lost or damaged materials.~~

(c) All records and documentation submitted in a request for prior authorization for orthodontic treatment are reviewed by the OHCA orthodontic consultant for compensability and length of treatment. ~~Any documentation on which a decision is made will not be returned.~~

(d) Some children not receiving a minimum score of thirty (30) on the ~~HDL~~HLD Index may have other conditions to be considered. In the event an orthodontist believes there are other medical, social, or emotional conditions impacting the general health of the child, he/she refers to the conditions listed on the Early and Periodic Screening, Diagnostic and Treatment (EPSDT) exception section found on the HLD. The following guidelines and restrictions apply to other conditions:

- (1) Other medical, social, or emotional conditions are limited to those conditions that affect the medical, social or emotional function of the child;
- (2) Other medical, social, or emotional conditions are not scored if the sole condition sought to be improved is the cosmetic appearance of the child;

- (3) Such other medical, social, or emotional conditions must be demonstrated by objective evidence such as supported documentation outside the child's immediate family (e.g., a child's teacher, primary care physician, behavioral health provider, school counselor);
 - (4) Objective evidence must be submitted with the HLD;
 - (5) When such other medical, social, or emotional conditions are reflected on the HLD, the OHCA orthodontic consultant must review the data and use his or her professional judgment to score the value of the conditions; and
 - (6) The OHCA orthodontic consultant may consult with and utilize the opinion of the orthodontist who completes the form.
- (e) If it is determined that the malocclusion is not severe enough to warrant medically necessary orthodontic services or the member's age precludes approval, a computer generated notice is issued to the provider and member with notice of the denial, the reason for the denial, and appeal rights [see Oklahoma Administrative Code (OAC) 317:2-1 for grievance procedures and processes].
- (f) Orthodontic treatment and payment for the services are approved within the scope of the SoonerCare program. If orthodontic treatment is approved, a computer generated notice is issued authorizing the first year of treatment.
- (1) Approval of orthodontic treatment is given in accordance with the following:
 - (A) Authorization for the first ~~year~~ twelve (12) months of comprehensive orthodontic care begins on the date of banding and includes the placement of appliances, arch wires, and a minimum of six (6) adjustments. It is expected that orthodontic members be seen every four (4) to eight (8) weeks for the duration of active treatment.
 - (B) ~~Subsequent adjustments will be authorized in one (1) year intervals and the treating orthodontist must provide a comprehensive progress report at the twenty four (24) month interval. Subsequent treatment will be authorized quarterly for the next three (3) quarters. The treating orthodontist must provide a comprehensive progress report for consideration for the fourth and final quarterly approval.~~
 - (C) ~~All approved treatment is included on the original prior authorization and will include the total payment for that treatment year.~~
 - (2) Claim and payment are made as follows:
 - (A) Payment for comprehensive treatment includes the banding, wires, adjustments as well as all ancillary services, lost or broken bracket replacement, including the removal of appliances, and the construction and placing of retainers.
 - (B) ~~Payment is not made for comprehensive treatment beyond thirty six (36) months. Payment for comprehensive treatment is considered paid in full at twenty-four (24) months regardless of treatment length.~~
- (g) If the member moves from the geographic area or shows a need to change their provider, then the provider who received the ~~yearly~~ first year payment is financially responsible until completion of that member's orthodontic treatment for the current year.
- (h) If the provider who received ~~yearly~~ the first year payment does not agree to be financially responsible, then the OHCA may recoup funds paid for the member's orthodontic treatment.
- (i) All orthodontic services are subject to post-utilization review. This review may include a request by the OHCA to submit medical documentation necessary to complete the review. After review is completed, these materials are returned to the orthodontist.
- (j) Electronic images of casts and/or oral/facial images may be requested by OHCA or representatives of OHCA. Providers will be reimbursed for either the study model or images when obtained for orthodontic evaluation and/or therapy.

- (1) Documentation of casts and/or photographic images must be kept in the client's medical record and medical necessity identified on the submitted electronic claim.
- (2) For photographic images, the oral/facial portfolio must include a view of the complete lower arch, complete upper arch, and left and right maximum intercuspation of teeth.
 - (A) Maximum intercuspation refers to the occlusal position of the mandible in which the cusps of the teeth of both arches fully interpose themselves with the cusps of the teeth of the opposing arch.
 - (B) Intercuspation defines both the anterior-posterior and lateral relationships of the mandible and the maxilla, as well as the superior-inferior relationship known as the vertical dimension of occlusion.
- (3) 3-D model images or photographic images not in compliance with the diagnostic guidelines will not be compensable. The provider may be allowed to resubmit new images that adhere to the diagnostic guidelines. If the provider does not provide appropriate documentation, the request for treatment will be denied.

317:30-5-704. Billing instructions

- (a) **HCPCS Codes.** The Oklahoma Health Care Authority (OHCA) utilizes the Medicare Level II Healthcare Common Procedure Coding System (HCPCS) codes. All claim submissions must be in compliance with this coding system.
- (b) **Prior authorization.** Where applicable, the appropriate arch, quadrant, or tooth surface and tooth number must be included on the claim. Diagnosis codes are requested to be listed in ~~box 34 of the current American Dental Association (ADA) dental claim form.~~ For mailed prior authorizations, a completed HCA 13D form is required. the appropriate field when submitting prior authorizations on the provider portal.
- (c) **Images.** Any type of film or prints submitted will not be returned. All images must be dated, mounted and have patient's name, recipient identification number (RID), provider name and provider number.

This page intentionally left blank

**TITLE 317. OKLAHOMA HEALTH CARE AUTHORITY
CHAPTER 30. MEDICAL PROVIDERS FEE FOR SERVICE**

SUBCHAPTER 3. GENERAL PROVIDER POLICIES

PART 3. GENERAL MEDICAL PROGRAM INFORMATION

317:30-3-57. General SoonerCare coverage - categorically needy

The following are general SoonerCare coverage guidelines for the categorically needy:

- (1) Inpatient hospital services.
 - (A) Adult coverage for inpatient hospital stays as described at Oklahoma Administrative Code (OAC) 317:30-5-41.
 - (B) Coverage for members under twenty-one (21) years of age is not limited. All admissions must be medically necessary. All psychiatric admissions require prior authorization for an approved length of stay.
- (2) Emergency department services.
- (3) Dialysis in an outpatient hospital or freestanding dialysis facility.
- (4) Outpatient therapeutic radiology or chemotherapy for proven malignancies or opportunistic infections.
- (5) Outpatient surgical services - facility payment for selected outpatient surgical procedures to hospitals which have a contract with the Oklahoma Health Care Authority (OHCA).
- (6) Outpatient mental health services for medical and remedial care including services provided on an outpatient basis by certified hospital-based facilities that are also qualified mental health clinics.
- (7) Rural health clinic services and other ambulatory services furnished by rural health clinic.
- (8) Optometrists' services - only as listed in Subchapter 5, Part 45, Optometrist specific rules of this Chapter.
- (9) Maternity clinic services.
- (10) Outpatient diagnostic x-rays and lab services. Other outpatient services provided to adults, not specifically addressed, are covered only when prior authorized by the Agency's Medical Authorization Unit.
- (11) Medically necessary screening mammography. Additional follow-up mammograms are covered when medically necessary.
- (12) Long-term care facility services (other than services in an institution for tuberculosis or mental diseases).
- (13) Early and Periodic Screening, Diagnostic and Treatment Services (EPSDT) are available for members under twenty-one (21) years of age to provide access to regularly scheduled examinations and evaluations of the general physical and mental health, growth, development, and nutritional status of infants, children, and youth. Federal regulations also require that diagnosis and treatment be provided for conditions identified during a screening whether or not they are covered under the State Plan, as long as federal funds are available for these services. These services must be necessary to ameliorate or correct defects and physical or mental illnesses or conditions and require prior authorization. EPSDT/OHCA child-health services are outlined in OAC 317:30-3-65.2 through 317:30-3-65.12.
 - (A) EPSDT screening examinations for eligible children by a medical or osteopathic physician, physician assistant, or advanced practice nurse practitioner.

- (B) Diagnostic x-rays, lab, and/or injections when prescribed by a provider.
 - (C) Immunizations.
 - (D) Outpatient care.
 - (E) Dental services as outlined in OAC 317:30-3-65.8.
 - (F) Optometrists' services. The EPSDT periodicity schedule provides for at least one (1) visual screening and glasses each twelve (12) months. In addition, payment is made for glasses for children with congenital aphakia or following cataract removal. Interperiodic screenings and glasses at intervals outside the periodicity schedule for optometrists are allowed when a visual condition is suspected. Payment is limited to two (2) glasses per year. Any glasses beyond this limit must be prior authorized and determined to be medically necessary.
 - (G) Hearing services as outlined in OAC 317:30-3-65.9.
 - (H) Prescribed drugs.
 - (I) Outpatient psychological services as outlined in OAC 317:30-5-275 through 317:30-5-278.
 - (J) Inpatient psychiatric services as outlined in OAC 317:30-5-94 through 317:30-5-97.
 - (K) Transportation. Provided when necessary in connection with examination or treatment when not otherwise available.
 - (L) Inpatient hospital services.
 - (M) Medical supplies, equipment, appliances, orthotics and prosthetics.
 - (N) EPSDT services furnished in a qualified child health center.
- (14) Family planning services and supplies for members of child-bearing age, including counseling, insertion of intrauterine device, implantation of subdermal contraceptive device, and sterilization for members twenty-one (21) years of age and older who are legally competent, not institutionalized and have signed the "Consent Form" at least thirty (30) days prior to procedure. Reversal of sterilization procedures for the purposes of conception is not covered. Reversal of sterilization procedures are covered when medically indicated and substantiating documentation is attached to the claim.
- (15) Physicians' services whether furnished in the office, the member's home, a hospital, a long-term care facility, intermediate care facilities for individuals with intellectual disabilities (ICF/IID), or elsewhere. For adults, payment is made for compensable hospital days described at OAC 317:30-5-41. Office visits for adults are limited to four (4) per month except when in connection with conditions as specified in OAC 317:30-5-9(b).
- (16) Medical care and any other type of remedial care recognized under state law, furnished by licensed practitioners within the scope of their practice as defined by state law. See applicable provider section for limitations to covered services for:
- (A) Podiatrists' services;
 - (B) Optometrists' services;
 - (C) Psychologists' services;
 - (D) Certified registered nurse anesthetists;
 - (E) Certified nurse midwives;
 - (F) Advanced practice registered nurses; and
 - (G) Anesthesiologist assistants.
- (17) Freestanding ambulatory surgery centers.
- (18) Prescribed drugs not to exceed a total of six (6) prescriptions with a limit of two (2) brand name prescriptions per month. Exceptions to the six (6) prescription limit are:

- (A) Unlimited medically necessary monthly prescriptions for:
 - (i) Members under the age of twenty-one (21) years; and
 - (ii) Residents of long-term care facilities or ICF/IID.
- (B) Seven (7) medically necessary generic prescriptions per month in addition to the six (6) covered under the State Plan (including three (3) brand name prescriptions) are allowed for adults receiving services under the 1915(c) home and community-based services (HCBS) waivers. These additional medically necessary prescriptions beyond the three (3) brand name or thirteen (13) total prescriptions are covered with prior authorization.
- (19) Rental and/or purchase of medical supplies, equipment, and appliances.
- (20) Adaptive equipment, when prior authorized, for members residing in private ICF/IID's.
- (21) Dental services for members residing in private ICF/IID's in accordance with the scope of dental services for members under age twenty-one (21).
- (22) For non-expansion adults, prosthetic devices are limited to catheters and catheter accessories, colostomy and urostomy bags and accessories, tracheostomy accessories, nerve stimulators, hyperalimentation and accessories, home dialysis equipment and supplies, external breast prostheses and support accessories, oxygen/oxygen concentrator equipment and supplies, respirator or ventilator equipment and supplies, and those devices inserted during the course of a surgical procedure. There is no coverage for orthotic devices for adults.
- (23) Orthotics and prosthetics, including prosthetic hearing implants and ocular prosthetics, are covered for expansion adult members, above the limitations within (22) of this Section, when prescribed by the treating provider (physician, physician assistant, or an advanced practice registered nurse) and medical necessity is documented in accordance with OAC 317:30-5-211.13.
- (24) Standard medical supplies.
- (25) Eyeglasses under EPSDT for members under age twenty-one (21). Payment is also made for glasses for children with congenital aphakia or following cataract removal. Payment is limited to two (2) glasses per year. Any glasses beyond this limit must be prior authorized and determined to be medically necessary.
- (26) Blood and blood fractions for members when administered on an outpatient basis.
- (27) Inpatient services for members age sixty-five (65) or older in institutions for mental diseases, limited to those members whose Medicare, Part A benefits are exhausted for this particular service and/or those members who are not eligible for Medicare services.
- (28) Long-term care facility services, limited to members preauthorized and approved by OHCA for such care.
- (29) Inpatient psychiatric facility admissions for members are limited to an approved length of stay with provision for requests for extensions.
- (30) Transportation and subsistence (room and board) to and from providers of medical services to meet member's needs (ambulance or bus, etc.), to obtain medical treatment.
- (31) Extended services for pregnant women including all pregnancy-related and postpartum services to continue to be provided, as though the women were pregnant, for twelve (12) months after the pregnancy ends regardless of the reason, beginning on the last date of pregnancy.
- (32) Long-term care facility services for members under twenty-one (21) years of age.
- (33) Personal care in a member's home, prescribed in accordance with a plan of treatment and rendered by a qualified person under supervision of a registered nurse (RN).

- (34) Medicare Part A, Part B, and Part C deductibles, coinsurance, and copays.
- (35) HCBS for the intellectually disabled.
- (36) Home health services can be provided without a PA for the first thirty-six (36) visits. A PA will be required beyond the 36th visit. The visits are limited to any combination of RN and nurse aide visits.
- (37) Medically necessary solid organ and bone marrow/stem cell transplantation services for children and adults are covered services based upon the conditions listed in (A)-(D) of this paragraph:
- (A) All transplantation services, except kidney and cornea, must be prior authorized;
 - (B) All transplant procedures are reviewed and prior authorization is based upon appropriate medical criteria;
 - (C) All organ transplants must be performed at a Medicare approved transplantation center;
 - (D) Procedures considered experimental or investigational are not covered. For more information regarding experimental or investigational including clinical trials, see OAC 317:30-3-57.1; and
 - (E) Donor search and procurement services are covered for transplants consistent with the methods used by the Medicare program for organ acquisition costs.
- (38) HCBS for intellectually disabled members who were determined to be inappropriately placed in a long-term care facility (Alternative Disposition Plan - ADP).
- (39) Case management services for the chronically and/or seriously mentally ill.
- (40) Emergency medical services, including emergency labor and delivery for undocumented or ineligible aliens.
- (41) Services delivered in Federally Qualified Health Centers (FQHCs). Payment is made on an encounter basis.
- (42) Early intervention services for children ages zero (0) to three (3).
- (43) Residential behavior management in therapeutic foster care setting.
- (44) Case management services through the Oklahoma Department of Mental Health and Substance Abuse Services (ODMHSAS).
- (45) HCBS for aged or physically disabled members.
- (46) Outpatient ambulatory services for members infected with tuberculosis.
- (47) Smoking and tobacco use cessation counseling for children and adults.
- (48) Services delivered to American Indians/Alaskan Natives (AI/AN) in Indian Health Services, Tribal Programs, and Urban Indian Clinics (I/T/Us). Payment is made on an encounter basis.
- (49) OHCA contracts with designated agents to provide disease state management for individuals diagnosed with certain chronic conditions. Disease state management treatments are based on protocols developed using evidence-based guidelines.
- (50) Residential substance use disorder (SUD) services.
- (51) Medication-assisted treatment (MAT) services.
- (52) Diabetes self-management education and support (DSMES).

SUBCHAPTER 5. INDIVIDUAL PROVIDERS AND SPECIALTIES

PART 17. MEDICAL SUPPLIERS

317:30-5-211.13. Orthotics and prosthetics

(a) Coverage of prosthetics for non-expansion adults is limited to (1) home dialysis equipment and supplies, (2) nerve stimulators, (3) external breast prosthesis and support accessories, and (4) implantable devices inserted during the course of a surgical procedure. Prosthetics prescribed by an appropriate qualified provider and as specified in this section are covered items for non-expansion adults. There is no coverage of orthotics for non-expansion adults.

(1) **Home dialysis.** Equipment and supplies are covered items for members receiving home dialysis treatments only.

(2) **Nerve stimulators.** Payment is made for transcutaneous nerve stimulators, implanted peripheral nerve stimulators, and neuromuscular stimulators.

(3) **Breast prosthesis, bras, and prosthetic garments.**

(A) Payment is limited to:

(i) One (1) prosthetic garment with mastectomy form every twelve (12) months for use in the postoperative period prior to a permanent breast prosthesis or as an alternative to a mastectomy bra and breast prosthesis;

(ii) Two (2) mastectomy bras per year; and

(iii) One (1) silicone or equal breast prosthetic per side every twenty-four (24) months; or

(iv) One (1) foam prosthetic per side every six (6) months.

(B) Payment will not be made for both a silicone and a foam prosthetic in the same twelve (12) month period.

(C) Breast prostheses, bras, and prosthetic garments must be purchased from a Board Certified Mastectomy Fitter.

(D) A breast prosthesis can be replaced if:

(i) Lost;

(ii) Irreparable damaged (other than ordinary wear and tear); or

(iii) The member's medical condition necessitates a different type of item and the physician provides a new prescription explaining the need for a different type of prosthesis.

(E) External breast prostheses are not covered after breast reconstruction is performed except in instances where a woman with breast cancer receives reconstructive surgery following a mastectomy, but the breast implant fails or ruptures and circumstances are such that an implant replacement is not recommended by the surgeon and/or desired by the member.

(4) **Prosthetic devices inserted during surgery.** Separate payment is made for prosthetic devices inserted during the course of surgery when the prosthetic devices are not integral to the procedure and are not included in the reimbursement for the procedure itself.

(b) Orthotics and prosthetics are covered for expansion adults services when:

(1) Orthotics are medically necessary when required to correct or prevent skeletal deformities, to support or align movable body parts, or to preserve or improve physical function.

(2) Prosthetics, including prosthetic hearing implants and ocular prosthetics, are medically necessary as a replacement for all or part of the function of a permanently inoperative, absent, or malfunctioning body part. The member shall require the prosthesis for mobility, daily care, or rehabilitation purposes.

(3) In addition, orthotics and prosthetics must be:

(A) A reasonable and medically necessary part of the member's treatment plan;

(B) Consistent with the member's diagnosis and medical condition, particularly the functional limitations and symptoms exhibited by the member; and

(C) Of high quality, with replacement parts available and obtainable.

(c) Refer to Oklahoma Administrative Code (OAC) 317:30-5-211.1 for definitions of orthotics and prosthetics.

DRAFT

**TITLE 317. OKLAHOMA HEALTH CARE AUTHORITY
CHAPTER 30. MEDICAL PROVIDERS-FEE FOR SERVICE**

SUBCHAPTER 5. INDIVIDUAL PROVIDERS AND SPECIALTIES

PART 3. HOSPITALS

317:30-5-41. Inpatient hospital coverage/limitations

(a) Covered hospital inpatient services are those medically necessary services which require an inpatient stay ordinarily furnished by a hospital for the care and treatment of inpatients and which are provided under the direction of a physician or dentist in an institution approved under OAC: 317:30:5-40.1(a) or (b) Claims for inpatient admissions in acute care or critical access hospitals are reimbursed the lesser of the billed charges or the Diagnosis Related Groups (DRG) amount.

(b) **Inpatient status.** OHCA considers a member an inpatient when ~~the member is admitted to the hospital and~~ a physician writes an order for the member to be admitted to a participating hospital; the member is admitted and is receiving room, board, and professional services provided on a continuous twenty-four (24) hour a day basis; and a member is counted in the midnight census. A length of stay less than twenty-four (24) hours may be considered if the stay meets an inpatient acuity level of care. In situations when a ~~member~~member's inpatient admission occurs and the member dies, is discharged following an obstetrical stay, or is transferred to another facility on the day of admission, the member is also considered an inpatient of the hospital.

(1) **Same day admission.** If a member is admitted and dies before the midnight census on the same day of admission, the member is considered an inpatient.

(2) **Same day admission/discharge - obstetrical and newborn stays.** A hospital stay is considered inpatient stay when a member is admitted and delivers a baby, even when the mother and baby are discharged on the date of admission (i.e., they are not included in the midnight census). This rule applies when the mother and/or newborn are transferred to another hospital.

(3) **Same day admission/discharges other than obstetrical and newborn stays.** In the event a member is admitted as an inpatient, but is determined to not qualify for an inpatient payment based on OHCA ~~criteria,~~review, the hospital may bill on an outpatient claim for the ancillary services provided during that time.

(4) **Discharges and Transfers.** A hospital inpatient is considered discharged from a hospital paid under the DRG-based payment system when:

(A) The patient is formally released from the hospital; or

(B) The patient dies in the hospital; or

(C) The patient is transferred to a hospital that is excluded from the DRG-based payment system, or transferred to a distinct part psychiatric or rehabilitation unit of the same hospital. Such instances will result in two or more claims. Effective January 1, 2007, distinct part psychiatric and rehabilitation units excluded from the Medicare Prospective Payment System (PPS) of general medical surgical hospitals will require a separate provider identification number.

317:30-5-47. Reimbursement for inpatient hospital services

Reimbursement will be made for inpatient hospital services in the following manner:

(1) Covered inpatient services provided to eligible SoonerCare members admitted to in-state

acute care and critical access hospitals will be reimbursed the lesser of the billed charges or the Diagnosis Related Group (DRG) amount. In addition to the billed charges or DRG payment, whichever is less, an outlier payment may be made to the hospital for very high-cost stays. Additional outlier payment is applicable if either the amount billed by the hospital or DRG payment, whichever applies, is less than a threshold amount of the hospital cost. Each inpatient hospital claim is tested to determine whether the claim qualified for a cost outlier payment. Payment is equal to a percentage of the cost after the threshold is met.

(2) The lesser of the billed charges or DRG amount and outlier, if applicable, represent full reimbursement for all non-physician services provided during the inpatient stay. Payment includes but is not limited to:

(A) Laboratory services;

(B) Prosthetic devices, including pacemakers, lenses, artificial joints, cochlear implants, implantable pumps;

(C) Technical component on radiology services;

(D) Transportation, including ambulance, to and from another facility to receive specialized diagnostic and therapeutic services;

(E) Pre-admission diagnostic testing performed within seventy-two (72) hours of admission; and

(F) Organ transplants.

(3) Charges for services or supplies deemed not medically necessary and/or not separately billable may be recouped upon post payment review of outlier payments.

~~(3)~~(4) Hospitals may submit a claim for payment only upon the final discharge of the patient or upon completion of a transfer of the patient to another hospital.

~~(4)~~(5) Covered inpatient services provided to eligible members of the SoonerCare program, when treated in out-of-state hospitals will be reimbursed in the same manner as in-state hospitals. Refer to OAC 317:30-3-90 and 317:30-3-91.

~~(5)~~(6) Cases which indicate transfer from one (1) acute care hospital to another will be monitored under a retrospective utilization review policy to help ensure that payment is not made for inappropriate transfers.

~~(6)~~(7) The transferring hospital will be paid the lesser of the calculated transfer fee or the DRG base payment amount for a non-transfer.

~~(7)~~(8) If the transferring or discharge hospital or unit is exempt from the DRG, that hospital or unit will be reimbursed according to the method of payment applicable to the particular facility or units.

~~(8)~~(9) Covered inpatient services provided in out-of-state specialty hospitals may be reimbursed at a negotiated rate not to exceed one-hundred percent (100%) of the cost to provide the service. Negotiation of rates will only be allowed when the OHCA determines that the specialty hospital or specialty unit provides a unique (non-experimental) service required by SoonerCare members and the provider will not accept the DRG payment rate. Prior authorization is required.

~~(9)~~(10) New providers entering the SoonerCare program will be assigned a peer group and will be reimbursed at the peer group base rate for the DRG payment methodology or the statewide median rate for per diem methods.

~~(10)~~(11) All inpatient services are reimbursed per the methodology described in this Section and/or as approved under the Oklahoma Medicaid State Plan.

~~(11)~~(12) For high-investment drugs, refer to OAC 317:30-5-47.6.

**TITLE 317. OKLAHOMA HEALTH CARE AUTHORITY
CHAPTER 30. MEDICAL PROVIDERS-FEE FOR SERVICE**

SUBCHAPTER 5. INDIVIDUAL PROVIDERS AND SPECIALTIES

PART 21. OUTPATIENT BEHAVIORAL HEALTH SERVICES

317:30-5-240.3. Staff credentials

(a) **Licensed behavioral health professional (LBHPs).** LBHPs are defined as any of the following practitioners:

(1) An allopathic or osteopathic physician with a current license and board certification in psychiatry or board eligible in the state in which services are provided, or a current resident in psychiatry practicing as described in OAC 317:30-5-2.

(2) A practitioner with a current license to practice in the state in which services are provided, within one (1) of the areas of practice listed in (A) through (F). The exemptions from licensure under 59 O.S. § 1353(4) and (5), 59 O.S. § 1903(C) and (D), 59 O.S. § 1925.3(B) and (C), and 59 O.S. § 1932(C) and (D) do not apply to outpatient behavioral health services.

(A) Psychology;

(B) Social work (clinical specialty only);

(C) Professional counselor;

(D) Marriage and family therapist;

(E) Behavioral practitioner; or

(F) Alcohol and drug counselor.

(3) An advanced practice registered nurse (APRN) certified in a psychiatric mental health specialty, and licensed as a registered nurse (RN) with a current certification of recognition from the board of nursing in the state in which services are provided.

(4) A physician assistant who is licensed and in good standing in the state in which services are provided and has received specific training for and is experienced in performing mental health therapeutic, diagnostic, or counseling functions.

(b) **Licensure candidates.** Licensure candidates are practitioners actively and regularly receiving board-approved supervision, and extended supervision by a fully licensed clinician if board's supervision requirement is met but the individual is not yet licensed, to become licensed by one (1) of the areas of practice listed in (2)(A) through (F) above. The supervising LBHP responsible for the member's care must:

(1) Staff the member's case with the candidate;

(2) Be personally available, or ensure the availability of an LBHP to the licensure candidate for consultation while they are providing services;

(3) Agree with the current plan for the member;

(4) Confirm that the service provided by the candidate was appropriate; and

(5) The member's medical record must show that the requirements for reimbursement were met and the LBHP responsible for the member's care has reviewed, countersigned, and dated the service plan and any updates thereto so that it is documented that the licensed professional is responsible for the member's care.

(c) **Certified alcohol and drug counselors (CADCs).** CADCs are defined as having a current certification as a CADC in the state in which services are provided.

(d) **Multi systemic therapy (MST) provider.** Master's level therapist who works on a team established by the Oklahoma Juvenile Affairs Office (OJA) which may include bachelor's level staff.

(e) **Peer recovery support specialist (PRSS)/Family peer recovery support specialist (F-PRSS).** The PRSS and F-PRSS must be certified by ODMHSAS pursuant to requirements found in OAC 450:53.

(f) **Family support and training provider (FSP).** FSPs must:

- ~~(1) Have a high school diploma or equivalent;~~
- ~~(2) Be twenty-one (21) years of age and have a successful experience as a family member of a child/adolescent with serious emotional disturbance, or a minimum of have lived experience as the primary caregiver of a child/adolescent who has received services for substance use disorder and/or co-occurring substance use and mental health, or have lived experience being the caregiver for a child/adolescent with Child Welfare/Child Protective Services involvement;~~
- ~~(3) Successfully complete family support training according to a curriculum approved by ODMHSAS and pass the examination with a score of eighty percent (80%) or better;~~
- ~~(4) Pass Oklahoma State Bureau of Investigation (OSBI) background check;~~
- ~~(5) Have treatment plans be overseen and approved by a licensed behavioral health professional (LBHP) or licensure candidate; and~~
- ~~(6) Function under the general direction of an LBHP, licensure candidate or systems of care team, with an LBHP or licensure candidate available at all times to provide back up, support, and/or consultation.~~

~~(g)~~(f) **Qualified behavioral health aide (QBHA).** QBHAs must:

- ~~(1) Have completed sixty (60) hours or equivalent of college credit; or may substitute one (1) year of relevant employment and/or responsibility in the care of children with complex emotional needs for up to two (2) years of college experience~~Possess current certification as a Behavioral Health Case Manager I; and
- ~~(2) Have successfully completed the specialized training and education curriculum provided by the ODMHSAS; and~~
- ~~(3) Be supervised by a bachelor's level individual with a minimum of two (2) years case management or care coordination experience; and~~
- ~~(4) Have service plans be overseen and approved by an LBHP or licensure candidate; and~~
- ~~(5) Function under the general direction of an LBHP, or licensure candidate and/or systems of care team, with an LBHP or licensure candidate available at all times to provide back up, support, and/or consultation.~~

(h) **Behavioral health case manager.** For behavioral health case management services to be compensable by SoonerCare, the provider performing the services must be an LBHP, licensure candidate, CADC or have and maintain a current certification as a ~~case manager~~Behavioral Health Case Manager II (CM II) or case manager Behavioral Health Case Manager I (CM I) from ODMHSAS in accordance with requirements found in OAC 450:50. ~~The requirements for obtaining these certifications are as follows:~~

~~(1) The CM II must meet the requirements in (A), (B), (C) or (D) below:~~

- ~~(A) Possess a bachelor's or master's degree in a behavioral health related field earned from a regionally accredited college or university recognized by the United States Department of Education (USDE) or a bachelor's or master's degree in education; and complete web-based training for behavioral health case~~

~~management and behavioral health rehabilitation as specified by ODMHSAS; and complete one (1) day of face to face behavioral health case management training and two (2) days of face to face behavioral health rehabilitation training as specified by ODMHSAS; and pass web based competency exams in behavioral health case management and behavioral health rehabilitation.~~

~~(B) Be licensed and in good standing as a registered nurse in the state in which services are provided, with experience in behavioral health care; complete web-based training for behavioral health case management and behavioral health rehabilitation as specified by ODMHSAS; complete one (1) day of face to face behavioral health case management training and two (2) days of face to face behavioral health rehabilitation training as specified by ODMHSAS; and pass web-based competency exams for behavioral health case management and behavioral health rehabilitation.~~

~~(C) Possess a bachelor's or master's degree in any field earned from a regionally accredited college or university recognized by the USDE and a current certification or Children's Certificate in Psychiatric Rehabilitation from the US Psychiatric Rehabilitation Association (USPRA); complete the behavioral health case management web based training as specified by ODMHSAS; complete one (1) day of face to face behavioral health case management training; and pass web-based competency exams for behavioral health case management. Applicants who have not received a certificate in children's psychiatric rehabilitation from the USPRA must also complete the behavioral health rehabilitation web based training as specified by ODMHSAS.~~

~~(D) Possess a bachelor's or master's degree in any field and proof of active progression toward obtaining a clinical licensure master's or doctoral degree at a regionally accredited college or university recognized by the USDE and complete web based training for behavioral health case management and behavioral health rehabilitation as specified by ODMHSAS; complete one (1) day of face to face behavioral health case management training and two (2) days of face to face behavioral health rehabilitation training as specified by ODMHSAS; and pass web-based competency exams in behavioral health case management and behavioral health rehabilitation.~~

~~(2) The CM I meets the requirements in either (A) or (B) and (C):~~

~~(A) Completed sixty (60) college credit hours; or~~

~~(B) Possesses a high school diploma with thirty-six (36) total months of experience working with persons who have a mental illness and/or substance abuse. Documentation of experience on file with ODMHSAS; and~~

~~(C) Completes two (2) days of ODMHSAS specified behavioral health case management training and passes a web-based competency exam for behavioral health case management.~~

~~(3)(1) A Wraparound facilitator case manager isFacilitator Case Manager must be an LBHP, licensure candidate or CADC that meets the qualifications for CM II and has the following:~~

~~(A) Successful completion of the ODMHSAS training for wraparound facilitation within six (6) months of employment; and~~

(B) Participate in ongoing coaching provided by ODMHSAS and employing agency; ~~and~~

(C) Successfully complete wraparound credentialing process within nine (9) months of beginning process; and

(D) Direct supervision or immediate access and a minimum of one (1) hour weekly clinical consultation with a qualified mental health professional, as required by ODMHSAS.

~~(4)(2) An Intensive case manager is~~ Case Manager must be an LBHP, licensure candidate, or CADC that meets the provider qualifications of a CM II and has the following:

(A) A minimum of two (2) years behavioral health case management experience; ~~crisis diversion experience;~~ and

~~(B) Must have attended the ODMHSAS six (6) hours intensive case management training.~~

(B) Crisis diversion experience.

317:30-5-241.5 Support services

(a) Program of Assertive Community Treatment (PACT) Services.

(1) **Definition.** PACT is provided by an interdisciplinary team that ensures service availability 24 hours a day, seven days a week and is prepared to carry out a full range of treatment functions wherever and whenever needed. An individual is referred to the PACT team service when it has been determined that his/her needs are so pervasive and/or unpredictable that it is unlikely that they can be met effectively by other combinations of available community services, or in circumstances where other levels of outpatient care have not been successful to sustain stability in the community.

(2) **Target population.** Individuals 18 years of age or older with serious and persistent mental illness and co-occurring disorders. PACT services are those services delivered within an assertive community-based approach to provide treatment, rehabilitation, and essential behavioral health supports on a continuous basis to individuals 18 years of age or older with serious mental illness with a self-contained multi-disciplinary team. The team must use an integrated service approach to merge essential clinical and rehabilitative functions and staff expertise. This level of service is to be provided only for persons most clearly in need of intensive ongoing services.

(3) **Qualified practitioners.** Providers of PACT services are specific teams within an established organization and must be operated by or contracted with and certified by the ODMHSAS in accordance with 43A O.S. 319 and OAC 450:55. The team leader must be an LBHP or Licensure Candidate.

(4) **Limitations.** PACT services are billable in 15 minute units. A maximum of 105 hours per member per year in the aggregate is allowed. All PACT compensable SoonerCare services are required to be face-to-face. The following services are separately billable: Case management, facility-based crisis stabilization, physician and medical services.

(5) **Service requirements.** PACT services must include the following:

(A) PACT assessments (initial and comprehensive);

(i) **Initial assessment.** is the initial evaluation of the member based upon available information, including self-reports, reports of family members and other significant parties, and written summaries from other agencies, including police, court, and

outpatient and inpatient facilities, where applicable, culminating in a comprehensive initial assessment. Member assessment information for admitted members shall be completed on the day of admission to the PACT. The start and stop times for this service should be recorded in the chart.

(ii) **Comprehensive assessment.** is the organized process of gathering and analyzing current and past information with each member and the family and/or support system and other significant people to evaluate: 1) mental and functional status; 2) effectiveness of past treatment; 3) current treatment, rehabilitation and support needs to achieve individual goals and support recovery; and 4) the range of individual strengths (e.g., knowledge gained from dealing with adversity or personal/professional roles, talents, personal traits) that can act as resources to the member and his/her recovery planning team in pursuing goals. Providers must bill only the face-to-face service time with the member. Non-face to face time is not compensable. The start and stop times for this service should be recorded in the chart.

(B) Behavioral health service plan (moderate and low complexity by a non-physician treatment planning and review) is a process by which the information obtained in the comprehensive assessment, course of treatment, the member, and/or treatment team meetings is evaluated and used to develop a service plan that has individualized goals, objectives, activities and services that will enable a member to improve. The initial assessment serves as a guide until the comprehensive assessment is completed. It is to focus on recovery and must include a discharge plan. It is performed with the direct active participation by the member. SoonerCare compensation for this service includes only the face to face time with the member. The start and stop times for this service should be recorded in the chart.

(C) Treatment team meetings (team conferences with the member present) is a billable service. This service is conducted by the treatment team, which includes the member and all involved practitioners. For a complete description of this service, see OAC 450:55-5-6 Treatment Team Meetings. This service can be billed to SoonerCare only when the member is present and participating in the treatment team meeting. The conference starts at the beginning of the review of an individual member and ends at the conclusion of the review. Time related to record keeping and report generation is not reported. The start and stop times should be recorded in the member's chart. The participating psychiatrist/physician should bill the appropriate CPT code; and the agency is allowed to bill one treatment team meeting per member as medically necessary.

(D) Individual and family psychotherapy;

(E) Individual rehabilitation;

(F) Recovery support services;

(G) Group rehabilitation;

(H) Group psychotherapy;

(I) Crisis Intervention;

(J) Medication training and support services;

(K) Blood draws and /or other lab sample collection services performed by the nurse.

(b) Therapeutic Behavioral Services.

(1) **Definition.** Therapeutic behavioral services include behavior management and redirection and behavioral and life skills remedial training provided by qualified behavioral health aides. The behavioral health aide also provides monitoring and observation of the child's

emotional/behavioral status and responses, providing interventions, support and social skills redirection when needed. Training is generally focused on behavioral, interpersonal, communication, ~~self-help~~self-help, safety and daily living skills.

(2) **Target population.** This service is limited to children with serious emotional disturbance who are in an ODMHSAS contracted systems of care ~~community-based~~community-based treatment program, or are under OKDHS or OJA custody residing within a RBMS level of care, who need intervention and support in their living environment to achieve or maintain stable successful treatment outcomes.

(3) **Qualified practitioners.** Qualified Behavioral Health Aides (QBHA) must possess certification as a Behavioral Health Case Manager I and be trained/credentialed through ODMHSAS.

(4) **Limitations.** The ~~Behavioral Health Aide~~QBHA cannot bill for more than one individual during the same time period. Therapeutic behavioral services by a BHA, Treatment Parent Specialist (TPS) or Behavioral Health School Aide (BHSA) cannot be delivered during the same clock time.

(5) **Documentation requirements.** Providers must follow requirements listed in OAC 317:30-5-248.

(e) Family Support and Training.

(1) **Definition.** ~~This service provides the training and support necessary to ensure engagement and active participation of the family in the service plan development process and with the ongoing implementation and reinforcement of skills learned throughout the treatment process. Child Training is provided to family members to increase their ability to provide a safe and supportive environment in the home and community for the child. Parent Support ensures the engagement and active participation of the family in the service plan development process and guides families toward taking a proactive role in their child's treatment. Parent Training is assisting the family with the acquisition of the skills and knowledge necessary to facilitate an awareness of their child's needs and the development and enhancement of the family's specific problem solving skills, coping mechanisms, and strategies for the child's symptom/behavior management.~~

(2) **Target population.** ~~Family Support and Training is designed to benefit the SoonerCare eligible child experiencing a serious emotional disturbance who is in an ODMHSAS contracted systems of care community based treatment program, are diagnosed with a pervasive developmental disorder, or are under OKDHS or OJA custody, are residing within a RBMS level of care or are at risk for out of home placement, and who without these services would require psychiatric hospitalization.~~

(3) **Qualified practitioners.** ~~Family Support Providers (FSPs) must be trained/credentialed through ODMHSAS.~~

(4) **Limitations.** ~~The FSP cannot bill for more than one individual during the same time period.~~

(5) **Documentation requirements.** ~~Providers must comply with requirements listed in OAC 317:30-5-248.~~

(d)(c) Peer Recovery Support Services (PRSS).

(1) **Definition.** Peer recovery support services are an EBP model of care which consists of a qualified ~~peer recovery support specialist provider~~Peer Recovery Support Specialist (PRSS) who assists individuals with their recovery from behavioral health disorders. Recovery Support is a service delivery role in the ODMHSAS public and contracted provider system

~~throughout the behavioral health care system~~ where the provider understands what creates recovery and how to support environments conducive of recovery. The role is not interchangeable with traditional staff members who usually work from the perspective of their training and/or their status as a licensed behavioral health provider; rather, this provider works from the perspective of their experimental expertise and specialized ~~credential~~-training. They lend unique insight into mental illness and what makes recovery possible because they are in recovery. Family Peer Recovery Support Specialists (F-PRSS) focus on the family unit of a child or adolescent, ensuring the engagement and active participation of the family during treatment and guiding families toward taking a proactive role in their family member's recovery, for the benefit of the SoonerCare eligible child or adolescent. Services may include assisting the family with the acquisition of the skills and knowledge necessary to facilitate an awareness of their child's needs and the development and enhancement of the family's problem-solving skills, coping mechanisms, and strategies for the child's symptom/behavior management.

(2) **Target population.** ~~Children 16~~Members age sixteen (16) years of age and over with SED and/or substance use disorders, ~~and~~ adults 18 and over with SMI and/or substance use disorder(s), and family units with a child or adolescent experiencing an SED and/or substance use disorder.

(3) **Qualified professionals.** Peer Recovery Support Specialists (PRSS) and Family Peer Recovery Support Specialists (F-PRSS) must be certified through ODMHSAS pursuant to OAC 450:53. A PRSS may provide services to individuals sixteen (16) years of age or older. An F-PRSS may provide services to families with children and adolescents.

(4) **Limitations.** The PRSS and F-PRSS cannot bill for more than one individual service during the same time period. This service can be an individual or group service. Groups have no restriction on size.

(5) **Documentation requirements.** Providers must comply with requirements listed in OAC 317:30-5-248.

(6) **Service requirements.**

(A) PRSS staff utilizing their knowledge, skills and abilities will:

- (i) teach and mentor the value of every individual's recovery experience;
- (ii) model effective coping techniques and self-help strategies;
- (iii) assist members or their family members in articulating personal goals for recovery; and
- (iv) assist members or their family members in determining the objectives needed to reach his/her recovery goals.

(B) PRSS staff utilizing ongoing training must:

- (i) proactively engage members ~~and~~ possessor their family members using communication skills/ability to transfer new concepts, ideas, and insight to others;
- (ii) facilitate peer support groups;
- (iii) assist in setting up and sustaining self-help (mutual support) groups;
- (iv) support members in using a Wellness Recovery Action Plan (WRAP);
- (v) assist in creating a crisis plan/Psychiatric Advanced Directive;
- (vi) utilize and teach problem solving techniques with members or their family members;
- (vii) teach members how to identify and combat negative self-talk and fears;

- (viii) support the vocational choices of members and assist him/her in overcoming job-related anxiety;
- (ix) assist in building social skills in the community that will enhance quality of life. Support the development of natural support systems;
- (x) assist other staff in identifying program and service environments that are conducive to recovery and;
- (xi) attend treatment team and program development meetings to ensure the presence of the member's voice and to promote the use of self-directed recovery tools.

DRAFT

**TITLE 317. OKLAHOMA HEALTH CARE AUTHORITY
CHAPTER 30. MEDICAL PROVIDERS-FEE FOR SERVICE**

SUBCHAPTER 5. INDIVIDUAL PROVIDERS AND SPECIALTIES

PART 85. ADVANTAGE PROGRAM WAIVER SERVICES

317:30-5-761. Eligible providers

~~ADvantage Program~~The ADvantage Administration (AA) certifies ADvantage Program service providers, except pharmacy providers, ~~and they~~ Providers must have a current signed SoonerCare (Medicaid) contract on file with the Oklahoma Health Care Authority (OHCA), the State Medicaid agency.

(1) The provider ~~programmatic certification~~ certification process verifies the provider meets licensure, certification, and training standards, and uses sound business management practices and has a financially stable business, as specified in the waiver document. All providers, except nursing facility (NF) respite; medical equipment and supplies; and environmental modification providers, ~~must obtain programmatic certification~~ meet certification requirements to be ADvantage program certified.

(2) ~~The provider financial certification verifies the provider uses sound business management practices and has a financially stable business. All providers, except for NF respite; medical equipment and supplies; and environmental modification providers, will obtain financial certification to be ADvantage program certified~~ verify the provider meets licensure and certification standards as applicable.

(3) At minimum, provider financial certification is re-evaluated annually.

(4) Providers may fail to gain or may lose ADvantage program certification due to failure to meet programmatic or financial standards.

(5) All provider service types must agree to and sign the Conditions of Provider Participation and Service Standards.

(6) The Oklahoma Human Services (OKDHS) Community Living, Aging and Protective Services (CAP) does not authorize the member's ~~CD-PASS~~ CDPASS services provider to also have an active power of attorney for the member.

(7) OKDHS CAP may authorize a member's legally-responsible spouse or legal guardian to be SoonerCare (Medicaid) reimbursed, per 1915(c) ADvantage Program as a personal care; service provider. Authorization for a spouse or legal guardian as a provider requires the criteria in (A) through (D) of this paragraph and monitoring provisions to be met.

(A) Authorization for a spouse or legal guardian to be a member's care provider may occur only when the member is offered provider choice and documentation demonstrates:

(i) No provider included on the Certified Agency Report (CAR) or in the member's service area, has available staffing. Documentation also affirms all area providers attempt to employ staff to serve; or

(ii) The member's needs are so complex that unless the spouse or legal guardian provides the care, the member's risk level would increase; ~~and/or~~

(iii) It is mentally or physically detrimental for someone other than the spouse or legal guardian to provide care. This is evidenced by documentation from a qualified clinician or medical provider, such as a physician or licensed psychologist.

(B) The service:

- (i) Meets service or support definition as outlined in the federally-approved waiver document;
 - (ii) Is necessary to avoid institutionalization;
 - (iii) Is a service or support specified in the person-centered service plan;
 - (iv) Is provided by a person who meets the provider qualifications and training standards specified in the waiver for that service;
 - (v) Is paid at a rate that does not exceed what is paid to a provider of a similar service and does not exceed what OHCA allows for personal care or personal assistance services payment; and
 - (vi) Is not an activity the spouse or legal guardian would ordinarily perform or is responsible to perform.
- (C) The spouse or legal guardian service provider complies with:
- (i) Providing no more than forty (40) service hours of services in a seven (7) day period;
 - (ii) Planned work schedules that are available in advance for the member's case manager, and variations to the schedule are noted and supplied to the case manager two (2) weeks in advance unless the change is due to an emergency;
 - (iii) Maintaining and submitting time sheets and other required documentation for hours paid; ~~and~~
 - (iv) The person-centered service plan as the member's care provider; and
 - (v) Continuing non-reimbursed family responsibilities of primary caregiver and emergency backup caregiver.
- (D) In addition to case management, monitoring, and reporting activities required for all waiver services, ~~the State is obligated to additional monitoring requirements~~ when members elect to use a spouse or legal guardian as a paid service provider, the case manager must visit the member at least monthly to monitor the continued appropriateness ~~The AA monitors, through quarterly documentation the case manager submits, the continued appropriateness~~ of the policy exception that allows the spouse or legal guardian to serve as the member's paid caregiver, and document findings in the member's electronic record.
- (8) ~~Durable medical equipment and supplies providers comply with Oklahoma Administrative Code 317:30-5-210(2) regarding delivery proof for items shipped to the member's residence.~~
- (9) OKDHS CAP periodically performs a programmatic/provider audit of:
- (A) Adult day health;
 - (B) Assisted living;
 - (C) Case Management;
 - (D) Home care:
 - (i) Skilled nursing;
 - (ii) Personal care;
 - (iii) In-home respite; ~~and~~
 - (iv) Advanced supportive or restorative assistance; and
 - (v) Therapy services; and
 - (E) ~~CD-PASS~~CDPASS providers.
- (10)(9) When, due to a programmatic/provider audit, a provider plan of correction (POC) is required, the AA may stop new cases and referrals to the provider, by removing from the CAR, until the POC is approved, implemented, and a follow-up review occurs. Depending on the

nature and severity of problems discovered during a programmatic audit (and at OKDHS CAP discretion), members determined to be at risk for health or safety may be transferred from a provider requiring a POC to another provider.

DRAFT

This page intentionally left blank

**TITLE 317. OKLAHOMA HEALTH CARE AUTHORITY
CHAPTER 35. MEDICAL ASSISTANCE FOR ADULTS AND CHILDREN-
ELIGIBILITY**

SUBCHAPTER 15. STATE PLAN PERSONAL CARE SERVICES

317:35-15-2. State Plan Personal Care (SPPC) services

(a) SPPC services assist a member in carrying out Activities of Daily Living (ADLs) or Instrumental Activities of Daily Living (IADLs) directly related to the member's personal care needs. SPPC services prevent or minimize physical health regression or deterioration. SPPC services require a skilled nursing assessment to:

- (1) Assess a member's needs;
- (2) Develop a care plan to meet the member's identified personal care needs;
- (3) Manage care plan oversight; and
- (4) Periodically reassess and update the care plan when necessary.

(b) SPPC services do not include technical services, such as:

- (1) Suctioning;
- (2) Tracheal care;
- (3) Gastrostomy-tube feeding or care;
- (4) Specialized feeding due to choking risk;
- (5) Applying compression stockings;
- (6) Bladder catheterization;
- (7) Colostomy irrigation;
- (8) Wound care;
- (9) Applying prescription lotions or topical ointments;
- (10) Range of motion exercises; or
- (11) Operating equipment of technical nature, such as a patient lift or oxygen equipment.

(c) SPPC members may receive services in limited types of living arrangements as per (1) through (5) of this subsection.

(1) SPPC members are not eligible to receive services while residing in an institutional setting including, but not limited to:

(A) Licensed facilities, such as a:

- (i) Hospital;
- (ii) Nursing facility;
- (iii) Licensed residential care facility; or
- (iv) Licensed assisted living facility; or

(B) In an unlicensed institutional living arrangement, such as a room and board home or facility.

(2) SPPC is not approved when the member lives in the personal care assistant's (PCA) ~~or the individual personal care assistant's (IPCA)~~ home, except with Oklahoma Human Services (OKDHS) Medicaid Services Unit approval.

(3) Members may receive SPPC services in the member's own home, apartment, or a family member's or friend's home or apartment. A home or apartment unit is defined as a self-contained living space having a lockable entrance to the unit including a bathroom and food storage and preparation amenities in addition to bedroom and living space.

(4) For SPPC members who are full-time students, a dormitory room qualifies as an allowable

living arrangement to receive SPPC services.

(5) With prior OKDHS Health Care Management Nurse III approval, SPPC services may be provided in an ~~educational or~~ employment setting to assist the member to achieve vocational goals identified in the care plan.

~~(d) A member may employ an IPCA to provide SPPC services. An IPCA may provide SPPC services when he or she is employed by a home care agency, provided the home care agency is certified and contracted with the Oklahoma Health Care Authority (OHCA) to provide SPPC services. Before providing SPPC services, OKDHS determines whether the IPCA is qualified to provide personal care services and the IPCA is not identified as formal or informal support for member. Persons eligible to serve as either IPCAs or PCAs:~~

- ~~(1) Are at least eighteen (18) years of age;~~
- ~~(2) Have no pending notation related to abuse, neglect, or exploitation as reported by the Oklahoma State Department of Health Nurse Aide Registry;~~
- ~~(3) Are not included in the OKDHS Community Services Worker Registry;~~
- ~~(4) Are not convicted of a crime and do not have a criminal background history or registry listings that ~~prohibit~~ prohibits employment per Title 63 of the Oklahoma Statutes Section 1-1944 through ~~1-9481-1948~~;~~
- ~~(5) Demonstrate the ability to understand and carry out assigned tasks;~~
- ~~(6) Are not a legally responsible family member of the member being served, such as a spouse, legal guardian, or a minor child's parent;~~
- ~~(7) Have a verifiable work history or personal references, and verifiable identification; and~~
- ~~(8) Meet any additional requirements outlined in the contract and certification requirements with OHCA.~~

~~(e) SPPC services eligibility is contingent on a member requiring one (1) or more of the services offered at least monthly including personal care, meal preparation, housekeeping, laundry, shopping or errands, or specified special tasks to meet ADL or IADL assessed needs.~~

317:35-15-4. State Plan Personal Care (SPPC) services medical eligibility determination

(a) **Eligibility.** The Oklahoma Human Services (OKDHS) Health Care Management Nurse (HCMN) III determines medical eligibility for SPPC services based on the Uniform Comprehensive Assessment Tool (UCAT) and the determination that the member has unmet care needs that require personal care assistance. SPPC services are initiated to support the regular care provided in the member's home. SPPC services are not intended to take the place of regular care, general maintenance tasks, or meal preparation provided by natural supports, such as spouses or other adults who live in the same household. Additionally, SPPC services are not furnished when they principally benefit the family unit. To be eligible for SPPC services, the applicant:

- (1) Has adequate informal supports. This means there is adult supervision that is present or available to contribute to care, or decision-making ability, as documented on the UCAT. To remain in his or her home without risk to his or her health, safety, and well-being, the applicant:
 - (A) Has the decision-making ability to respond appropriately to situations that jeopardize his or her health and safety, or has available supports that compensate for his or her lack of ability as documented on the UCAT; or
 - (B) Has his or her decision-making ability, lacks the physical capacity to respond appropriately to situations that jeopardize health and safety, and an OKDHS HCMN I or II informed him or her of potential risks and consequences of remaining in the home.
- (2) Requires a care plan for planning and administering services delivered under a professional

personnel's supervision;

(3) Has a physical impairment or combination of physical and mental impairments as documented on the UCAT. An applicant who poses a threat to himself or herself or others, as supported by professional or credible documentation, may not be approved for SPPC services. An individual who is actively psychotic or believed to be in danger of potential harm to himself or herself or others may not be approved;

(4) Does not have household members or persons who routinely visit the household who, as supported by professional or credible documentation, pose a threat of harm or injury to the applicant or other household visitors;

(5) Lacks the ability to meet personal care needs without additional supervision or assistance, or to communicate needs to others; and

(6) Requires assistance, not of a technical nature, to prevent or minimize physical health regression and deterioration.

(b) **Definitions.** The following words and terms, when used in this subsection, shall have the following meaning, unless the context clearly indicates otherwise:

(1) "**Activities of Daily Living (ADL)**" means activities that reflect the applicant's or member's ability to perform self-care tasks essential for sustaining health and safety, such as:

(A) Bathing;

(B) Eating;

(C) Dressing;

(D) Grooming;

(E) Transferring, including activities such as getting in and out of a tub or moving from bed to chair;

(F) Mobility;

(G) Toileting; and

(H) Bowel or bladder control.

(2) "**ADLs score of three (3) or greater**" means the applicant or member cannot do at least one (1) ADL at all or needs some help with two (2) or more ADLs.

(3) "**Applicant or Member support very low**" means the applicant's or member's UCAT Support score is zero (0), this indicates, in the UCAT assessor's clinical judgment, the formal and informal sources are sufficient for the applicant's or member's present need level in most functional areas.

(4) "**Applicant or Member support low**" means the member's UCAT Support score is five (5), this indicates, in the UCAT assessor's clinical judgment, the support from formal and informal sources are nearly sufficient for the applicant's or member's present need level in most functional areas. The applicant or member, family, or informal supports are meeting most needs typically expected of family or household members to share or do for one another, such as general household maintenance. There is little risk of institutional placement with loss of current supports.

(5) "**Applicant or Member support moderate**" means the UCAT applicant or member score is fifteen (15), this indicates, in the UCAT assessor's clinical judgment, the formal and informal support is available, but overall, it is inadequate, changing, fragile, or otherwise problematic. The applicant or member requires additional assistance that usually includes personal care assistance with one (1) or more ADLs not available through Medicare, the Veterans Administration, or other federal entitlement programs. Informal caregiver support is considered questionable or unreliable due to one (1) or more criteria in (A) through (D) of this paragraph:

- (A) Care or support is required continuously with no relief or backup available;
- (B) Informal support lacks continuity due to conflicting responsibilities such as work or child care;
- (C) Persons with advanced age or disability provide care; or
- (D) Institutional placement can reasonably be expected with any loss of existing support.

(6) "**Applicant or Member support high**" means the applicant or member score is twenty-five (25) this indicates, in the UCAT assessor's clinical judgment, the formal and informal supports are not sufficient as there is very little or no support available to meet the applicant's or member's high degree of need.

(7) "**Community Services Worker**" means any non-licensed health professional employed by or under contract with a community services provider who provides, for compensation or as a volunteer, health-related services, training, or supportive assistance to frail elderly, disabled person(s), or person(s) with developmental disabilities.

(8) "**Community Services Worker Registry**" means an OKDHS established registry established by the OKDHS per Section ~~(4)~~(§) ~~1025.1~~1025.3 of Title 56 of the Oklahoma Statutes (O.S.) listing community services workers who have a final investigative finding of abuse, neglect, or exploitation, per 43A O.S. §10-103, involving a frail elderly person, or person(s) with developmental or other disabilities was made by OKDHS or an administrative law judge.

(9) "**Instrumental Activities of Daily Living (IADL)**" means those daily activities that reflect the applicant or member's ability to perform household chores and tasks within the community essential for sustaining health and safety, such as:

- (A) Shopping;
- (B) Cooking;
- (C) Cleaning;
- (D) Managing money;
- (E) Using a phone;
- (F) Doing laundry;
- (G) Taking medication; and
- (H) Accessing transportation.

(10) "**IADLs score is at least six (6)**" means the applicant or member needs some help with at least three (3) IADLs or cannot do two (2) IADLs at all.

(11) "**IADLs score of eight (8) or greater**" means the applicant or member needs some help with at least four (4) IADLs or the member cannot do two (2) IADLs at all and needs some help with one (1) or more other IADLs.

(12) "**MSQ**" means the Mental Status Questionnaire.

(13) "**MSQ moderate risk range**" means a total weighted-score of seven (7) to eleven (11) that indicates an orientation-memory-concentration impairment or memory impairment.

(14) "**Nutrition moderate risk**" means a total weighted UCAT Nutrition score is eight (8) or greater that indicates poor appetite or weight loss combined with special diet requirements, medications, or difficulties in eating.

(15) "**Social Resource score is eight (8) or more**" means the applicant or member lives alone, has no informal support when he or she is sick or needs assistance, or has little or no contact with others.

(c) **Medical eligibility minimum criteria for SPPC.** The medical eligibility minimum criteria for SPPC services are the minimum UCAT score criteria that an applicant or member meets for medical eligibility and are:

(1) ADLs score is five (5) or greater; or has an IADLs score of eight (8) or greater; or Nutrition score is (8) or greater; or the MSQ score is seven (7) or greater; or the ADLs score is three (3) and IADLs score is at least six (6); and

(2) Applicant or Member Support score is fifteen (15) or more; or Applicant or Member Support score is five (5) and the Social Resources score is eight (8) or greater.

(d) **Medical eligibility determination.** OKDHS HCMN III determines medical eligibility for SPPC services utilizing the UCAT.

(1) Categorical relationship is established for SPPC services financial eligibility determination.

(A) When categorical relationship to Aid to the Disabled is not established, but there is an extremely emergent need for personal care, and current medical information is not available, the local office authorizes a medical examination.

(B) When authorization is necessary, the county director issues Form 08MA016E, Authorization for Examination, and Form 08MA02E, Report of Physician's Examination, to a licensed medical or osteopathic health care professional, refer to Oklahoma Administrative Code (OAC) 317:30-5-1.

(C) The licensed health care professional cannot be in a medical facility internship, residency, or fellowship program or in the full-time employment of the Veterans Administration, United States Public Health Service, or other agency.

(D) The OKDHS county worker submits the information to the Level of Care Evaluation Unit (LOCEU) to request a medical eligibility determination for categorical relationship. LOCEU renders a decision on the categorical relationship using the Social Security Administration (SSA) definition. The OKDHS county worker is required to conduct a follow-up with SSA to ensure the SSA disability decision is also the LOCEU decision.

(2) Approved contract agencies or the ADvantage Administration (AA) may complete the electronic application. This alerts the social services specialist (SSS) of application date.

(3) Upon referral receipt, OKDHS SSS starts the financial eligibility determination.

(4) The OKDHS HCMN I or II is responsible for completing the UCAT assessment visit within ten (10) business days of the ~~personal care~~in-home application for the applicant who is SoonerCare eligible at the time of the request. The OKDHS HCMN I or II completes the assessment visit within twenty (20) business days of the referral for the applicant not determined SoonerCare eligible at the time of the request. When the application indicates the request is from an individual who resides at home and an immediate response is required to ensure the applicant's health and safety, to prevent an emergency situation, or to avoid institutional placement, the UCAT assessment visit has top-scheduling priority.

(A) For initial level of care (LOC) for applicants younger than eighteen (18) years of age, the OKDHS nurse assesses applicants through a face-to-face visit using the UCAT.

(B) For initial LOC for applicants eighteen (18) years of age or older, the OKDHS nurse assesses applicants through electronic format, such as phone or video conference, using the UCAT unless there are limiting factors which necessitate a face-to-face assessment.

(i) The OKDHS nurse determines LOC based upon the assessment outcome unless the applicant is medically ineligible. In this case, a face-to-face visit is scheduled to either validate the initial electronic format assessment or to provide additional documentation to support the applicant meeting medical LOC.

(ii) Applicants are not medically denied access to services solely based on the assessment completed through an electronic format.

(5) During the assessment visit, the OKDHS HCMN I or II completes the UCAT and reviews

rights to privacy, fair hearing, provider choice, and the pre-service acknowledgement agreement with the member. The OKDHS HCMN I or II gives the applicant information about medical eligibility criteria and OKDHS long-term care service options. OKDHS HCMN I or II documents if the member wants to be considered for nursing facility level of care services or if the member is applying for a specific service program on the UCAT. When, based on the information obtained during the assessment, the OKDHS HCMN I or II determines if the member may be at risk for health and safety, an immediate referral is made to Adult Protective Services or Child Protective Services, as applicable. The referral is documented on the UCAT.

(A) When SPPC services are not sufficient to meet the applicant's or member's needs, the OKDHS HCMN I or II provides information about other community long-term care service options. The OKDHS HCMN I or II assists in accessing service options applicant or member selects in addition to, or in place of, SPPC services.

(B) When multiple household members are applying for SoonerCare SPPC services, the UCAT assessment is done for all the household members at the same time.

(C) The OKDHS HCMN I or II provides the applicant or member with information about the qualified agencies in his or her local area that provide services and obtains the applicant's or member's primary and secondary agency choice. When the applicant or family declines to choose a primary personal care service agency, the round-robin rotation system is used for agency selection. The OKDHS HCMN I or II documents the selected personal care provider agency's name.

(6) The OKDHS HCMN I or II completes the UCAT in the electronic system, and the OKDHS HCMN III makes the medical eligibility determination. SPPC service eligibility is established on the date medical eligibility is approved and financial eligibility is established. This date serves as the certification date for services to be initiated.

(A) When the time length from the initial assessment to the date of service eligibility determination exceeds ninety (90) calendar days, a new UCAT assessment is required.

(B) The OKDHS HCMN III assigns a medical certification period of not more than thirty-six (36) months for persons eighteen (18) years of age and older or not more than twelve (12) months for persons younger than eighteen (18) years of age. The service plan period is for twelve (12) months.

(7) The SSS is notified via the electronic system of the personal care certification.

(8) Upon establishing SPPC certification, the OKDHS HCMN I or II notifies the applicant's or member's preferred provider agency, or when necessary, the secondary provider agency or the provider agency selected by the round robin rotation system. Within one (1) business day of provider agency acceptance, the OKDHS HCMN I or II submits the information via electronic system to the provider agency for plan development. Refer to OAC 317:35-15-8(a).

(9) Following the provider agency's SPPC plan development, and within three (3) business days of receipt from the provider agency, the OKDHS HCMN I or II reviews the documentation to ensure agreement with the plan. Once agreement is established, the plan is authorized or submitted to the OKDHS HCMN III for review.

(10) Within ten (10) business days of the SPPC plan receipt from the OKDHS HCMN I or II, the OKDHS HCMN III authorizes or denies the plan units. If the plan fails to meet standards for authorization, it is returned to the OKDHS HCMN I or II for further justification.

(11) Within one (1) business day of knowledge of the authorization, the OKDHS HCMN I or II submits the plan authorization to the provider agency via electronic system.

317:35-15-8. Agency State Plan Personal Care (SPPC) service authorization and monitoring

(a) Within ten (10) business days of referral receipt for SPPC services, the personal care provider agency nurse completes an assessment of the member's personal care service needs and completes and submits a person-centered plan based on the member's needs to the Oklahoma Human Services (OKDHS) Health Care Management Nurse (HCMN) I or II. The plan includes the:

- (1) Adv/SPPC-Nurse Evaluation;
- (2) SPPC-Service Planning; and
- (3) SPPC Member Service Agreement.

(b) When more than one (1) person in the household is referred to receive SPPC or ADvantage services, all household members' plans are discussed and developed with the eligible members, so service delivery is coordinated to achieve the most efficient use of resources. The number of SPPC service units authorized for each individual is distributed between all eligible family members. This ensures one (1) family member's absence does not adversely affect the family member(s) remaining in the home. When one (1) or more persons in the same household with a SPPC member is referred to or receives other formal services, such as ADvantage or Developmental Disability Services, then those services are coordinated as well.

(c) The personal care provider agency receives documentation from the OKDHS HCMN I or II for authorization to begin services. The agency provides a copy of the plan to the member upon initiating services.

(d) Prior to the provider agency placing a Personal Care Assistant (PCA) in the member's home or other service-delivery setting, an Oklahoma State Bureau of Investigation background check, an Oklahoma State Department of Health Registry check, and an OKDHS Community Services Worker Registry check is completed per Sections 1-1944 through 1-1948 of Title 63 of the Oklahoma Statutes. Payment is made for PCAs who provide SPPC services and meet ~~criteria~~ Oklahoma Administrative Code (OAC) 317:35-15-2(e)(d) (1) through (8) criteria.

(e) The provider agency nurse monitors the member's care plan.

(1) The personal care provider agency nurse or staff contacts the member within five (5) business days of authorized document receipt ~~in order~~ to ensure services are implemented according to the authorized care plan.

(2) The provider agency nurse makes a monitoring visit using the Adv/SPPC Nurse Evaluation at least every six (6) months to assess the member's satisfaction with his or her care and to evaluate the care plan for adequacy of goals and authorized units. Whenever a monitoring visit is made, the provider agency nurse documents findings in the electronic system. The provider agency submits monitoring documentation to the OKDHS HCMN I or II for review within five (5) business days of the visit. A registered nurse (RN) conducts the monitoring visit when the PCA is performing hands-on personal care. A licensed practical nurse may only conduct the monitoring visit when the PCA is not performing hands-on personal care. An RN also co-signs the progress notes.

(3) The provider agency nurse's requests to change the number of authorized units in the SPPC plan are submitted via the electronic system to the OKDHS HCMN III to approve or deny prior to changed number of authorized units implementation.

(4) Annually, or more frequently when the member's needs change, the provider agency nurse re-assesses the member's needs and develops a new plan to meet the member's needs. The provider agency nurse completes and submits the annual reassessment documents to the OKDHS HCMN I or II no sooner than sixty (60) calendar days before the existing service plan end-date, and no later than fourteen (14) calendar days prior to service.

(5) When the member is unstaffed, the provider agency nurse or staff communicates with the member and makes efforts to re-staff. When consecutively unstaffed for seven (7) calendar days, or fewer depending on the member's needs, the provider agency nurse or staff contacts the unstaffed member weekly by phone to actively monitor the member's health and safety and documents ongoing efforts to provide staff using the electronic system. When the member is unstaffed for thirty (30) days, the provider agency notifies the OKDHS HCMN I or II via the Case Note for SPPC thirty (30) day unstaffed note in the electronic system. The HCMN I or II contacts the member and when the member chooses, initiates a member transfer to another provider agency that can provide staff.

317:35-15-8.1. Agency State Plan Personal Care services; billing, and problem resolution

The ADvantage Administration (AA) certifies qualified personal care provider agencies and facilitates the execution of the agencies' SoonerCare (Medicaid) contracts on the Oklahoma Health Care Authority's (OHCA) behalf. OHCA checks the list of providers barred from Medicare/SoonerCare (Medicaid) participation to ensure that the personal care services agency is not listed.

(1) **Payment for State Plan Personal Care (SPPC).** Payment for SPPC services is made for care provided in the member's own home or in other limited living arrangement types, per Oklahoma Administrative Code (OAC) 317:35-15-2~~(b)~~(c) (1 through 45).

(A) **Provider agency use.** To provide SPPC services, an agency must be licensed by the Oklahoma State Department of Health, meets certification standards identified by Oklahoma Human Services (OKDHS), and possesses a current SoonerCare (Medicaid) contract.

(B) **Reimbursement.** SPPC services payment on a member's behalf is made according to the service type and number of authorized service units.

(i) The amount paid to provider agencies for each service unit is determined according to established SoonerCare (Medicaid) rates for the personal care services. Only authorized units contained in each eligible member's individual plan are eligible for reimbursement. Provider agencies serving more than one member residing in the same residence ensure the members' plans combine units in the most efficient manner to meet the needs of all eligible persons in the residence.

(ii) SPPC services payment is for tasks performed in accordance with the authorized care plan per OAC 317:30-5-951. Payment for personal care skilled nursing service is made on the member's behalf for assessment, evaluation, and associated service planning per nursing visit.

(iii) SPPC service time is documented through the Electronic Visit Verification System (EVV), previously known as Interactive Voice Response Authentication (IVRA) system, when services are provided in the home.

(2) Issue resolution.

(A) The provider agency provides a written copy of their grievance process to each member at service commencement. The written grievance process includes the name and phone number of a provider agency contact person who is responsible for responding to such complaints and grievances. When the member is dissatisfied with the SPPC provider agency or the assigned PCA and has exhausted attempts to work with the agency's grievance process without resolution, the member is referred to the OKDHS State Plan Care Unit to attempt to resolve the issue(s). The member has the right to appeal to OHCA

per OAC 317:2-1-2.

(B) When a PCA performance issue is identified, provider agency staff conducts a counseling conference with the member or the PCA as appropriate. Provider agency staff counsels the PCA regarding problems with his or her performance.

(3) **Persons ineligible to serve as a PCA.** Payment from SoonerCare funds for SPPC services may not be made to an individual who is a legally responsible family member of the member, such as a spouse, legal guardian, or parent of a minor child, when he or she is providing SPPC services.

317:35-15-10. Medical eligibility redetermination for State Plan Personal Care (SPPC) services

(a) **Medical eligibility redetermination.** The Oklahoma Human Services (OKDHS) Health Care Management Nurse (HCMN) III completes a medical redetermination before the end of the long-term care medical certification period.

(b) **Recertification.** The OKDHS HCMN I or II re-assesses the SPPC service members ~~eighteen (18) years of age and older~~, for medical re-certification based on the member's needs and level of caregiver support required, using the Uniform Comprehensive Assessment Tool (UCAT) ~~at least every thirty-six (36) months. Members younger than eighteen (18) years of age, are re-evaluated by the OKDHS HCMN I or II using the UCAT on a twelve (12) month basis or sooner when needed.~~ During this re-certification assessment, the OKDHS HCMN I or II informs the member of the state's other SoonerCare (Medicaid) long-term care options. The OKDHS HCMN I or II submits the re-assessment to the OKDHS HCMN III for recertification. Documentation is sent to the OKDHS area nurse no later than the tenth (10th) calendar day of the month certification expires. When the OKDHS HCMN III determines medical eligibility for SPPC services, a recertification review date is entered on the system.

(1) Members younger than eighteen (18) years of age are re-evaluated through a face-to-face visit by the OKDHS HCMN I or II using the UCAT on a twelve (12) month basis or sooner when needed.

(2) Members eighteen (18) years of age and older are re-evaluated by the OKDHS HCMN I or II using the UCAT at least every thirty-six (36) months through an electronic format, such as a phone or video conference, using the UCAT unless there are limiting factors which necessitate a face-to-face assessment.

(A) The OKDHS nurse determines level of care (LOC) based on the assessment's outcome unless the member is determined to be medically ineligible. In this case, a face-to-face visit is scheduled to either validate the electronic format assessment or provide additional documentation to support the member meeting medical LOC.

(B) Members are not medically denied access to services solely based on an assessment completed through an electronic format.

(c) **Change in amount of units or tasks.** When the SPPC provider agency determines a need for a change in the amount of units or tasks in the service, a care plan is completed and submitted to OKDHS within five (5) business days of identifying the assessed need. The OKDHS HCMN III approves or denies the change prior to implementation.

(d) **SPPC services voluntary closure.** When a SPPC member decides personal care services are no longer needed to meet his or her needs, a medical decision is not needed. The member is sent a Voluntary Withdrawal Request for confirmation and signature, and the request is entered into the electronic system upon receipt. A closure notification is submitted to the provider agency via the

electronic system.

(e) **Resuming personal care services.** When a SPPC member approved for SPPC services is without services for less than ninety (90) calendar days, but the member has current medical and SoonerCare (Medicaid) financial eligibility approval, SPPC services may be resumed using the member's previously approved plan. The personal care provider agency nurse contacts the member to determine when changes in health or service needs occurred. When changes are identified, the provider agency nurse completes an assessment visit and submits a SPPC services skilled nursing need re-assessment within ten (10) business days of the resumed plan start date. When the member's needs dictate, the personal care provider agency may submit a request for a change in authorized SPPC service units. When no changes occur, the agency nurse documents the contact in the electronic system for the OKDHS HCMN I or II ten (10) business days ~~of~~ before the resumed plan start date.

(f) **Financial ineligibility.** When the OKDHS social services specialist (SSS) determines a member does not meet SoonerCare (Medicaid) financial eligibility criteria, the OKDHS HCMN III is notified to initiate the closure process due to financial ineligibility. When OKDHS determines a member to be financially ineligible for SPPC services, they notify the member of the determination, and his or her right to appeal the decision in writing. A closure notification is submitted to the provider agency.

(g) **Closure due to medical ineligibility.** When OKDHS determines a member to be medically ineligible for SPPC services, they notify the member of the determination, and his or her right to appeal the decision, in writing. When medical eligibility redetermination is not made prior to current medical eligibility expiration, the existing medical eligibility certification is automatically extended until care level redetermination is established. For members:

(1) Who are not hospitalized or in an extended medical care facility, the existing medical eligibility certification is extended for a maximum sixty (60) calendar days from the date of the previous medical eligibility expiration date;

(2) Who are hospitalized or in an extended medical care facility, the existing medical eligibility certification is extended for thirty (30) calendar days from the date of discharge from the facility or for sixty (60) calendar days from the date of previous medical eligibility expiration date, whichever is longer;

(3) Whose medical eligibility redetermination is not made by applicable extended deadline, the member is determined to be medically ineligible; or

(4) Who no longer meet medical eligibility or cannot be located to complete the redetermination assessment, the HCMN I or II notifies the HCMN III. The HCMN III updates the system's medical eligibility end date and notifies the HCMN I or II of the effective end date. A closure notification is submitted to the provider agency.

(h) **State Plan Personal Care services termination.**

(1) State Plan Personal Care (SPPC) services may be discontinued when:

(A) Professional documentation supports the member poses a threat to self or others;

(B) Other household members or persons who routinely visit the household who, as professional or credible documentation supports, pose a threat to the member or other household visitors;

(C) The member or the other household members use threatening, intimidating, degrading, or sexually inappropriate language or innuendo or behavior towards service providers, either in the home or through other contact or communications. Efforts to correct such behavior are unsuccessful as professional or credible documentation supports;

(D) The member or family member fails to cooperate with SPPC service delivery or to

comply with Oklahoma Health Care Authority (OHCA) or OKDHS rules as professional or credible documentation supports;

(E) The member's health or safety is at risk as professional or credible documentation supports;

(F) Additional services, either "formal" such as, paid by Sooner Care (Medicaid) or some other funding source or "informal" such as, unpaid are provided in the home. This eliminates the need for SoonerCare SPPC services;

(G) The member's living environment poses a physical threat to self or others as professional or credible documentation supports, and measures to correct hazardous conditions or assist the person to move are unsuccessful or are not feasible; or

(H) The member refuses to select or accept a provider agency or Personal Care Assistant (PCA) service for ninety (90) consecutive days as professional or credible documentation supports.

(2) For members receiving SPPC services, the provider agency submits documentation with the recommendation to discontinue services to OKDHS. The OKDHS HCMN I or II reviews the documentation and submits it to the OKDHS HCMN III for determination. The personal care provider agency or PCA and the local OKDHS social services specialist ~~is~~are notified of the decision to terminate services via the electronic system. The member is sent an official closure notice informing him or her of appropriate member rights to appeal the decision to discontinue services.

317:35-15-13.1. Individual personal care assistant (IPCA) service management [REVOKED]

~~(a) An Individual Personal Care Assistant (IPCA) may be utilized to provide SPPC services when it is documented to be in the member's best interest to have an IPCA, or when there are no qualified personal care provider agencies available in the member's local area. Oklahoma Health Care Authority (OHCA) checks the list of providers barred from Medicare/Medicaid participation to ensure the IPCA is not listed.~~

~~(b) After SPPC services eligibility is established, and prior to implementation of SPPC services using an IPCA, the OKDHS Health Care Management Nurse I or II reviews the care plan with the member and IPCA and notifies them to begin SPPC services delivery. The OKDHS HCMN I or II maintains the original care plan and forwards a copy to the selected IPCA and member within one (1) business day of approval receipt.~~

~~(c) The HCMN I or II contacts the member within five (5) business days to ensure services are in place and meeting the member's needs. The HCMN I or II also monitors the care plan for members with an IPCA. For any member receiving SPPC services utilizing an IPCA, the OKDHS HCMN I or II makes a home visit at least every six (6) months beginning within ninety (90) calendar days from the date of service initiation. OKDHS HCMN I or II assesses the member's satisfaction with his or her SPPC services and evaluates the care plan for adequacy of goals and units allocated. Requests for changes in the units authorized in the care plan are approved by the HCMN III prior to implementation.~~

317:35-15-13.2. Individual personal care assistants (IPCA) provider contractor; billing, training, and problem resolution [REVOKED]

~~While the Oklahoma Health Care Authority (OHCA) is the contractor authorized under federal law, the Oklahoma Human Services (OKDHS) Health Care Management Nurse (HCMN) I or II initiates initial contracts with eligible members to provide SPPC services per Oklahoma~~

Administrative Code (OAC) 317:35-15-2. OHCA is responsible for IPCA contract renewal.

~~(1) **IPCA payment.** Payment for SPPC services is made for care provided in the member's own home or in other limited types of living arrangements per OAC 317:35-15-2(b)(1) through (4). SPPC services may not be approved when the member lives in the Personal Care Assistant's (PCA) home, except with the approval of OKDHS Community Living, Aging and Protective Services.~~

~~(A) **Reimbursement.** Personal care payment for a member is made according to the number of personal care units identified in the service plan.~~

~~(i) The amount per unit paid to individual contractors is determined according to the established rates. A service plan is developed for each member in the home and service units are assigned to meet each member's needs. The service plans combine units efficiently to meet all eligible members needs in the household.~~

~~(ii) From the total amounts the IPCA bills in (i) of this subparagraph, OHCA, acting as agent for the member employer, withholds the appropriate FICA tax percentage and sends it to the Internal Revenue Service as the individual contractor's contribution toward Social Security coverage. To ensure the Social Security account is credited, the individual contractor's Social Security number is entered correctly on each claim.~~

~~(iii) The contractor payment fee covers all SPPC services included on the service and care plans the OKDHS HCMN I or II develops. Payment is only made for eligible members' direct services and care. The OKDHS HCMN III, authorizes the number of service units the member receives.~~

~~(iv) A member may select more than one (1) IPCA. The service and care plan indicates when this is necessary.~~

~~(v) The IPCA may provide SoonerCare SPPC services for several households during one (1) week as long as the daily number of paid service units does not exceed eight (8) hours, thirty-two (32) units per day. Total weekly hours cannot exceed forty (40), one hundred and sixty (160) units.~~

~~(B) **IPCA wage or employment information release.** Any inquiry received by the local office requesting wage or employment information is forwarded to OHCA, Claims Resolution.~~

~~(2) **IPCA member selection.** Members or family members recruit, interview, conduct reference checks, and select applicants for IPCA consideration. Prior to placing an IPCA in the member's home, an Oklahoma State Bureau of Investigation (OSBI) background check and an OKDHS Community Services Worker Registry check are completed per Section 1-1944 through 1-1948 of Title 63 of the Oklahoma Statutes (O.S. 63 " 1-1944 through 1-948). The OKDHS HCMN I or II also checks the Certified Nurse Aide Registry. The OKDHS HCMN I or II affirms the applicant's name is not contained on any of the registries. The OKDHS HCMN I or II notifies OHCA when the applicant is on any registry.~~

~~(A) **Persons eligible to serve as IPCAs.** SPPC services payment is made IPCAs who meet the criteria per OAC 317:35-15-2(c)(1) through (8).~~

~~(B) **Persons ineligible to serve as IPCAs.** SPPC services payment from SoonerCare funds may not be made to an individual who is the member's legally responsible family member, such as a spouse, legal guardian, or parent of a minor child of the member being served.~~

~~(i) Payment cannot be made to or an OKDHS or OHCA employee. Payment cannot be made to an immediate family member of a an OKDHS employee who works in the same county without OKDHS Medicaid Services Unit approval. When a family~~

member relationship exists between an OKDHS HCMN I or II and an IPCA in the same county, the OKDHS HCMN I or II cannot manage services for a member whose IPCA is his or her family member.

(ii) If it is determined that an OKDHS HCMN I or II or an OHCA employee is interfering in service provision for personal or family benefit, the employee is subject to disciplinary action.

(3) IPCA orientation. When a member selects an IPCA, the OKDHS HCMN I or II notifies the selected IPCA to complete the Oklahoma State Department of Health (OSDH) Form 805, Uniform Employment Application for Nurse Aide Staff, and the OKDHS Form 06PE039E, Employment Application Supplement, and for a qualification determination and orientation determination. For SPPC members, this process is the OKDHS HCMN I or II responsibility. The IPCA can begin work after:

- (A) The member interviews him or her;
- (B) The OKDHS nurse orients him or her;
- (C) A contract (OHCA-0026) is executed with the OHCA;
- (D) The effective service date is established;
- (E) All registries are checked and the IPCA's name is not listed;
- (F) OSDH Nurse Aide Registry is checked and no notations are found; and
- (G) OSBI background check is completed.

(4) IPCA training. It is the OKDHS HCMN I or II responsibility to make sure the IPCA has the training needed to carry out the care plan prior to each member's service initiation.

(5) Problem resolution related to IPCA performance. When it comes to the OKDHS HCMN I or II attention there is a problem related to IPCA performance, a counseling conference is held between the member, OKDHS HCMN I or II, and IPCA. The OKDHS HCMN I or II counsels the IPCA regarding problems with his or her performance when doing so results in improved performance.

(6) IPCA Provider Agreement termination.

(A) An IPCA contract termination recommendation is submitted to OHCA and IPCA services are suspended immediately when the IPCA:-

- (i) Performance poses a threat to the member's health and safety or to others; or
- (ii) Failed to comply with PCA Provider Agreement expectations and counseling is not appropriate or effective; or
- (iii) Name appears on the OKDHS Community Services Worker Registry or any registry listed in O.S. 63-1-1947, even when his or her name is not on the registry at the time of application or hiring.

(B) The OKDHS HCMN makes the IPCA termination recommendation to OKDHS Community Living, Aging and Protective Services Medicaid Services Unit (MSU), MSU then notifies the OHCA Legal Division of the recommendation. When the problem is related to abuse, neglect, or exploitation allegations OKDHS Adult Protective Services, State Attorney General's Medicaid Unit, OHCA, and OSDH are notified.

(C) When the problem is related to abuse, neglect, or exploitation allegations, the OKDHS HCMN follows the process, per OAC 340:100-3-39.

SUBCHAPTER 16. STATE PLAN PERSONAL CARE SERVICES FOR EXPANSION ADULTS, TEFRA AND CERTAIN MAGI POPULATIONS

317:35-16-3. General financial eligibility requirements for State Plan Personal Care [REVOKED]

~~Financial eligibility for SPPC is determined using the rules on income and resources according to the eligibility group the member is related to.~~

317:35-16-4. Determining financial eligibility of categorically needy individuals [REVOKED]

~~Financial eligibility for State Plan Personal Care (SPPC) services for categorically needy individuals is determined as follows:~~

- ~~(1) **Financial eligibility for Modified Adjusted Gross Income (MAGI) eligibility groups.** See MAGI eligibility rules in Subchapter 6 of this Chapter to determine financial eligibility.~~
- ~~(2) **Determining financial eligibility for State Plan Personal Care (SPPC).** For individuals determined categorically needy for SPPC, the member will not pay a vendor payment for SPPC services.~~

SUBCHAPTER 17. ADVANTAGE WAIVER SERVICES

317:35-17-2. Level of care medical eligibility determination

The Oklahoma Human Services (OKDHS) area nurse, or nurse designee, determines medical eligibility for ADvantage program services based on the Uniform Comprehensive Assessment Tool (UCAT) ~~H~~-assessment and the determination that the member has unmet care needs that require ADvantage or NFnursing facility (NF) services to assure member health and safety. ADvantage services are initiated to support the informal care that is being provided in the member's home, or, that based on the UCAT, can be expected to be provided in the ~~members'~~member's home upon discharge of the member from a NF or hospital. These services are not intended to take the place of regular care and general maintenance tasks or meal preparation typically shared or done for one another by spouses or other adults ~~and~~ who live in the same household. Additionally, services are not furnished if they principally benefit the family unit. When there is an informal (not paid) system of care available in the home, ADvantage service provision will supplement the system within the limitations of ADvantage Program policy to enable the family and/or significant others to continue caregiving over extended periods. ~~When the ADvantage personal care attendant and member live within the same household, personal care will only be approved by agreement of the interdisciplinary service planning team and OKDHS AA approval that the personal care tasks are consistent with plan goals and have beneficial outcomes for the member.~~

(1) **Definitions.** The following words and terms when used in this subchapter, shall have the following meaning, unless the context clearly indicates otherwise:

(A) "ADL" means the activities of daily living. Activities of daily living are activities that reflect the member's ability to perform self-care tasks essential for sustaining health and safety such as:

- (i) bathing,
- (ii) eating,
- (iii) dressing,
- (iv) grooming,
- (v) transferring (includes getting in and out of a tub, bed to chair, etc.),
- (vi) mobility,
- (vii) toileting, and
- (viii) bowel/bladder control.

(B) **"ADLs score in high risk range"** means the member's total weighted UCAT ADL score is 10 or more which indicates the member needs some help with 5 ADLs or that the member cannot do 3 ADLs at all plus the member needs some help with 1 other ADL.

(C) **"ADLs score at the high end of the moderate risk range"** means member's total weighted UCAT ADL score is 8 or 9 which indicates the member needs help with 4 ADLs or the member cannot do 3 ADLs at all.

(D) **"Client Support high risk"** means member's UCAT Client Support score is 25 which indicates in the UCAT assessor's clinical judgment, excluding from consideration existing Ryan White CARE Act, Indian Health Service, Medicaid NF, ADvantage and/or State Plan Personal Care services, very little or no support is available from informal and formal sources and the overall total support is entirely inadequate to meet a high degree of medically complex needs. Functional capacity is so limited as to require full time assistance and the stability of the care system is likely to fail. The member requires additional care that is not available through Medicare, Veterans Administration, or other Federal entitlement programs to prevent an imminent risk of ~~life-threatening~~ life-threatening health deterioration or institutional placement.

(E) **"Client Support low risk"** means member's UCAT Client Support score is 5 which indicates in the UCAT assessor's clinical judgment, excluding from consideration existing Ryan White CARE Act, Indian Health Service, Medicaid NF, ADvantage and/or State Plan Personal Care services, support from informal and formal sources is nearly sufficient/stable with minimal or few needs for formal services (i.e., some housekeeping only). The member/family/informal supports are meeting most needs typically expected for family/household members to share or do for one another, i.e., general household maintenance. There is little risk of institutional placement even with a loss of current supports.

(F) **"Client Support moderate risk"** means member's UCAT Client Support score is 15 which indicates in the UCAT assessor's clinical judgment, excluding from consideration existing Ryan White CARE Act, Indian Health Service, Medicaid NF, ADvantage and/or State Plan Personal Care services, support from informal and formal sources is available, but overall, it is inadequate, changing, fragile or otherwise problematic and the member requires additional care that usually includes personal care assistance with one or more activity of daily living tasks and is not available through Medicare, Veterans Administration, or other federal entitlement programs. Support provided by informal caregivers is of questionable reliability due to one or more of the following:

- (i) Care/support is required continuously with no relief or backup available, or
- (ii) Informal support lacks continuity due to conflicting responsibilities such as job and/or child care, or
- (iii) Care/support is provided by persons with advanced age and/or disability, and
- (iv) Institutional placement can reasonably be expected with any loss of existing support.

(G) **"Cognitive Impairment"** means that the individual, as determined by the clinical judgment of the OKDHS Nurse or the AA, does not have the capability to think, reason, remember or learn skills required for self-care, communicating needs, directing ~~care~~ caregivers and/or using appropriate judgment for maintenance of their own health or safety. The clinical judgment of cognitive impairment is based on MSQ performance in combination with a more general evaluation of cognitive function from interaction with the

individual during the UCAT assessment.

(H) "**Developmental Disability**" means a severe, chronic disability of an individual that:

- (i) is attributable to a mental or physical impairment or combination of mental and physical impairments;
- (ii) is manifested before the individual attains age 22;
- (iii) is likely to continue indefinitely;
- (iv) results in substantial functional limitations in three or more of the following areas of major life activity:

- (I) self-care;
- (II) receptive and expressive language;
- (III) learning;
- (IV) mobility;
- (V) self-direction;
- (VI) capacity for independent living; and
- (VII) economic self-sufficiency; and

(v) reflects the individual's need for a combination and sequence of special, interdisciplinary, or generic services, supports, or other assistance that is of lifelong or extended duration and is individually planned and coordinated.

(I) "**Environment high risk**" means member's UCAT Environment score is 25 which indicates in the UCAT assessor's clinical judgment, the physical environment is strongly negative or hazardous.

(J) "**Environment low risk**" means member's UCAT Environment score is 5 which indicates in the UCAT assessor's clinical judgment that, although aspects of the physical environment may need minor repair/improvement, the physical environment poses little risk to member's health and/or safety.

(K) "**Environment moderate risk**" means member's UCAT Environment score is 15 which indicates in the UCAT assessor's clinical judgment, many aspects of the physical environment are substandard or hazardous.

(L) "**Health Assessment high risk**" means member's UCAT health assessment score is 25 which indicates in the UCAT assessor's clinical judgment, the member has one or more chronic health conditions, whose symptoms are rapidly deteriorating, uncontrolled, or not well controlled and ~~requiring~~requires a high frequency or intensity of medical care/oversight to bring under control and whose functional capacity is so limited as to require full time assistance or care performed daily, by, or under the supervision of professional personnel and has multiple unmet needs for services available only through the ADvantage program or a Nursing Facility (NF) and requires NF placement immediately if these needs cannot be met by other means.

(M) "**Health Assessment low risk**" means member's health assessment score is 5 which indicates, in the UCAT assessor's clinical judgment, the member has one or more chronic, stable, health conditions, whose symptoms are controlled or nearly controlled, which benefit from available, or usually available, medical treatment or corrective measures, and may have an unmet need for a service available only through the ADvantage program or a Nursing Facility (NF) but is not likely to enter a NF if these needs are not met.

(N) "**Health Assessment moderate risk**" means member's UCAT Health Assessment score is 15 which indicates in the UCAT assessor's clinical judgment, the member has one or more chronic changing health conditions, whose symptoms are fragile or worsening and

require medical care/oversight, to bring under control or to maintain in a stable, controlled state and has multiple unmet needs for services available only through the ADvantage program or a Nursing Facility (NF) and is likely to enter a NF if these needs are not met.

(O) **"IADL"** means the instrumental activities of daily living that reflect household chores and tasks within the community essential for sustaining health and safety such as:

- (i) shopping,
- (ii) cooking,
- (iii) cleaning,
- (iv) managing money,
- (v) using a telephone,
- (vi) doing laundry,
- (vii) taking medication, and
- (viii) accessing transportation.

(P) **"IADLs score in high risk range"** means member's total weighted UCAT IADL score is 12 or more which indicates the member needs some help with 6 IADLs or cannot do 4 IADLs at all.

(Q) **"Intellectual Disability"** means that the individual has, as determined by a standardized testing by trained professionals, substantial limitations in functional ability due to significantly sub-average intellectual functioning related to an event occurring before the age of 18.

(R) **"MSQ"** means the mental status questionnaire.

(S) **"MSQ score in high risk range"** means the member's total weighted UCAT MSQ score is 12 or more which indicates a severe orientation-memory-concentration impairment, or a severe memory impairment.

(T) **"MSQ score at the high end of the moderate risk range"** means the member's total weighted UCAT MSQ score is (10) or (11) which indicates an orientation-memory-concentration impairment, or a significant memory impairment.

(U) **"Nutrition high risk"** means a total weighted UCAT Nutrition score is 12 or more which indicates the member has significant eating difficulties combined with poor appetite, weight loss, and/or special diet requirements.

(V) **"Progressive degenerative disease process that responds to treatment"** means a process such as, but not limited to, Multiple Sclerosis (MS), Parkinson's Disease, Human Immunodeficiency Virus (HIV), or Acquired Immunodeficiency Syndrome (AIDS), that, untreated, systematically impairs normal body function which leads to acute illness and/or disability that results in rapid and/or advanced effects beyond those of regular chronic disease degeneration but that reacts positively to a medically prescribed treatment intervention (usually medication) which arrests or significantly delays the destructive action of the process.

(W) **"Reauthorization"** means the official approval by the AA of an ADvantage member's Service Plan after the approval/authorization of the member's initial, or first year, Service Plan. At a minimum, reauthorization of an ADvantage member's Service Plan is required every 12 months.

(X) **"Recertification"** means the formal certification of medical and/or financial eligibility for an ADvantage member by OKDHS within ~~ELDERS and IMS~~ the electronic systems upon completion of the annual review.

(Y) **"Redetermination of eligibility"** means a subsequent determination of eligibility for

an ADvantage member after the initial eligibility decision. Redetermination of financial and medical eligibility for ADvantage members is required at a minimum of once every 12 months. A redetermination of Program Eligibility, although not required, may occur when a significant change in the service plan is authorized or a significant change in the living arrangement occurs.

(Z) "**Social Resources high risk**" means a total weighted UCAT Social Resources score is 15 or more, which indicates the member lives alone, combined with none or very few social contacts and no supports in times of need.

(2) **Minimum UCAT criteria.** The minimum UCAT criteria for NF level of care ~~criteria~~ are:

(A) Care need: The UCAT documents need for assistance to sustain health and safety as demonstrated by:

(i) either the ADLs or MSQ score is in the high risk range; or

(ii) any combination of two or more of the following:

(I) ADLs score is at the high end of moderate risk range; or,

(II) MSQ score is at the high end of moderate risk range; or,

(III) IADLs score is in the high risk range; or,

(IV) Nutrition score is in the high risk range; or,

(V) Health Assessment is in the moderate risk range, and, in addition;

(B) Loss of independence: The UCAT documents absence of support or adequate environment to meet the needs to sustain health and safety as demonstrated by:

(i) Member Support is moderate risk; or,

(ii) Environment is high risk; or,

(iii) Environment is moderate risk and Social Resources is in the high risk range; or, regardless of whether criteria under (A) of Care need and (B) Loss of independence;

(C) Expanded criteria: The UCAT documents that:

(i) the member has a clinically documented progressive degenerative disease process that will produce health deterioration to an extent that the individual will meet OAC 317:35-17-2(2)(A) criteria if untreated; and

(ii) the member previously has required Hospital or NF level of care services for treatment related to the condition; and

(iii) a medically prescribed treatment regimen exists that will significantly arrest or delay the disease process; and

(iv) only by means of ADvantage Program eligibility will the individual have access to the required treatment regimen to arrest or delay the disease process.

(3) **NF Level of Care Services.** To be eligible for NF level of care services, meeting the minimum UCAT criteria demonstrates the individual must:

(A) require a treatment plan involving the planning and administration of services that require the skills of licensed or otherwise certified technical or professional personnel, and are provided directly or under the supervision of such personnel;

(B) have a physical impairment or combination of physical, mental and/or functional impairments;

(C) require professional nursing supervision (medication, hygiene and/or dietary assistance);

(D) lack the ability to adequately and appropriately care for self or communicate needs to others;

(E) require medical care and treatment in order to minimize physical health regression or

deterioration;

(F) require care that is not available through family and friends, Medicare, Veterans Administration, or other federal entitlement program with the exception of Indian Health Services.

317:35-17-4. Application for ADvantage services

(a) **Application procedures for ADvantage services.** ~~If waiver slots are available, the application process is initiated by the receipt of a UCAT, Part I or by an oral request~~ initiates when an online application is completed for ADvantage services. A written financial application is not required for an individual who has an active Medicaid case. A financial application for ADvantage services consists of the Medical Assistance Application form. The form is signed by the applicant, parent, spouse, guardian, or someone else acting on the applicant's behalf.

(1) All conditions of financial eligibility must be verified and documented in the case record. When current information already available in the local office establishes financial eligibility, such information may be used by recording source and date of information. If the applicant also wishes to apply for a State Supplemental Payment, either the applicant or his/her guardian must sign the application form.

(2) When Medicaid application is being made, an assessment of resources must be completed. For applicants of the ADvantage waiver, those resources owned by the couple the month the application was made determines the spousal share of resources.

(3) When an application is received from an individual residing in a nursing facility, the applicant is referred to the Oklahoma Health Care Authority (OHCA) Living Choice program as the appropriate entity to assist individuals from nursing facility care.

(A) If OHCA Living Choice determines the applicant is ineligible for services due to the inability to assure health and welfare in a community setting, the individual is also ineligible for ADvantage waiver services.

(B) If OHCA Living Choice determines the applicant does not meet Living Choice eligibility criteria for reasons unrelated to health and welfare, the individual is eligible for the ADvantage waiver if medically and financially approved.

(b) Date of application.

(1) The date of application is:

(A) the date the applicant or someone acting in his/her behalf signs the application in the county office; or

(B) the date the application is stamped into the county office when the application is initiated outside the county office; or

(C) the date when the request for Medicaid is made orally and the financial application form is signed later. The date of the oral request is entered in "red" above the date the form is signed.

(2) An exception is when OKDHS has contracts with certain providers to take applications and obtain documentation. After the documentation is obtained, the contracted provider forwards the application and documentation to the OKDHS county office of the applicant's county of residence for Medicaid eligibility determination. The application date is the date the applicant signed the application form for the provider.

(c) **ADvantage waiting list procedures.** ADvantage Program "available capacity" is the number of members that may be enrolled in the Program without exceeding, on an annualized basis, the maximum number authorized by the waiver to be served in the waiver year. Upon notification from

the AA that 90% of the available capacity has been exceeded, OKDHS ~~Aging Services Division (OKDHS/ASD)~~ Community Living, Aging and Protective Services notifies OKDHS county offices and contract agencies approved to complete the UCAT, ~~Parts I and II~~ that, until further notice, requests for ADvantage services are not to be processed as applications, but referred to AA to be placed on a waiting list of requests for ADvantage services. As available capacity permits, but remaining in compliance with waiver limits of maximum capacity, and until an increase in ADvantage available capacity occurs, the AA selects in chronological order (first on, first off) requests for ADvantage from the waiting list to forward to the appropriate OKDHS county office for processing the application. When the waiver capacity exceeds the number on the waiting list and after all persons on the waiting list have been processed, waiting list procedures are suspended.

317:35-17-5. ADvantage program medical eligibility determination

The Oklahoma of Human Services (OKDHS) area nurse or nurse designee, makes the medical eligibility determination utilizing professional judgment, the Uniform Comprehensive Assessment Tool (UCAT), and any other available medical information.

- (1) When ADvantage care services are requested or the application is received, the:
 - (A) OKDHS nurse completes the UCAT; and
 - (B) Social services specialist (SSS) contacts the applicant within three (3) business days to initiate the financial eligibility application process.
- (2) Categorical relationship is established for ADvantage services eligibility determination. When a member's categorical relationship to a disability is not established, the local SSS submits the same information, per Oklahoma Administrative Code (OAC) 317:35-5-4(2) to the Level of Care Evaluation Unit (LOCEU) of the Oklahoma Health Care Authority to request a medical categorical relationship eligibility determination. LOCEU decides on the categorical relationship to the disability using the Social Security Administration (SSA) definition. ~~An~~ SSS follow-up with SSA is required to ensure the disability decision agrees with the LOCEU decision.
- (3) Community agencies and waiver service applicants may complete the application and forward to OKDHS.
- (4) When an applicant is Medicaid eligible at the request time, an OKDHS nurse completes the UCAT assessment with the applicant within ten (10) business days of referral receipt for ADvantage services. The OKDHS nurse completes the UCAT assessment within twenty (20) business days of the date the Medicaid application is completed for new applicants.
- (5) For initial level of care (LOC), the OKDHS nurse assesses the applicant through an electronic format such as phone or video conference, using the UCAT, unless there are limiting factors which necessitate a face-to-face assessment.
 - (A) The OKDHS nurse determines LOC based upon the assessment outcome unless the applicant is medically ineligible. In this case, a face-to-face visit is scheduled to either validate the initial electronic format assessment or to provide additional documentation to support the applicant meeting medical LOC.
 - (B) Applicants are not medically denied access to the waiver solely based on an assessment completed through an electronic format.
- (6) During the UCAT assessment, the OKDHS nurse informs the applicant of medical eligibility criteria and provides information about the different long-term care service options. The OKDHS nurse documents whether the applicant chooses nursing facility program services or ADvantage program services and makes ~~an~~ LOC and service program recommendation.

(7) The OKDHS nurse informs the applicant and family of agencies certified to deliver ADvantage case management and in-home care services in the local area to obtain the applicant's primary and secondary informed provider choice, ensuring adherence to conflict free case management requirements.

(A) ADvantage providers, or those who have an interest in or are employed by an ADvantage provider, do not provide case management or develop the person-centered service plan. The only exception is when the ADvantage Administration demonstrates there are no more than two (2) willing and qualified entities to provide case management and develop person-centered service plans in a geographic area, and those agencies also provide other ADvantage services.

(B) When the applicant or family declines to make a provider choice, the OKDHS nurse documents the decision on the consents and rights document.

(C) OKDHS uses a rotating system to select agencies for the applicant from a list of all local, certified case management and in-home care providers, ensuring adherence to conflict free case management requirements.

(8) The OKDHS nurse documents chosen agency names, or the choice to decline to select agencies, and the applicant's agreement to receive waiver services.

(9) When the applicant's needs require an immediate interdisciplinary team (IDT) meeting with the case manager and home care provider agency nurse participation to develop a person-centered service plan, the OKDHS nurse documents the priority processing need.

(10) The OKDHS nurse forwards the completed UCAT to the area nurse or nurse designee for medical eligibility determination.

(11) When the OKDHS nurse determines the UCAT assessment indicates the member health and safety are at risk, OKDHS Adult Protective Services staff is notified immediately, and the referral is documented on the UCAT.

(12) Within ten (10) business days of receipt of a complete ADvantage application, the area nurse or nurse designee determines medical eligibility using nursing facility LOC criteria and service eligibility criteria, per OAC 317:35-17-2 and 317:35-17-3, and enters the medical decision on the system.

(13) Upon SSS financial eligibility notification and medical eligibility approval for ADvantage entry from the area nurse or nurse designee, AA communicates with the case management provider to begin care and service plan development. AA provides the member's demographic and assessment information, and the number of case management and home care nurse evaluation units authorized for service plan development. When the member requires an immediate home visit to develop a person-centered plan, AA contacts the case management provider directly to confirm availability and request IDT priority.

(14) When a member is being discharged from a ~~nursing facility or~~ hospital and transferred home, services are in place to ensure the member's health and safety. The member's chosen case manager follows the ADvantage institutional transition case management procedures for care, and service plan development and implementation.

(15) A new medical LOC determination is required when a member requests any change in service setting, from:

(A) State Plan Personal Care (SPPC) services to ADvantage services;

(B) ADvantage to SPPC services;

(C) Nursing facility to ADvantage services; or

(D) ADvantage to nursing facility services.

(16) A new medical LOC determination is not required when a member requests ADvantage services re-activation after staying ninety (90) calendar days or less in a nursing facility when the member had previous ADvantage services and the ADvantage certification period has not expired by the date the member is discharged. Individuals residing in a nursing facility may be referred to OHCA Living Choice for assistance in transitioning to the community, as needed.

(17) When a UCAT assessment is completed more than ninety (90) calendar days prior to submission to the area nurse or nurse designee for a medical decision, a new assessment is required.

317:35-17-14. Case management services

(a) Case management services involve ongoing assessment, service planning and implementation, service monitoring and evaluation, member advocacy, and discharge planning.

(1) Within one-business (1-business) day of receipt of an ADvantage referral from the ADvantage Administration (AA), the case ~~management supervisor~~processor assigns a case manager to the member. The case manager makes a home visit to review the ADvantage program, including its purpose, philosophy, and the roles and responsibilities of the member, service provider, case manager, and ~~the Oklahoma Department of Human Services (DHS OKDHS).~~ The case manager will review and or, when needed, update the Uniform Comprehensive Assessment Tool (UCAT) ~~Part III~~ and discuss service needs and ADvantage service providers. The case manager notifies the member's primary physician, identified in the UCAT ~~Part I~~, in writing that the member was determined eligible to receive ADvantage services. The notification is a preprint form that contains the member's signed permission to release this health information and requests physician's office verification of primary and secondary diagnoses and diagnoses code obtained from the UCAT ~~Part III~~.

(2) Within ~~fourteen calendar (14-calendar)~~10 business days of the receipt of an ADvantage referral, the case manager completes and submits a person-centered service plan for the member, signed by the member and the case manager, to the case manager supervisor for approval and submission to the AA. The case manager completes and submits the annual reassessment person-centered service plan documents at least thirty (30) days before, but no sooner than sixty ~~calendar~~calendar days (60-calendar) days before the existing service plan end-date but sufficiently in advance of the end-date to be received by the AA at least thirty (30) days before the end-date of the existing person-centered service plan. The case manager submits revisions for denied services to be resubmitted for approval within ~~five-business (5-business)~~seven-business (7-business) days to the AA. Within ~~fourteen calendar (14-calendar)~~ten-business (10-business) days of receipt of a Service Plan Review (SPR) notification of service conditions for short-term authorizations from the AA, the case manager submits ~~corrected person-centered service plan documentation~~the correction. Within ~~five-business (5-business)~~seven-business (7-business) days of assessed need, the case manager completes and submits a service plan ~~addendum~~change to the AA to amend current services ~~on the person-centered service plan.~~ The person-centered service plan is based on the member's service needs identified by the UCAT ~~Part III~~, and includes only those ADvantage services required to sustain and/or promote the health and safety of the member. The case manager uses an interdisciplinary team (IDT) planning approach for person-centered service plan development. ~~Except for extraordinary circumstances, the IDT meetings are held in the member's home. When home care is the primary service, the IDT~~ and includes, at a minimum, the member, ~~a nurse from the ADvantage home care or assisted living provider chosen by the member, and the case~~

~~manager. Otherwise, the member and case manager constitute a minimum IDT member's legal representative if applicable, case manager, and homecare Registered Nurse.~~

(3) The case manager identifies long-term goals, strengths and challenges for meeting goals, and service goals including plan objectives, actions steps and expected outcomes. The ~~ADvantage case manager documents on the person-centered service plan in the electronic case file the presence of two (2) or more ADvantage members residing in the same household and/or when the member and personal care provider reside together. The case manager documents on the Electronic Visit Verification (EVV) system in the member record any instance in which a member's health or safety would be at risk when even one (1) personal care visit is missed.~~ The case manager identifies services, service provider, funding source units and frequency of service and service cost, cost by funding source and total cost for ADvantage services. The member signs and indicates ~~review/agreement~~ review and agreement with the person-centered service plan by indicating acceptance or non-acceptance of the plans. The member, the member's legal guardian or legally authorized representative signs the person-centered service plan in the presence of the case manager. The signatures of two (2) witnesses are required when the member signs with a mark. When the member refuses to cooperate in development of the person-centered service plan or when the member refuses to sign the person-centered service plan, the case management agency refers the case to the AA for resolution. Based on the UCAT ~~Part III~~ and/or case progress notes that document chronic uncooperative or disruptive behaviors, the ~~DHSOKDHS~~ nurse or AA may identify members that require AA intervention through referral to the AA's Escalated Issues unit.

(A) For members that are uncooperative or disruptive, the case manager supports the member to develop an individualized person-centered service plan to overcome challenges to receiving services. This plan focuses on behaviors, both favorable and those that jeopardize the member's well-being and includes a design approach of incremental plans and addenda that allows the member to achieve stepwise successes in behavior modification.

(B) The AA may implement a person-centered service plan without the member's signature ~~when the presence of a document that requires their signature may itself trigger a conflict. In these circumstances, when~~ mental health/behavioral issues ~~may~~ prevent the member from controlling his or her behavior to act in his or her own interest. When the member, by virtue of level of care and the IDT assessment, needs ADvantage services to ensure his or her health and safety, the AA may authorize the person-centered service plan when the case manager demonstrates effort to work with and obtain the member's agreement. Should negotiations not result in agreement with the person-centered service plan, the member may withdraw his or her request for services or request a fair hearing.

(4) Consumer-Directed Personal Assistance Services and Supports (~~CD-PASS~~CDPASS) planning and supports coordination.

(A) ~~CD-PASS~~CDPASS offers ADvantage members personal choice and control over the delivery of their in-home support service, including who provides the services and how services are provided. Members or their legal representatives have singular "employer authority" in decision-making and are responsible to recruit, hire, train, supervise and when necessary, terminate the individuals who furnish their services. They also have "budget authority" to determine how expenditures of their expense accounts are managed.

(B) Members who elect the ~~CD-PASS~~CDPASS service option receive support from Consumer-Directed Agent/Case Manager (~~CDA/CM~~CDPASS CM) in directing their

services. The CDA/CMCDPASS CM liaison between the member and the program assists members, identifying potential requirements and supports as they direct their services and supports. ADvantage case management providers deliver required support and assign the CD-PASS members a case manager trained on the ADvantage CD-PASSCDPASS service option, independent living philosophy, person centered service planning, the role of the member as employer of record, the individual budgeting process and service plan development guidelines. A case manager, who has completed specialized CD-PASSCDPASS training, is referred to as a CDA/CMCDPASS CM with respect to the service planning and support role when working with CD-PASSCDPASS members. The CDA/CMCDPASS CM educates the member about his or her rights and responsibilities as well as community resources, service choices and options available to the member to meet CD-PASSCDPASS service goals and objectives.

(C) The ADvantage case management provider is responsible for ensuring that case managers serving members who elect to receive or are receiving the CD-PASSCDPASS service option have successfully completed CD-PASSCDPASS certification training in its entirety and have a valid CDA/CMCDPASS CM certification issued by the AA.

(D) Consumer-directed, SoonerCare (Medicaid)-funded programs are regulated by federal laws and regulations setting forth various legal requirements with which states must comply. The ADvantage case management provider is responsible for ensuring that CDA/CMsCDPASS CMs in their employment provide services to CD-PASSCDPASS members consistent with certification guidelines ~~so as to be in keeping with~~ following federal, state, and Waiver requirements. Non-adherence may result in remediation for the case management provider, the case manager, or both, up to and including decertification.

(E) Members may designate a family member or friend as an authorized representative to assist in the service planning process and in executing member employer responsibilities. When the member chooses to designate an authorized representative, the designation and agreement, identifying the willing adult to assume this role and responsibility, is documented with dated signatures of the member, the designee, and the member's case manager, or AA staff.

(i) A person having guardianship or power of attorney or other court-sanctioned authorization to make decisions on behalf of the member has legal standing to be the member's designated authorized representative.

(ii) An individual hired to provide CD-PASSCDPASS services to a member may not be designated the authorized representative for the member.

(iii) The case manager reviews the designation of authorized representative, power of attorney, and legal guardian status on an annual basis and includes this in the reassessment packet to AA.

(F) The CDA/CMCDPASS CM provides support to the member in the person-centered CD-PASSCDPASS planning process. Principles of person-centered planning are listed in (i) through (v) of the subparagraph.

(i) The ~~person~~member is the center of all planning activities.

(ii) The member and his or her representative, or support team are given the requisite information to assume a controlling role in the development, implementation, and management of the member's services.

(iii) The ~~individual~~member and those who know and care about him or her are the fundamental sources of information and decision-making.

- (iv) The ~~individual~~member directs and manages a planning process that identifies his or her strengths, capacities, preferences, desires, goals, and support needs.
- (v) Person-centered planning results in personally-defined outcomes.
- (G) The ~~CDA/CMCDPASS CM~~ encourages and supports the member, or as applicable his or her designated authorized representative, to lead, to the extent feasible, the ~~CD-PASS~~CDPASS service planning process for personal services assistance. The ~~CDA/CMCDPASS CM~~ helps the member define support needs, service goals, and service preferences including access to and use of generic community resources. Consistent with member-direction and preferences, the ~~CDA/CMCDPASS CM~~ provides information and helps the member locate and access community resources. Operating within the constraints of the Individual Budget Allocation (IBA) units, the ~~CDA/CMCDPASS CM~~ assists the member to translate the assessment of member needs and preferences into an individually tailored, person-centered service plan.
- (H) To the extent the member prefers, the ~~CDA/CMCDPASS CM~~ develops assistance to meet member needs using a combination of traditional personal care and ~~CD-PASS~~CDPASS Personal Service Assistant (PSA) services. However, the ~~CD-PASS~~CDPASS IBA and the PSA unit authorization is reduced ~~proportional~~proportionally to agency personal care service utilization.
- (I) The member determines with the PSA to be hired, a start date for PSA services. The member coordinates with the ~~CDA/CMCDPASS CM~~ to finalize the person-centered service plan. The start date must be after:
- (i) authorization of services;
 - (ii) completion and approval of the background checks; and
 - (iii) completion of the member employee packets.
- (J) Based on outcomes of the planning process, the ~~CDA/CMCDPASS CM~~ prepares an ADvantage person-centered service plan or plan amendment to authorize ~~CD-PASS~~CDPASS personal service assistance units consistent with this individual plan and notifies existing duplicative personal care service providers of the end-date for those services.
- (K) When the plan requires an Advanced Personal Service Assistant (APSA) to provide assistance with health maintenance activities, the ~~CDA/CMCDPASS CM~~ works with the member and, as appropriate, arranges for training by a skilled nurse for the member or member's family and the APSA to ensure that the APSA performs the specific health maintenance tasks safely and competently, when the:
- (i) member's APSA was providing Advanced Supportive Restorative Assistance to the member for the same tasks in the period immediately prior to being hired as the APSA, additional documentation of competence is not required; ~~and~~
 - (ii) ~~member and APSA attest that the APSA was performing the specific health maintenance tasks to the member's satisfaction on an informal basis as a friend or family member for a minimum of two (2) months in the period immediately prior to being hired as the PSA, and no evidence contra indicates the attestation of safe and competent performance by the APSA, additional documentation is not required.~~
- (L) The ~~CDA/CMCDPASS CM~~ monitors the member's well-being and the quality of supports and services and assists the member in revising the PSA services plan as needed. When the member's need for services changes due to a change in health/disability status and/or a change in the level of support available from other sources to meet needs, the

~~CDA/CM CD-PASS~~CDPASS CM, based upon an updated assessment, amends the person-centered service plan to modify ~~CD-PASS~~CDPASS service units ~~appropriate~~appropriately to meet the additional need and submits the plan amendment to the AA for authorization and update of the member's IBA.

(M) In the event of a disagreement between the member and ~~CD-PASS~~CDPASS provider the following process is followed:

(i) either party may contact via a ~~toll free~~toll-free number the ~~Member/Provider Relations Resource Center~~ to obtain assistance with issue resolution;

(ii) ~~when the issue cannot be resolved with assistance from the Member/Provider Relations Resource Center or from CD-PASS Program Management, the CD-PASS Program Management submits the dispute to the ADvantage Escalated Issues Unit for resolution. The Escalated Issues Unit works with the member and provider to reach a mutually agreed upon resolution;~~

~~(iii) when the dispute cannot be resolved by the ADvantage Escalated Issues Unit~~AA protocol, it is heard by the Ethics of Care Committee. The Ethics of Care Committee makes a final determination ~~with regard to settlement of the~~regarding dispute ~~settlement~~; or

~~(iv)~~(iii) at any step of this dispute resolution process the member may request a fair hearing to appeal the dispute resolution decision.

(N) The ~~CDA/CM~~CDPASS CM and the member prepare an emergency backup response capability for ~~CD-PASS~~CDPASS PSA/APSA services in the event a PSA/APSA services provider essential to the individual's health and welfare fails to deliver services. As part of the backup planning process, the ~~CDA/CM~~CDPASS CM and member define what failure of service or neglect of service tasks constitutes a risk to health and welfare to trigger implementation of the emergency backup when (i) or (ii) may be used. Identification of:

(i) a qualified substitute provider of PSA/APSA services and preparation for their quick response to provide backup emergency services, including execution of all qualifying background checks, training, and employment processes; and/or

(ii) one (1) or more qualified substitute ADvantage agency service providers, adult day health, personal care, or nursing facility (NF) respite provider, and preparation for quick response to provide backup emergency services.

(O) To obtain authorizations for providers other than PSA and APSA identified as emergency backups, ~~the CDPASS CM~~ requests the AA authorize and facilitate member access to adult day health, agency personal care, or NF respite services.

(5) The CDPASS case manager submits the person-centered service plan to the CDPASS case management supervisor for review. The CDPASS case management supervisor conducts the review/approval of the plans ~~within two business (2 business) days of receipt~~ from the CDPASS case manager or returns the plans to the CDPASS case manager with notations of errors, problems, and concerns to be addressed. The CDPASS case manager re-submits the corrected person-centered service plan to the CDPASS case management supervisor ~~within two business (2 business) days~~. The CDPASS case management supervisor returns the approved person-centered service plan to the CDPASS case manager. Within one-business (1-business) day of receiving supervisory approval, the case manager submits, the person-centered service plan to the AA. Only priority service needs and supporting documentation may be submitted to the AA as a "Priority" case with justification attached. "Priority" service needs are defined as services needing immediate authorization to protect the health and welfare of the member

and/or avoid premature admission to the NF. Corrections to service conditions set by the AA are not considered a priority unless the health and welfare of the member would otherwise be immediately jeopardized and/or the member would otherwise require premature admission to a NF.

(6) Within one-business (1-business) day of notification of care plan and person-centered service plan authorization, the CDPASS case manager communicates with the service plan providers and member to facilitate service plan implementation. Within ~~five-business (5-business)~~ seven-business (7-business) days of notification of an initial person-centered service plan or a new reassessment service plan authorization, the CDPASS case manager visits the member, gives the member a copy of the person-centered service plan and evaluates the service plan implementation progress. The CDPASS case manager evaluates service plan implementation on the following minimum schedule:

(A) within thirty-calendar (30-calendar) days of the authorized effective date of the person-centered service plan or service plan ~~addendum~~-amendment; and

(B) monthly after the initial thirty-calendar (30-calendar) days follow-up evaluation date.

(b) Authorization of service plans and amendments to service plans. The AA authorizes the individual person-centered service plan and all service plan amendments for each ADvantage member. When the AA verifies member ADvantage eligibility, service plan cost effectiveness for service providers that are ADvantage authorized and SoonerCare contracted, and that the delivery of ADvantage services are consistent with the member's level of care need, the service plan is authorized.

(1) Except as provided by the process per Oklahoma Administrative Code (OAC) 317:30-5-761~~(6)~~, family members may not receive payment for providing ADvantage waiver services. A family member is defined as an individual who is legally responsible for the member, such as the spouse or parent of a minor child or legal guardian.

(2) ~~DHS AS may, per OAC 317:35-15-13, authorize personal care service provision by an Individual PCA, an individual contracted directly with OHCA. Legally responsible family members are not eligible to serve as Individual PCAs.~~

~~(3)~~ When a complete service plan authorization or amendment request is received and the service plan is within cost-effectiveness guidelines, the AA authorizes or denies authorization within ~~five-business (5-business)~~ seven-business (7-business) days of receipt of the request. When the service plan is not within cost-effectiveness guidelines, the plan is referred for administrative review to develop an alternative cost-effective plan or assist the member to access services in an alternate setting or program. When the request packet is incomplete, the AA notifies the case manager immediately and puts a hold on authorization until the requirements are received from case management.

~~(4)~~(3) The AA authorizes the service plan by entering the authorization date. Notice of authorization of the service plan is available through the appropriate designated software or web-based solution. AA authorization determinations are provided to case management within one-business (1-business) day of the authorization date. A person-centered service plan may be authorized and implemented with specific services temporarily denied. The AA communicates to case management the conditions for approval of temporarily denied services. The case manager submits revisions for denied services to AA for approval within ~~five-business (5-business)~~ seven-business (7-business) days.

~~(5)~~(4) For audit purposes including Program Integrity reviews, the authorized service plan is documentation of service authorization for ADvantage waiver and State Plan Personal Care

services. Federal or State quality review and audit officials may obtain a copy of specific person-centered service plans with original signatures by submitting a request to the member's case manager.

(c) **Change in service plan.** The process for initiating a change in the person-centered service plan is described in this subsection.

(1) The service provider initiates the process for an increase or decrease in service to the member's person-centered service plan. The requested changes and justification are documented by the service provider and, when initiated by a direct care provider, are submitted to the member's case manager. When in agreement, the case manager submits the service changes within ~~five-business (5-business)~~seven-business (7-business) days of the assessed need. The AA authorizes or denies the person-centered service plan changes, per OAC 317:35-17-14.

(2) The member initiates the process for replacing personal care services with ~~CD-PASS in geographic areas where CD-PASS~~CDPASS services are available. The member may contact the AA ~~or call the toll-free number~~ to process requests for ~~CD-PASS~~CDPASS services.

(3) A significant change in the member's physical condition or caregiver support, one that requires additional goals, deletion of goals or goal changes, or requires a four-hour (4-hour) or more adjustment in services per week, requires an updated UCAT ~~Part III~~ reassessment by the case manager. The case manager develops and submits an amended or new person-centered service plan, as appropriate, ~~and submits the new amended person-centered service plan for~~ authorization.

(4) One (1) or more of the following changes or service requests require an Interdisciplinary Team review and service plan goals amendment:

- (A) the presence of two (2) or more ADvantage members residing in the same household;
- or
- (B) the member and personal care provider residing together; or
- (C) a request for a family member or legal representative to be a paid ADvantage service provider; ~~or~~
- ~~(D) a request for an individual PCA service provider.~~

(5) Based on the reassessment and consultation with the AA as needed, the member may, as appropriate, be authorized for a new person-centered service plan or be eligible for a different service program. When the member is significantly improved from the previous assessment and does not require ADvantage services, the case manager obtains the member's dated signature indicating voluntary withdrawal for ADvantage program services. When unable to obtain the member's consent for voluntary closure, the case manager requests AA assistance. The AA requests that the ~~DHS area~~OKDHS nurse initiate a reconsideration of level of care.

(6) Providers of Home and Community Based Services (HCBS) for the member, or those who have an interest in or are employed by a provider of HCBS for the member, must not provide case management or develop the person-centered service plan, except when the State demonstrates the only willing and qualified entity to provide case management and develop person-centered service plans in a geographic area also provides HCBS.

317:35-17-18. ADvantage services during hospitalization or NF placement

When the member's ~~DHS~~OKDHS social worker, ADvantage case manager, or the ~~AA~~ADvantage Administration (AA) is informed by the member, family, or service provider of a member's hospitalization or placement in a nursing facility (NF), that party determines the date of the member's institutionalization and communicates the date, name of the institution, reason for

placement, and expected duration for placement to the other ADvantage Program Administrative partners. When a member requires hospital or NF services, the case manager assists the member to access institutional care, periodically monitors the member's progress during the institutional stay, and, as appropriate, updates the person-centered service plan and prepares services to start on the date the member is discharged from the institution and returns home. All case management units for institution transition services to plan for and coordinate service delivery and to assist the member to safely return home, even when provided while the person is in an institution, are considered delivered on and billed for the date the member returns home from institutional care.

(1) **Hospital discharge.** When the member returns home from a hospital or when notified of the member's anticipated discharge date, the case manager notifies relevant providers and the ~~ADvantage Administration (AA), AA~~ and coordinates the resumption of services.

(2) **Nursing Facility placement of less than 30-calendar days.** When the member returns home from a NF stay of 30-calendar days or less or when notified of the member's anticipated discharge date, the case manager notifies relevant providers, the member's ~~DHS~~OKDHS worker and the AA of the discharge and coordinates the resumption of ADvantage services in the home.

(3) **Nursing Facility placement longer than 30-calendar days.** When the member is scheduled to be discharged and return home from a NF stay that is longer than 30-calendar days, the member's ~~DHS~~OKDHS worker, ADvantage case manager, or the AA, whoever first receives notification of the discharge, notifies other ADvantage Program Administrative partners to expedite the restart of ADvantage services for the member. The member's case manager provides institution transition case management services to assist the member to re-establish ~~him~~himself or herself safely in the home. Individuals residing in a NF may be referred to OHCA Living Choice for assistance transitioning to the community, as needed.

317:35-17-19. Closure or termination of ADvantage services

(a) **Voluntary closure of ADvantage services.** When the member requests a lower level of care than ADvantage services; or agrees that ADvantage services are no longer needed to meet his or her needs, a medical level of care decision by the area nurse or nurse designee, is not needed. The closure request is completed and signed by the member and the ADvantage case manager and sent to the ADvantage Administration (AA) ~~to be placed in the member's case record~~ for processing in the electronic system. ~~The AA notifies the Oklahoma Department of Human Services (DHS) area nurse or area nurse designee of the voluntary closure and effective date of closure.~~ When the member's written request for closure cannot be secured, ~~the ADvantage case manager documents in the member's case record~~ the reasons for the voluntary termination of services and alternatives for services are documented in the electronic system.

(b) **Closure due to financial or medical ineligibility.** The process for closure due to financial or medical ineligibility is described in this subsection.

(1) **Financial ineligibility.** When the local ~~DHS~~Oklahoma Human Services (OKDHS) office determines a member does not meet financial eligibility criteria, the DHS office notifies the area nurse or area nurse designee who closes the member's authorization and notifies the member and AA of financial ineligibility by system-generated mail. The AA notifies the member's providers of the decision. A medical eligibility redetermination is not required when a financial ineligibility period does not exceed the medical certification period.

(2) **Medical ineligibility.** When the ~~DHS~~OKDHS office is notified by the ~~area~~ nurse or ~~area~~ nurse designee of a decision that the member is no longer medically eligible for ADvantage services, the ~~DHS~~OKDHS office notifies the member and AA of the decision. Refer to

Oklahoma Administrative Code (OAC) 317:35-17-16 (d). The AA notifies the member's providers of the decision.

(c) **Closure due to other reasons.** Refer to OAC 317:35-17-3(e) - (h).

~~(d) **Resumption of ADvantage services.** When a member approved for ADvantage services is without services for less than ninety (90) calendar days and has a current medical and financial eligibility determination, services may be resumed using the previous authorized person-centered service plan. When a member requests to have his or her services restarted after ninety (90) calendar days, the member must request a new referral for services through the DHS county office or AA. When a member is determined eligible for ADvantage services and transitions from a hospital or a nursing facility to a community setting, an ADvantage case manager may provide Institution Transition case management services to assist the member to establish or re-establish him or herself safely in the home.~~

317:35-17-21.1. ADvantage and agency Personal Care provider certification

ADvantage Administration (AA) ~~forwards~~provides real-time information on all certified ADvantage and Personal Care agency providers providing services in ~~the specific OKDHS areacounties to the area nurse and OKDHS county director~~through the Certified Agencies Report (CAR) located in the electronic database. The provider information includes agency name, address, contact person ~~for ADvantage/Personal Care programs,~~ provider number, a list of ~~ADvantage/Personal Care~~ADvantage services the provider is certified to deliver, and other information as needed by OKDHS staff to achieve efficient service delivery. The AA certifies ADvantage case managers and case management supervisors. The AA maintains a master registry of certified ADvantage case management supervisors and case managers. Case manager certifications are based on successful completion of ADvantage case management training and demonstration of competency in case management and, for supervisors, case management supervision. ~~As~~The CAR is updated as additional providers are certified in an OKDHS ~~areacounty~~ or if a provider loses certification, AA ~~provides appropriate notice to the area nurse and OKDHS county director in counties affected by the certification changes.~~ The ~~OHCA~~Oklahoma Health Care Authority (OHCA) may execute agreements to provide care only with qualified individuals and agencies and facilities which are properly licensed or certified by the state licensing or certification agency and, as applicable, Title XIX certified. The agreement is initiated by application from the individual agency or facility. The agreement expires on a specified date, with termination of the agency license or certification, or automatically terminated on notice, with appropriate documentation, to OHCA that the individual agency or facility is not in compliance with Title XIX (or other federal long-term care) requirements. The AA certifies Title XIX providers of ADvantage services with the exception of pharmacy and medical equipment and supply providers.

317:35-17-26. Ethics of Care Committee

(a) The ADvantage Program Ethics of Care Committee (EOCC) reviews ~~members~~members' cases when the ADvantage, State Plan Personal Care programs or a provider contracted to provide these services determines that a member's identified needs cannot be met through the provision of the ADvantage program or State Plan Personal Care program and other formal or informal services are not in place or immediately available to meet the members health and safety needs. The EOCC is a core group of designated representatives from Oklahoma ~~Department of Human Services~~ (~~DHS~~OKDHS) Community Living, Aging and Protective Services and Oklahoma Health Care

Authority staff and are experts in State Medicaid programs, specifically ADvantage waiver and State Plan Personal Care, and experienced in addressing member issues ~~as it pertains~~pertaining to policy, program, and service delivery.

(b) EOCC decisions are predicated upon four (4) guiding principles.

(1) **Sustainability of member services.** The overarching concern of EOCC is to ensure ~~that~~ all efforts are made to sustain the member's services when possible. EOCC explores options and renders a decision that maintains member safety while averting the primary issue of concern before the EOCC. This is done while assuring member health and safety as outlined in Oklahoma Administrative Code (OAC) 317:35-17-3-~~(h)~~ (1-7).

(2) **Cultural competence.** EOCC considers the contextual details of the situation to promote needs and interests of ADvantage members and emphasizes understanding of the members culture and relevant circumstances.

(3) **Balance and reciprocity.** This assures member health and safety is reliant upon the member's cooperation and that of the member's community network, or informal supports. EOCC evaluates the viability of the member's resources to sustain health and safety independent of Medicaid paid supports when making decisions.

(4) **Education and mitigation.** EOCC uses decision-making processes for determining program appropriateness for cases that are problematic or controversial with respect to being able to meet member needs within program constraints. The decision-making process engages expertise from any area of program function relevant to the case in question, when necessary. When the case submitted for review is deemed invalid or lacking sufficient merit for review, EOCC rescinds the review until the case meets the appropriate criteria for review.

(c) EOCC reviews ADvantage and State Plan Personal Care cases, including but not limited to, when:

(1) the member can no longer safely remain in the community;

(2) the member shows a consistent pattern of non-compliance and non-cooperativeness that prevents delivery of the authorized person-centered service plan or care plan;

(3) the provider's and/or ~~DHS~~SOKDHS staff's safety cannot be assured due to the actions of the member, ~~visit~~visitor, or another household member;

(4) the services required to meet member needs are beyond the scope of defined waiver or State Plan Personal Care services;

(5) the new ADvantage or State Plan Personal Care members meet financial and medical eligibility for the program, but require review for program appropriateness or community potential;

(6) the previous dis-enrolled ADvantage or State Plan Personal Care members ~~that~~ request re-enrollment into the ADvantage or State Plan Personal Care programs;

(7) the member scheduled for an administrative hearing in which the hearing officer requests EOCC review and input;

(8) members are under investigation or review by a federal authority; or

(9) all cases in which administrative review and input are warranted.

(d) ADvantage Consumer Directed Personal Assistance Service and Supports (~~CD-PASS~~CDPASS) service option cases are reviewed ~~for~~when the:

(1) circumstances under review are not addressed by ~~CD-PASS~~CDPASS requirements for member eligibility;

(2) a case scenario is not otherwise covered by an established process;

- (3) established processes of the ~~CD-PASS~~CDPASS program do not allow for an adequate resolution to the issues; or
- (4) ~~CD-PASS~~CDPASS eligibility impacts ADvantage eligibility, such as:
- (A) eligibility is removed but that action may place the member at a greater risk; or
 - (B) a member ~~and/or~~ their legal agent are removed from ~~CD-PASS~~CDPASS services due to allegations of fraudulent or illegal actions that may result in the member's loss of ADvantage eligibility.
- (e) EOCC review processes include: (1) through (11).
- (1) ~~The ADvantage Administration (AA)~~AA Member Relations Program Assistant Administrator ~~for Member/Provider Relations department~~ chairs the EOCC. He or she is responsible to appoint qualified representatives to the EOCC ~~committee~~;
 - (2) ~~committee~~Committee members, case representatives, ~~or~~ and presenters are required to adhere to Health Insurance Portability and Accountability Act and ~~DHS~~OKDHS confidentiality standards and be discreet when reviewing and discussing cases under consideration of all records and information disclosed in carrying out the duties and activities of the committee;
 - (3) ~~all~~All cases ~~that meet~~meeting the defined criteria for EOCC review are submitted to AA ~~Member/Provider~~Member Relations or Escalated Issues teams for processing and presentation;
 - (4) ~~the~~The Escalated Issues team formally requests a meeting for EOCC case review and ~~develop~~develops a meeting agenda and ~~provide~~provides EOCC members with relevant supporting documentation ~~or~~ for EOCC review prior to the scheduled meeting;
 - (5) ~~a~~A quorum (half plus one committee member) is present to make a decision or recommendation on any case presented to the EOCC;
 - (6) ~~designees~~Designees are not substituted for EOCC members;
 - (7) ~~the~~The EOCC Chair is notified in advance when it becomes necessary for other parties to be invited due to their expertise on the subject matter;
 - (8) ~~case~~Case presenters are dismissed after their presentations are complete, and the EOCC proceeds to mitigate the case;
 - (9) ~~upon~~Upon completion of the committee discussion, the EOCC Chair calls for a vote. A majority vote carries the motion. When a tie ensues, the Escalated Issues team Program Manager casts the deciding vote;
 - (10) ~~a~~A member determined by EOCC to be ineligible for ADvantage or ~~Medicaid~~ State Plan Personal Care program services is notified in writing by ~~DHS~~OKDHS of the determination and of his or her right to appeal the decision; and
 - (11) EOCC maintains all meeting minutes, decisions, court hearings, and files generated by our Escalated Issues department pertaining to the member indefinitely.

SUBCHAPTER 19. NURSING FACILITY SERVICES

317:35-19-2. Nursing Facility (NF) program medical eligibility determination

The Oklahoma ~~Department of~~ Human Services (~~DHS~~)(OKDHS) area nurse or nurse designee, determines medical eligibility for NF services based on the ~~DHS~~OKDHS nurse's Uniform Comprehensive Assessment Tool (UCAT) ~~Part III~~ assessment of the client's needed level of care, the outcome of the Level II Preadmission Screening and Resident Review (PASRR), when completed, and his or her professional judgment. The Oklahoma Health Care Authority (OHCA) Level of Care Evaluation Unit (LOCEU) makes some determinations when the PASRR is involved. Refer to Oklahoma Administrative Code (OAC) 317:35-19-7.1(3) for NF level of care medical eligibility

requirements.

- (1) When NF care services are requested prior to admission, the same rules related to medical eligibility determination identified in OAC 317:35-17-5 for ADvantage services are followed.
- (2) The ~~DHSOKDHS~~ nurse reviews the PASRR Level I in the OHCA system; completes the UCAT-III; and enters the date OHCA received the PASRR Level I (LTC-300R) from the NF and admission date to the NF; medical eligibility effective date and notes any Level II PASRR results if available in the UCAT-Part-III. This information is submitted to the ~~DHSOKDHS~~ area nurse for medical eligibility determination.
- (3) PASRR requirements are identified in OAC 317:35-19-8 and 317:35-19-9.
- (4) When it is not possible ~~for to complete~~ the UCAT Part-III assessment ~~to be completed~~ prior to admission, the NF is responsible for notifying the ~~DHSOKDHS~~ of the admission. Notification is mailed or faxed on ~~DHSOKDHS~~ Form 08MA083E, Notification Regarding Patient In A Nursing Facility, Intermediate Care Facility for the Intellectually Disabled or Hospice, and Management Recipient Funds to the local ~~DHSOKDHS~~ county office. Upon receipt, the ~~DHSOKDHS~~ county office processes Forms 08MA083E and 08MA084E and completes and forwards the Form 08MA038E, Notice Regarding Financial Eligibility to the NF. Identified sections of the UCAT-Part-III reflecting the domains for meeting medical criteria are completed for applicants residing in the NF at the time of assessment. The area nurse or nurse designee, confirms the date of medical eligibility and records it in the system. The facility is responsible for performing the PASRR Level I screen and consulting with OHCA staff to determine when a need exists for a Level II screen. The ~~DHSOKDHS~~ nurse completes the assessment within fifteen-business (15-business) days of PASRR clearance when the individual's needs are included in an active ~~DHSOKDHS~~ coded case. When the individual's needs are not included in an active case, the assessment is completed within twenty-business (20-business) days of PASRR clearance.
- (5) The area nurse or nurse designee, evaluates the PASRR Level I screen and the UCAT ~~Part III~~ in consultation with the ~~DHSOKDHS~~ nurse when the completed LTC-300R and/or facility documentation shows a need exists for a possible Level II screen. The area nurse or nurse designee consults with OHCA staff as necessary.
- (6) The area nurse or nurse designee, evaluates the UCAT ~~Parts I and III~~, to determine if the applicant meets the medical eligibility criteria for NF level of care. Individuals may be medically-certified for NF level of care for various lengths of time depending on the client's needs. The area nurse or nurse designee, enters the medical eligibility decision and, when required, the medical certification review date into ~~Aging Services Division Electronic Data Entry and Retrieval System (ELDERS)~~ the electronic system within ten-business (10-business) days. A medical eligibility redetermination is not required when a client is discharged from the NF for a period not to exceed ninety-calendar (90-calendar) days and the original certification is current.
- (7) When the ~~DHSOKDHS~~ nurse recommends NF level of care and the client is determined by the area nurse or nurse designee, not to be medically eligible for NF level of care, the ~~DHSOKDHS~~ nurse can submit additional information to the area nurse or nurse designee. When necessary, a visit by the ~~DHSOKDHS~~ nurse to obtain additional information is initiated at the recommendation of the area nurse or nurse designee.
- (8) Categorical relationship must be established for determination of eligibility for NF services. When categorical relationship to disability has not been established, the worker submits the same information, per OAC 317:35-5-4(2), to the LOCEU to request a determination of

eligibility for categorical relationship. LOCEU renders a decision on categorical relationship to the disabled applicant using the Social Security Administration (SSA) definition. A follow-up with the SSA by the ~~DHS~~OKDHS worker is required to ensure the SSA disability decision agrees with the LOCEU decision.

317:35-19-18. Change in level of long-term medical care

(a) When a member is receiving Personal Care services and requests nursing facility care ~~or when a member is in a nursing facility and requests Personal Care services~~, a new Uniform Comprehensive Assessment Tool (UCAT) is required. ~~The UCAT is updated if the member is in the nursing facility and requests ADvantage waiver services. No new medical decision is needed. Also, no~~ No new medical decision is needed for admission to a nursing facility from home if the period of absence from the nursing facility is less than 90 days. No new medical decision is needed if the member loses financial eligibility but maintains medical eligibility by having a current medical decision and by remaining in the facility during the period of financial ineligibility.

(b) When there is a decision that a member approved for one level of long-term care is eligible for a different level of care, the local office is advised by update of the file. ~~If the change is from facility care to Personal Care, a new UCAT, Part III care plan, service plan, and other required forms are submitted to the area nurse, or nurse designee. If the Personal Care member requests a decision regarding facility care prior to admission to a facility, the LTC nurse is responsible for submitting the UCAT, Part III, and Form LTC-300R to the area nurse, or nurse designee for a decision.~~

(c) When the area nurse, ~~or nurse designee~~, determines that a new nursing care facility member ~~no longer needs~~ does not meet this level of care, payment may be continued while the member, or other responsible person, makes other arrangements. The length of such continuation of payment depends upon the circumstances, but must allow time for the appropriate advance notice to the member and cannot exceed 60 days from the date of the decision.

**TITLE 317. OKLAHOMA HEALTH CARE AUTHORITY
CHAPTER 30. MEDICAL PROVIDERS-FEE FOR SERVICE**

SUBCHAPTER 5. INDIVIDUAL PROVIDERS AND SPECIALTIES

PART 5. PHARMACIES

317:30-5-87. 340B Drug Discount Program

(a) The 340B Drug Discount Program is a drug-pricing program established under section 256b of Title 42 of the United States Code (U.S.C) under which a manufacturer of covered outpatient drugs agrees that it will not charge a 340B covered entity more than the 340B price for a 340B covered outpatient drug.

(b) Covered entities participating in the 340B Drug Discount Program will adhere to the following provisions outlined in this Section and as defined in 42 U.S.C. § 256b. Covered entities must:

(1) Notify the OHCA Pharmacy Department in writing within thirty (30) days of any changes in 340B Program participation, as well as any changes in name, address, National Provider Identification (NPI), SoonerCare Provider Number, etc.

(2) Maintain their status on the Health Resources & Services Administration (HRSA) Medicaid Exclusion File (MEF) and report any changes to the OHCA within thirty (30) days.

(3) Execute a contract addendum with the OHCA in addition to their provider contract.

(c) To prevent a duplicate discount, quarterly adjustments will be made to all pharmacy or medical claims for drugs submitted by covered entities when billed using the registered SoonerCare Provider Number on the MEF.

(1) All pharmacy claims submitted by covered entities shall be adjusted by the 340B ceiling price whether purchased through the 340B Program or otherwise.

(2) Medical claims submitted by covered entities with procedure code modifiers indicating the use of the 340B purchased drugs shall be adjusted by the 340B ceiling price. OHCA will adjust each claim by subtracting the 340B ceiling price from the amount reimbursed and multiplying the difference by the quantity submitted. OHCA will use the 340B ceiling price applicable to the quarter in which the claim is paid. Medical claims submitted by covered entities with a procedure code modifier indicating the use of non 340B purchased drugs will not be adjusted by the 340B ceiling price and will be submitted for federal rebates as required by CMS. Covered entities are required to use an appropriate procedure code modifier on all physician administered drug lines when submitting medical claims.

(3) If a 340B covered entity fails to pay quarterly adjustments invoiced by OHCA within forty-five (45) days of receipt, it may result in a debt to the State of Oklahoma subject to applicable interest pursuant to prompt payment methodology at OAC 260:10-3-3.

(4) The quarterly adjustments invoiced, including applicable interest, must be paid regardless of any disputes made by the covered entity. If a covered entity fails to pay OHCA the adjustments invoiced within forty-five (45) days of receipt, the adjustments invoiced and applicable interest will be deducted from the facility's payment.

(d) Contract pharmacies for covered entities may be permitted to bill drug products purchased under the 340B Drug Discount Program to the Oklahoma Medicaid Program when certain conditions are met and an agreement is in place between the OHCA, the contract pharmacy, and the covered entity. These pharmacies will be subject to the recovery process stated in this Section.

This page intentionally left blank

**TITLE 317. OKLAHOMA HEALTH CARE AUTHORITY
CHAPTER 30. MEDICAL PROVIDERS-FEE FOR SERVICE**

SUBCHAPTER 5. INDIVIDUAL PROVIDERS AND SPECIALTIES

PART 43. AGENCY COMPANION, SPECIALIZED FOSTER CARE, DAILY LIVING SUPPORTS, GROUP HOMES, AND COMMUNITY TRANSITION SERVICES

317:30-5-423. Coverage limitations

- (a) Coverage limitations for residential supports for members with an intellectual disability are:
- (1) Description: agency companion services (ACS); Unit: one day; Limitation: 366 units per year;
 - (2) Description: specialized foster care (SFC); Unit: one day; Limitation: 366 units per year;
 - (3) Description: daily living supports (DLS); Unit: one day; Limitation: 366 units per year; and
 - (4) Description: group home services; Unit: one day; Limitation: 366 units per year.
- (b) Members may not receive ACS, SFC, DLS and group home services at the same time.
- (c) Community transition services (CTS) are limited to ~~\$2,400~~\$3,000 per eligible member.
- (1) CTS is limited to one transition over the member's lifetime. If the member's situation changes after receipt of CTS and hospitalization or readmission to an intermediate care facility for the mentally retarded (ICF/MR) is necessary, CTS is not authorized upon transition back into the community.
 - (2) Members moving into a group home, SFC, or ACS arrangement in the companion's home are not eligible to receive CTS.

This page intentionally left blank

**TITLE 317. OKLAHOMA HEALTH CARE AUTHORITY
CHAPTER 40. DEVELOPMENTAL DISABILITIES SERVICES**

SUBCHAPTER 5. MEMBER SERVICES

PART 9. SERVICE PROVISIONS

317:40-5-101. Architectural modifications (AM)

(a) **Applicability.** The rules in this Section apply to ~~architectural modification (AM)~~ services authorized by ~~the Oklahoma Department of Human Services (OKDHS) Developmental Disabilities Services Division (DDSD)~~ through Home and Community Based Services (HCBS) Waivers.

(b) **General information.** Architectural Modification services:

- (1) are provided by building contractors who have contractual agreements with the Oklahoma Health Care Authority to provide Home and community Based Services. Providers must meet requirements of the International Code Council (ICC), formerly the Building Official and Code Administrators (BOCA), for building, electrical, plumbing and mechanical inspections;
- (2) include the installation of ramps, grab-bars, widening of doorways, modification of a bathroom or kitchen facilities, specialized safety adaptations such as scald protection devices, stove guards, and modifications required for the installation of specialized equipment, which are necessary to ensure the health, welfare and safety of the member or that enable the member to function with greater independence in the home;
- (3) must be recommended by the member's Team and included in the member's IP. Arrangements for this service must be made through the member's case manager;
- (4) are performed on homes of eligible members who have disabilities that limit accessibility or require modifications to ensure health and safety;
- (5) are provided based on the:
 - (A) assessment and Personal Support Team (Team) consideration of the member's unique needs per OAC 317:40-5-101(b);
 - (B) scope of architectural modifications per OAC 317:40-5-101;
 - (C) most appropriate and cost effective bid, if applicable, ensuring the quality of materials and workmanship;
 - (D) lack of a less expensive equivalent, such as assistive technology, that meets the member's needs; and
 - (E) safety and suitability of the home.
- (6) are limited to modifications of two different residences within any seven-year period beginning with the member's first request for an approved architectural modification service;
- (7) are provided with assurance of plans for the member to remain in the residence for at least five years;
- (8) may be denied when ~~DDSD~~ determines the home is unsafe or otherwise unsuitable for architectural modifications.
 - (A) ~~DDSD area office~~ resource development staff with architectural modification experience screens a home for safety and suitability for architectural modifications prior to home acquisition.
 - (B) Members needing home modification services and provider agencies assisting members to locate rental property identify several homes, when possible, for screening

- in order to select a home with the fewest or most cost effective modifications;
- (9) are provided to eligible members with the homeowner's signed permission;
 - (10) are not authorized to modify homes solely for family or staff convenience or for cosmetic preference;
 - (11) are provided on finished rooms complete with wiring and plumbing;
 - (12) services that do not meet the requirements of OAC 317:40-5-101 may be approved by the DDS~~D~~ division administrator or designee in exceptional circumstances; and
 - (13) are authorized in accordance with requirements of The Oklahoma Central Purchasing Act 74 O.S., § 85.1 et. Seq., Chapter 15 of Title 580 of the Department of Central Services, and other applicable statutory provisions.

(c) Assessment and Team process.

- (1) Architectural modification assessments are performed by:
 - (A) ~~DDS~~D~~ area office~~ resource development staff with architectural modification experience, when the requested architectural modification complies with minimum applicable national standards for persons with physical disabilities as applicable to private homes; or
 - (B) a licensed occupational therapist or physical therapist, at the request of designated ~~DDS~~D~~ area office~~ resource development staff ~~or area program supervisory staff~~, when the requested architectural modification exceeds or requires a variance to applicable national standards for persons with physical disabilities, or when such expertise is deemed necessary by ~~DDS~~D~~ area office~~ resource development staff ~~or area program supervisory staff~~.
- (2) The Team considers the most appropriate architectural modifications based on the:
 - (A) member's needs;
 - (B) member's ability to access his or her environment; and
 - (C) possible use of assistive technology instead of architectural modification.
- (3) The Team considers architectural modifications that:
 - (A) are necessary to ensure the health, welfare, and safety of the member; and
 - (B) provide the member increased access to the home to reduce dependence on others for assistance in daily living activities.

(d) Requirements and standards for architectural modification contractors and construction.

All contractors must meet applicable federal, state and local requirements.

- (1) Contractors are responsible for:
 - (A) obtaining all permits required by the municipality where construction is performed;
 - (B) following all applicable building codes; and
 - (C) taking and providing pictures to ~~area office~~ resource development staff of each completed architectural modification project within five working days of project completion and prior to payment of the architectural modification claim. ~~Area office resource~~ Resource development staff may take pictures of the completed architectural modification projects when requested by the contractor.
- (2) Any penalties assessed for failure to comply with requirements of the municipality are the sole responsibility of the contractor.
- (3) New contractors must provide three references of previous work completed.
- (4) Contractors must provide evidence of:
 - (A) liability insurance;
 - (B) vehicle insurance;

- (C) worker's compensation insurance or affidavit of exemption; and
- (D) lead paint safety certificate.
- (5) All modifications meet national standards for persons with physical disabilities as applicable to private homes unless a variance is required by the assessment.
- (6) Contractors complete construction in compliance with written assessment recommendations from the:
 - (A) ~~DDSD area office~~ resource development staff with architectural modification experience; or
 - (B) a licensed professional.
- (7) All architectural modifications must be completed by using high standard materials and workmanship, in accordance with industry standard.
- (8) Ramps are constructed using the standards in (A) through (G) of this paragraph.
 - (A) ~~All exterior wooden ramps are constructed of number two pressure treated wood.~~
 - ~~(B)~~ Surface of the ramp has a rough, non-skid texture.
 - ~~(C)~~ Ramps are assembled by the use of deck screws.
 - ~~(D)~~ Hand rails on ramps, if required, are sanded and smooth.
 - ~~(E)~~(B) Ramps ~~can~~must be constructed of ~~stamped aluminum~~ or steel.
 - ~~(F)~~(C) Support legs on ramps are no more than six feet apart.
 - ~~(G)~~ ~~Posts on ramps must be set or anchored in concrete.~~
- (9) Roll-in showers are constructed to meet standards in (A) through (E) of this paragraph.
 - (A) The roll-in shower includes a new floor that slopes uniformly to the drain at not less than one-fourth nor more than one-half inch per foot.
 - (B) The material around the drain is flush, without an edge on which water can catch before going into the drain.
 - (C) Duro-rock, rather than sheet rock, is installed around the shower area, at least 24 inches up from the floor, with green board above the duro-rock.
 - (D) Tile, shower insert, or other appropriate water resistant material is installed to cover the duro-rock and green board.
 - (E) The roll-in shower includes a shower pan, or liner if applicable.
 - (F) Roll in showers may also be constructed with a one piece pre-formed material.
- (10) ~~DDSD area office~~ resource development staff inspect any or all architectural modification work, prior to payment of an architectural modifications claim, to ensure:
 - (A) architectural modifications are completed in accordance with assessments; and
 - (B) quality of workmanship and materials used comply with requirements of OAC 317:40-5-101.
- (e) Architectural modifications when members change residences.**
 - (1) When two or more members share a home that has been modified and the member will no longer be sharing the home, the member whose Plan of Care authorized the modifications is given the first option of remaining in the residence.
 - (2) Restoration of architectural modifications is performed only for members of the Homeward Bound class when a written agreement between the homeowner and ~~DDSD~~ director, negotiated before any architectural modifications begin, describes in full the extent of the restoration. If no written agreement exists between the ~~DDSD~~ director and homeowner, OKDHS is not responsible to provide, pay for, or authorize any restorative services.
- (f) Services not covered under architectural modifications.** Architectural modifications do not include adaptations or improvements to the home which are of general utility and are not of direct

medical or remedial benefit to the member, construction, reconstruction, or remodeling of any existing construction in the home, such as floors, sub-floors, foundation work, roof, or major plumbing.

- (1) Square footage is not added to the home as part of an architectural modification.
- (2) Architectural modifications are not performed during construction or remodeling of a home.
- (3) Modifications not authorized by the OKDHS include, but are not limited to:
 - (A) roofs;
 - (B) installation of heating or air conditioning units;
 - (C) humidifiers;
 - (D) water softener units;
 - (E) fences;
 - (F) sun rooms;
 - (G) porches;
 - (H) decks;
 - (I) canopies;
 - (J) covered walkways;
 - (K) driveways;
 - (L) sewer lateral lines or septic tanks;
 - (M) foundation work;
 - (N) room additions;
 - (O) carports;
 - (P) concrete for any type of ramp, deck, or surface other than a five by five landing pad at the end of a ramp, as described in applicable national standards for persons with physical disabilities as applicable to private homes;
 - (Q) non-adapted home appliances;
 - (R) carpet or floor covering that is not part of an approved architectural modification that requires and includes a portion of the floor to be re-covered such as a roll in shower, a door widening; or
 - (S) a second ramp or roll in shower in a home.
- (4) A sidewalk is not authorized unless needed by the member to move between the house and vehicle.

(g) Approval or denial of architectural modification services. DDS approval or denial of an architectural modification service is determined in accordance with (1) through (3) of this subsection.

- (1) The architectural modification request provided by the DDS case manager to DDS area office resource development staff includes:
 - (A) documentation from the member's Team confirming the need and basis for architectural modification, including the architectural modification assessment;
 - (B) documentation of current Team consensus, including consideration of issues per OAC 317:40-5-101;
 - (C) lease, proof of home ownership, or other evidence that the member is able to live in the modified residence for at least 12 months; and
 - (D) an assurance by the member or legal guardian, if applicable, that the member plans to reside in the residence for five years.
- (2) The DDS area office:

~~(A) authorizes architectural modification services less than \$2500 when the plan of care is less than the state office reviewer limit; and~~

~~(B) provides all required information to the DDS State Office architectural modification programs manager for authorization of services when the plan of care is more than the area office limit or is \$2500 or more.~~

(3) Architectural modifications may be denied when the requirements of OAC 317:40-5-101 are not met.

(h) **Appeals.** The denial of acquisition of an architectural modification request may be appealed per OAC 340:2-5.

(i) **Resolving problems with services.** If the member, family member, or legal guardian, or Team is dissatisfied with the architectural modification, the problem resolution process per OAC 340:100-3-27 is initiated.

DRAFT

This page intentionally left blank



OPERATIONAL METRICS

January 2024 Board Meeting

Enrollment & Utilization

Total Enrolled Members

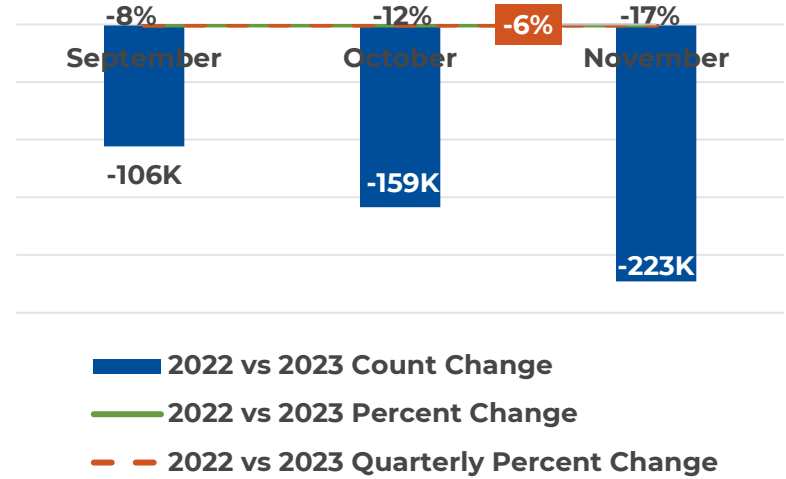
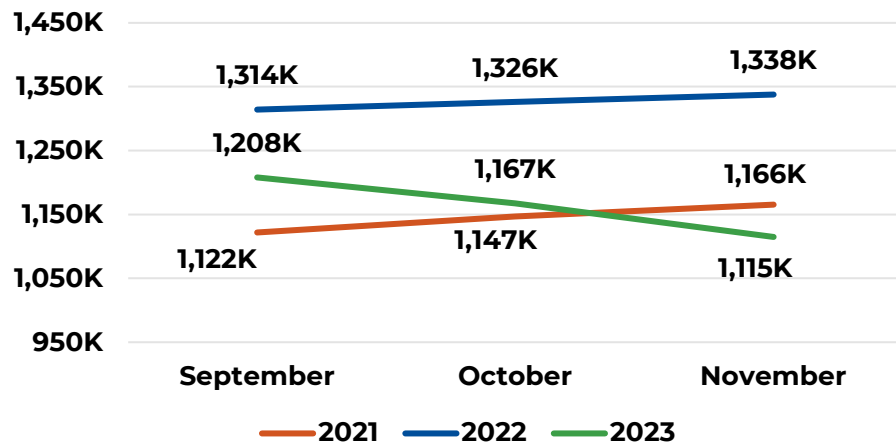

Aged/Blind/Disabled Enrolled

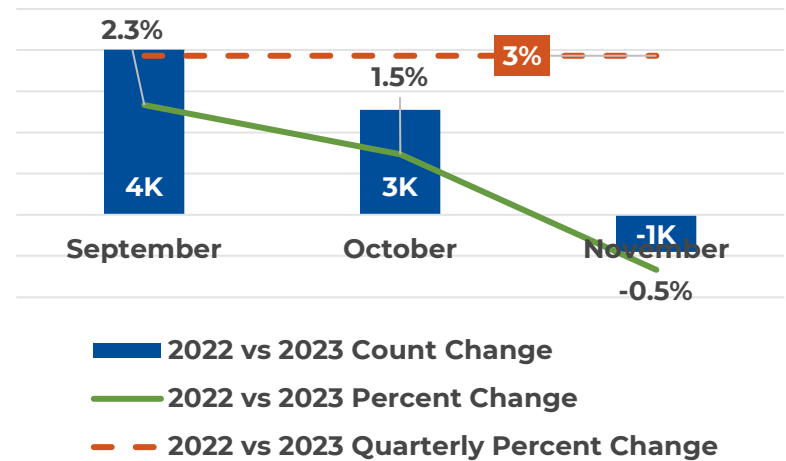
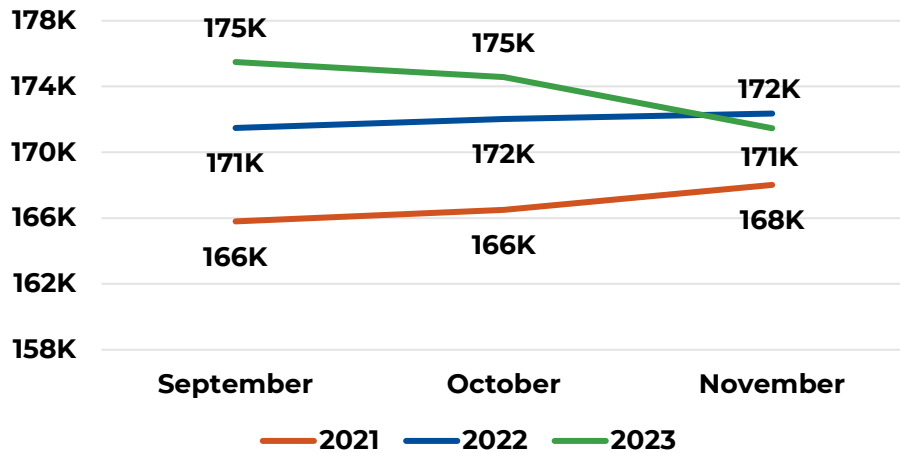

Enrollment & Utilization (Cont.)

Children & Parent/Caretaker Enrolled

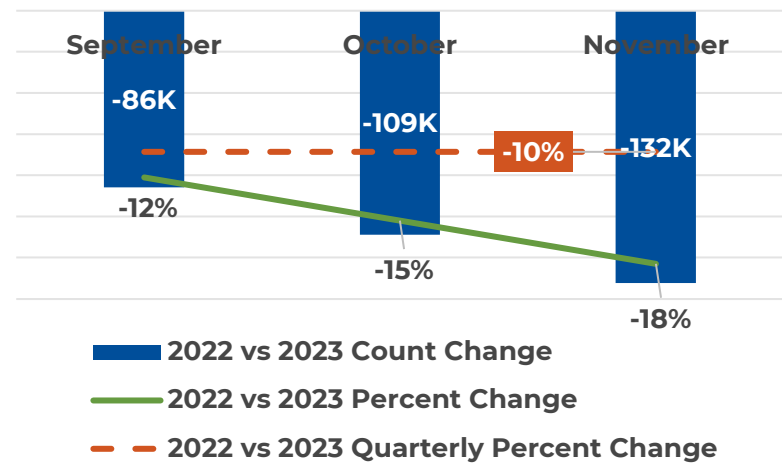
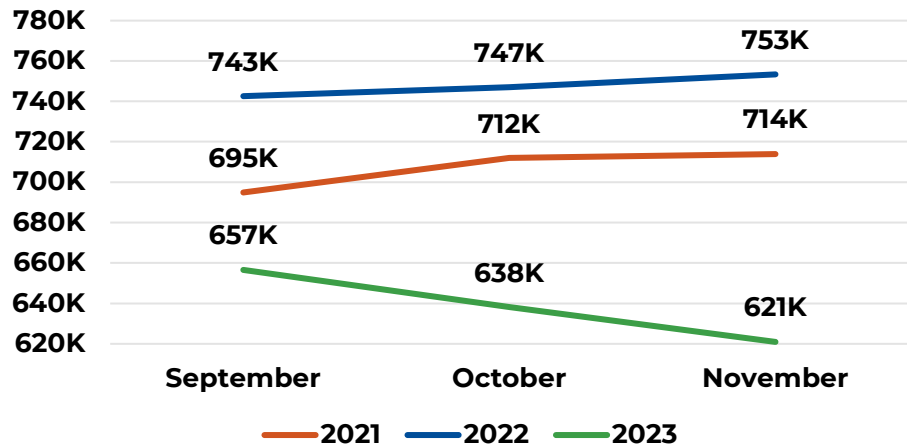

Pregnant (Full Scope) Enrolled

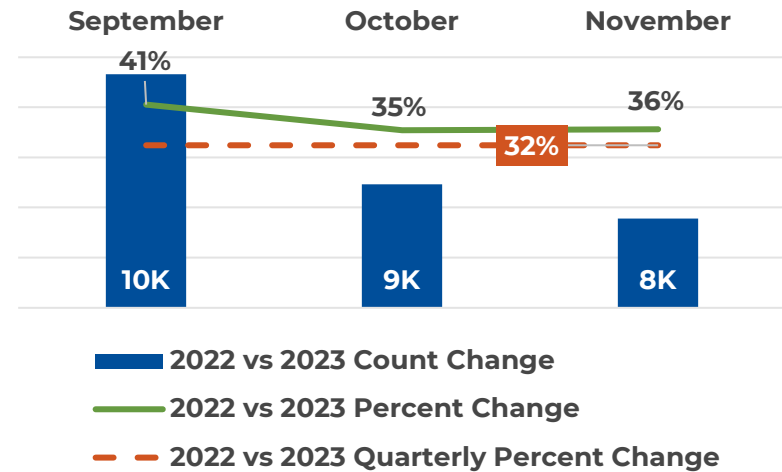
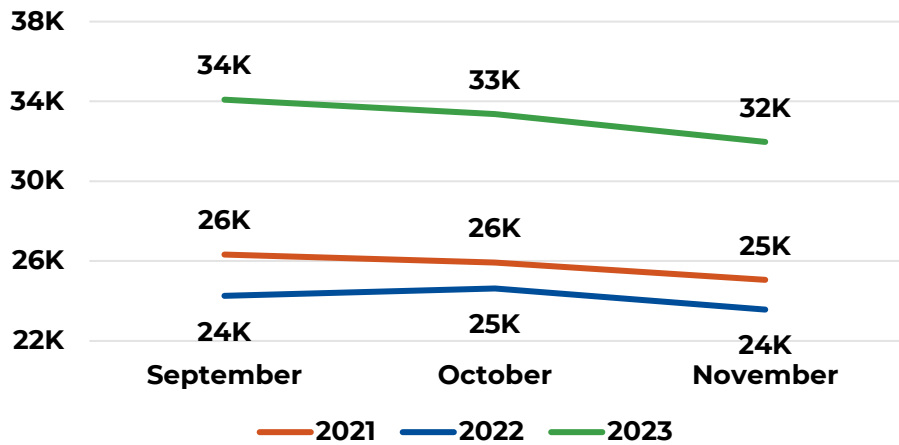

Enrollment & Utilization (Cont.)

Expansion Enrolled (Effective July 2021)

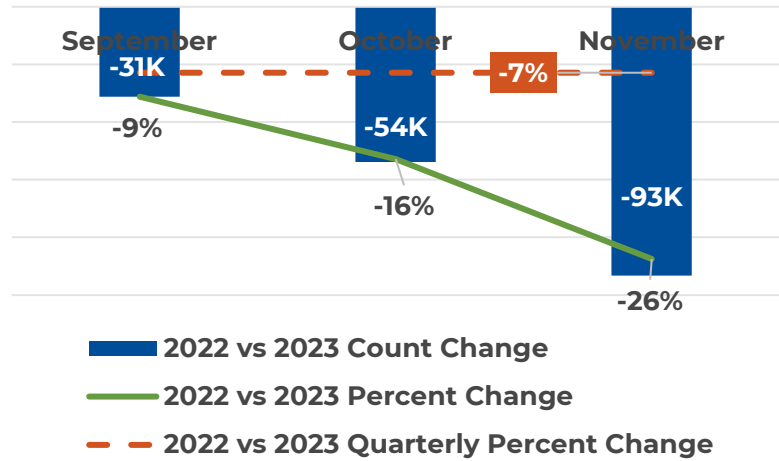
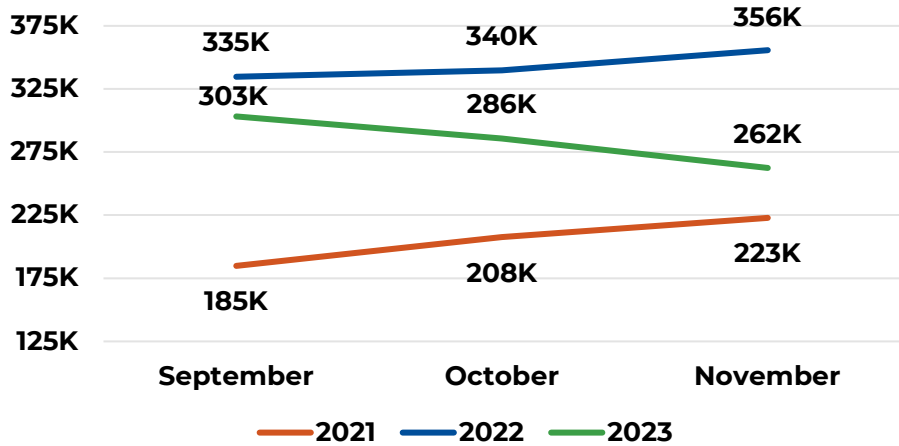

Percent of OK Population Enrolled

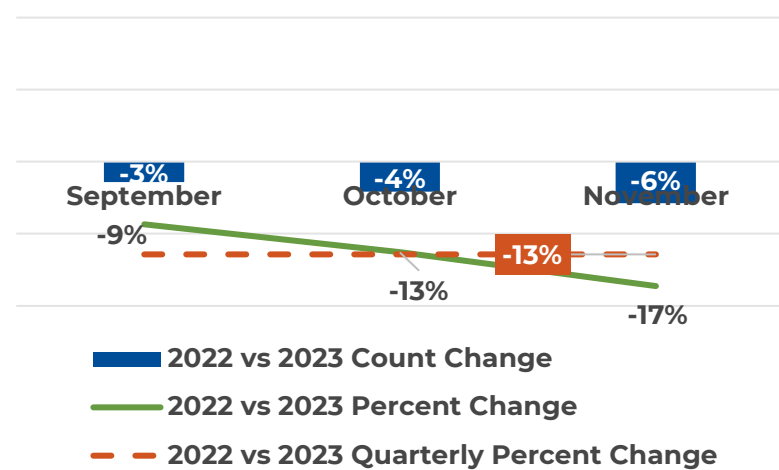
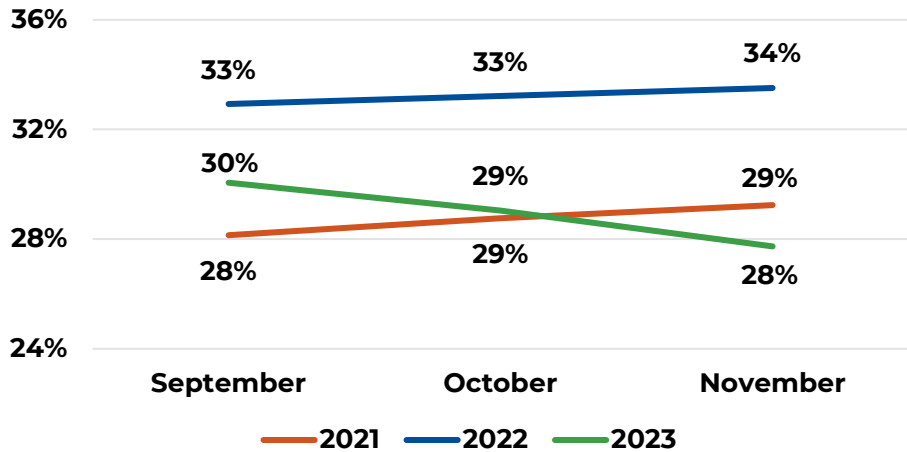

Enrollment & Utilization (Cont.)

Total Members Utilization

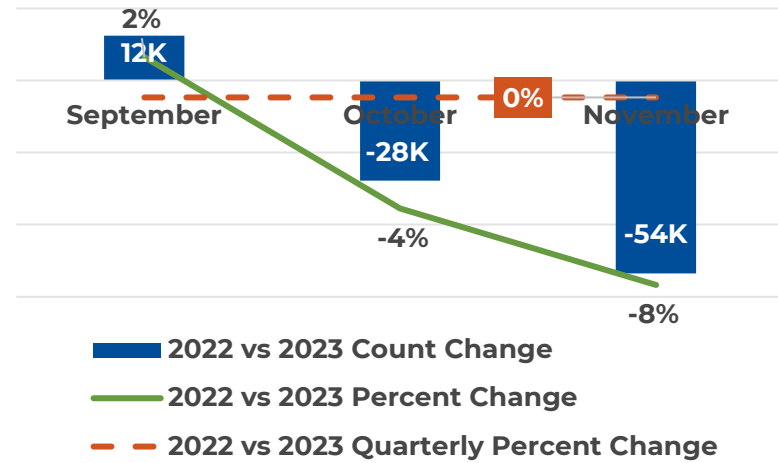
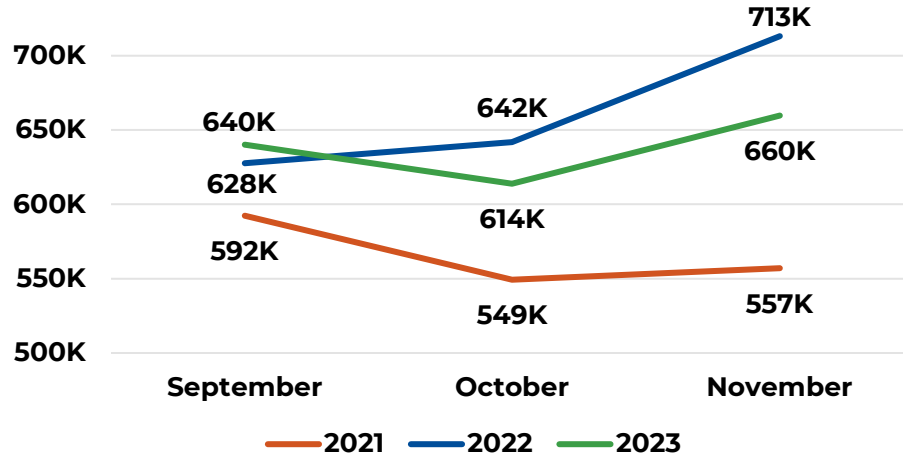

Aged/Blind/Disabled Utilization

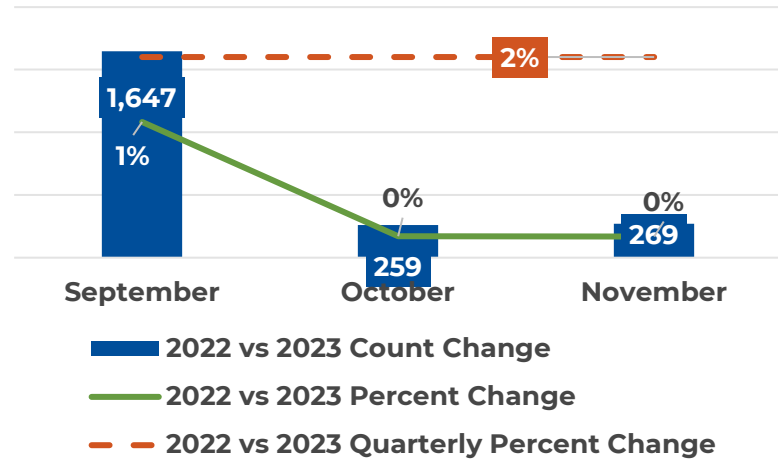
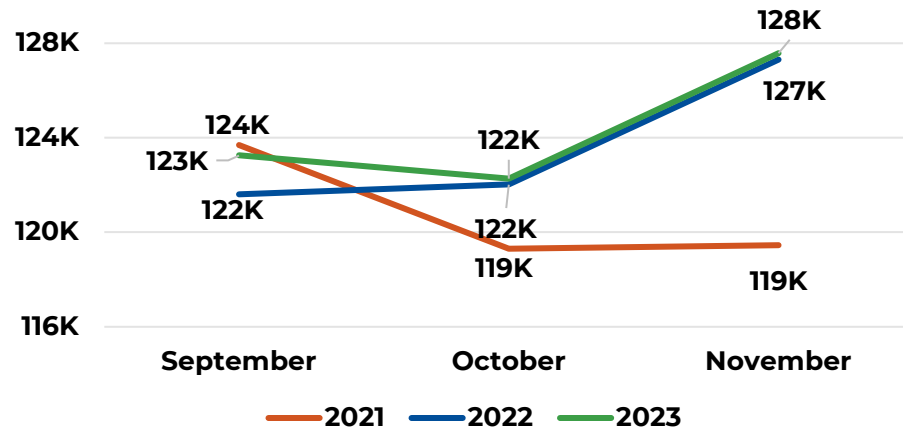

Enrollment & Utilization (Cont.)

Children & Parent/Caretaker Utilization

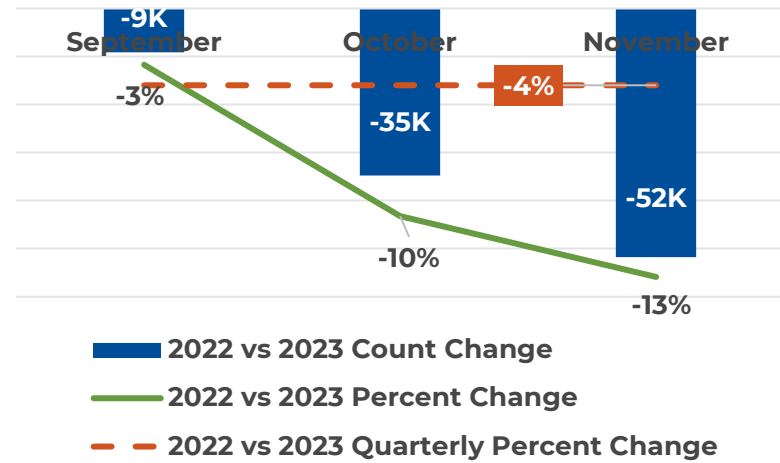
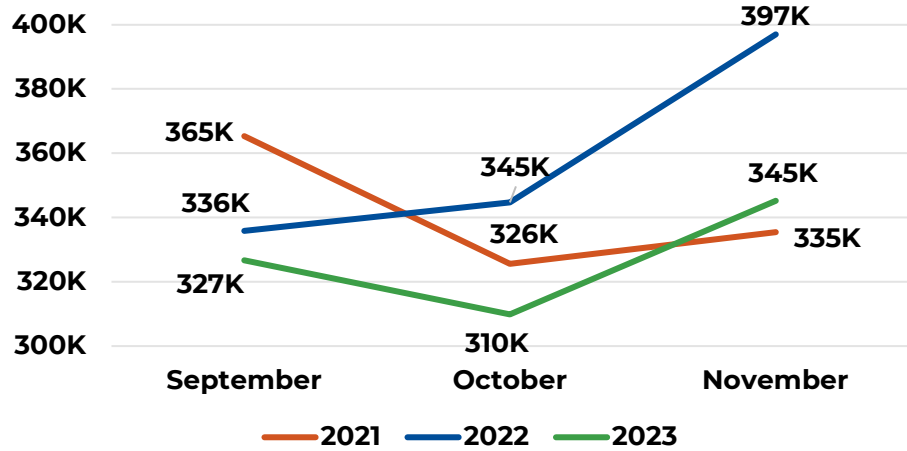

Pregnant (Full Scope) Utilization

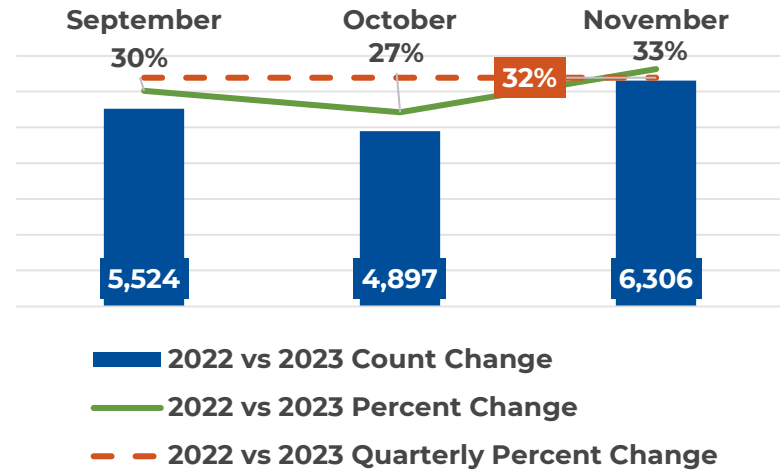
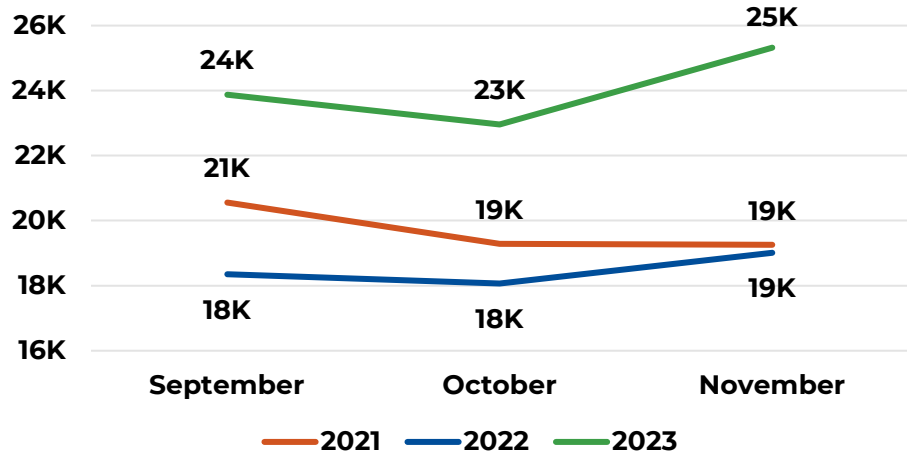

Enrollment & Utilization (Cont.)

Expansion Utilization (Effective July 2021)

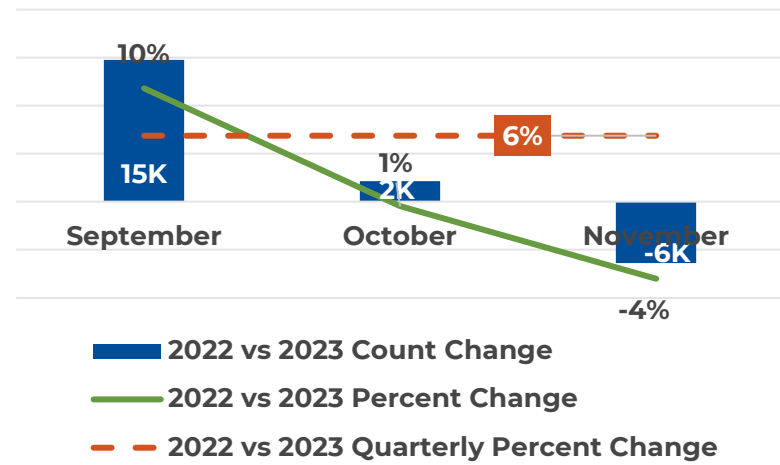
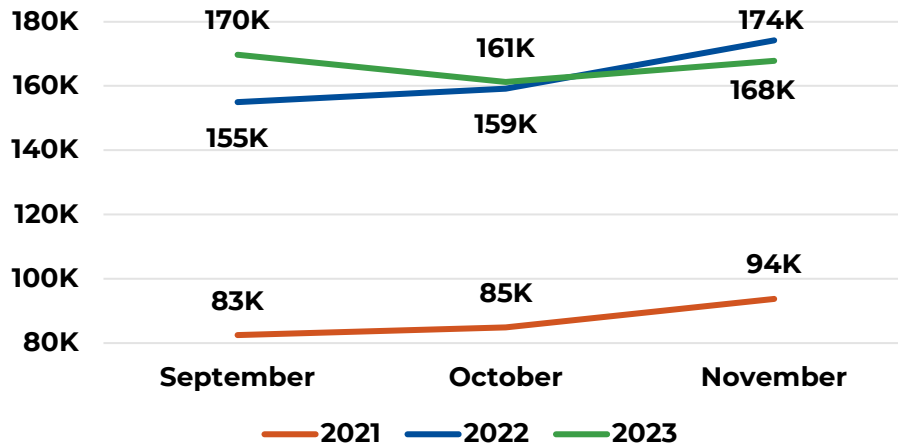

Percent of Total Enrolled Members Utilization

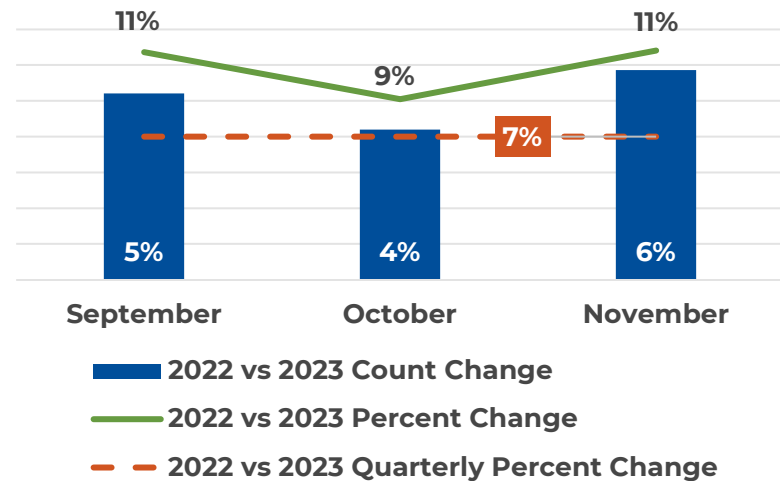
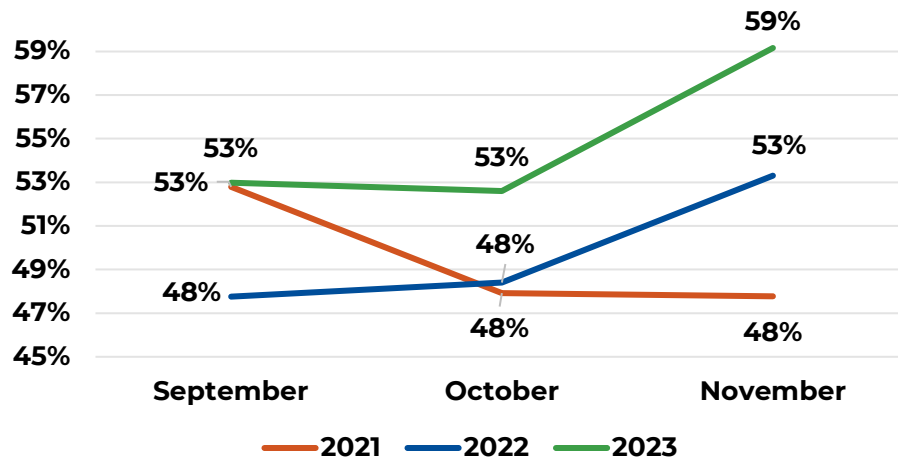

Enrollment & Utilization (Cont.)

Percent of Aged/Blind/Disabled Enrolled Members Utilization

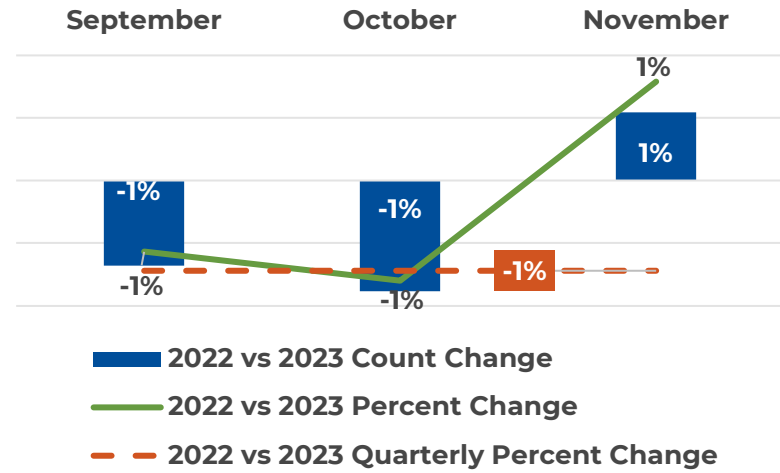
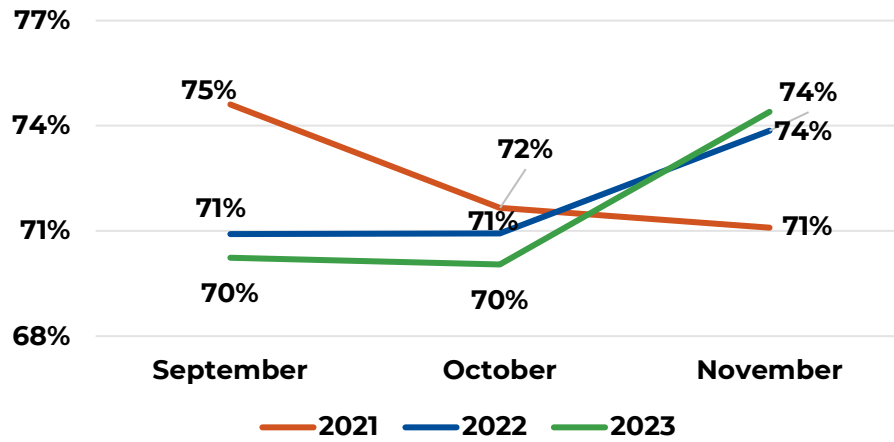

Percent of Children & Parent/Caretaker Enrolled Members Utilization

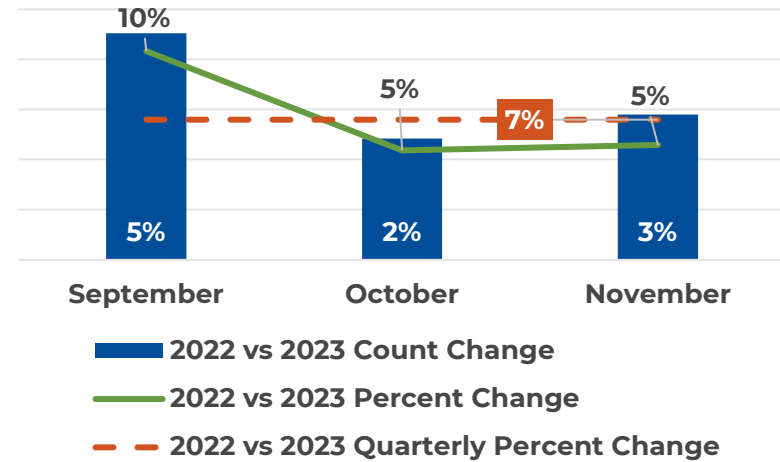
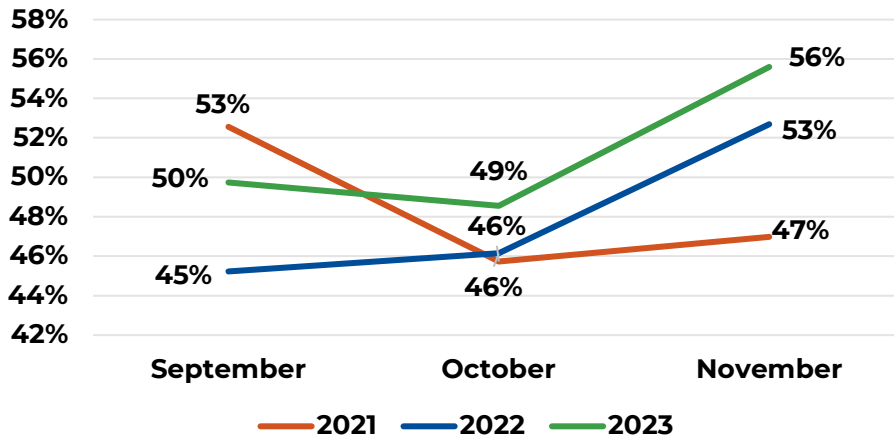

Enrollment & Utilization (Cont.)

Percent of Pregnant (Full Scope) Enrolled Members Utilization

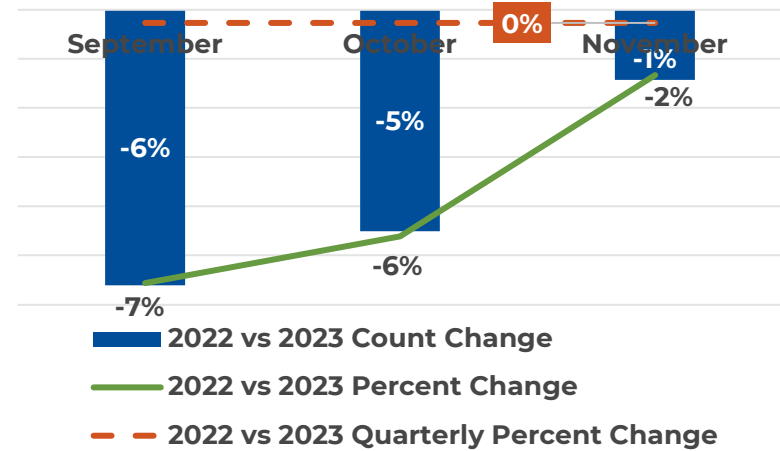
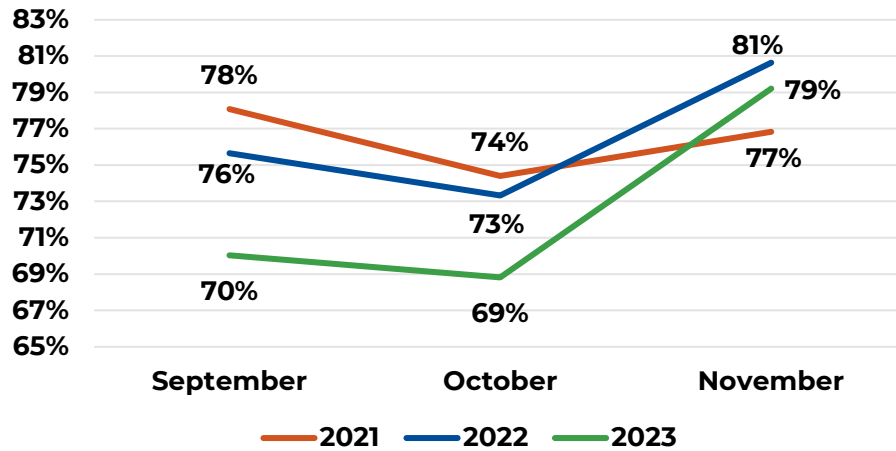

Percent of Expansion Enrolled Members Utilization (Effective July 2021)

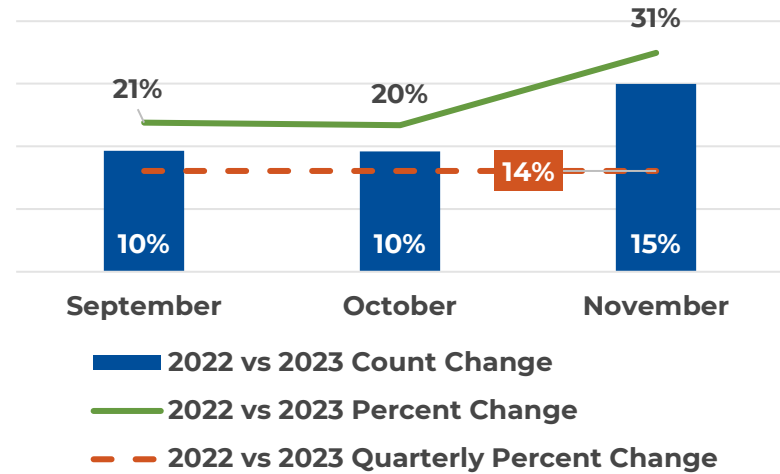
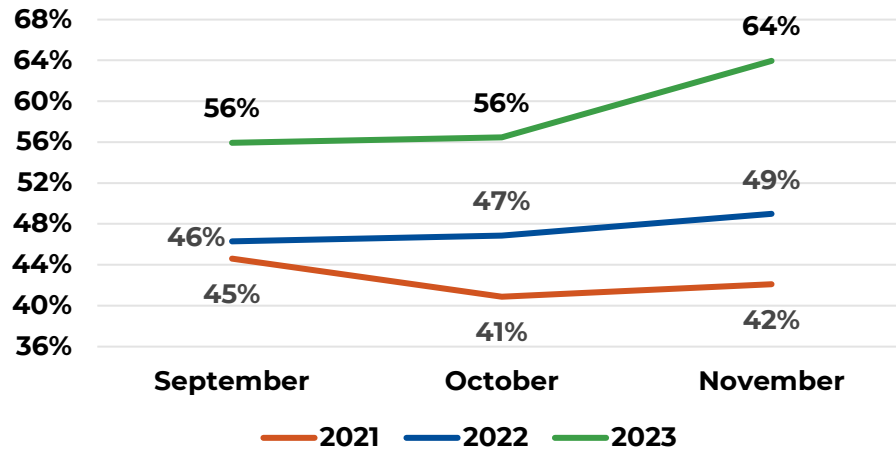

Utilization

Emergency Department Visits (Claims)

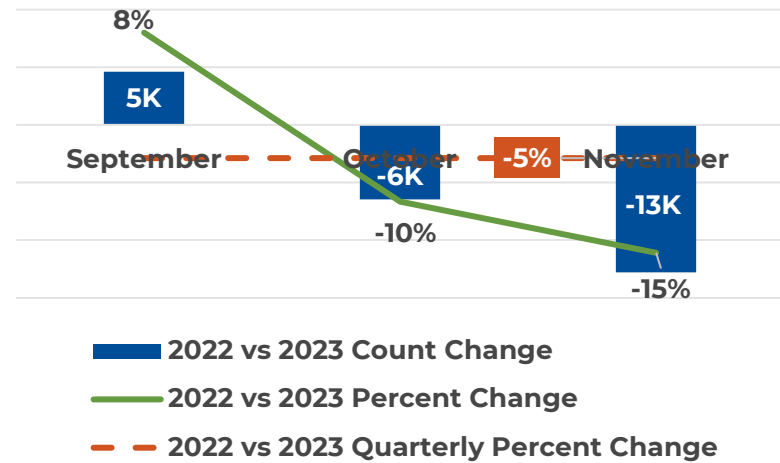
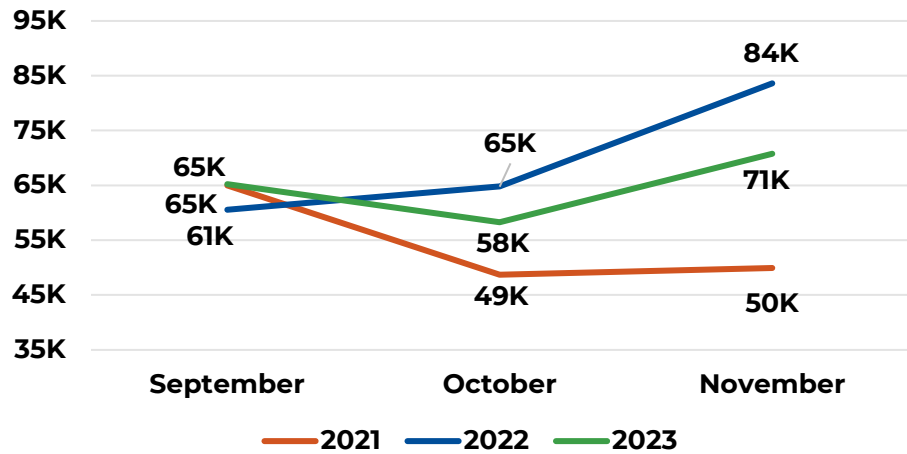

Members Utilizing Emergency Department

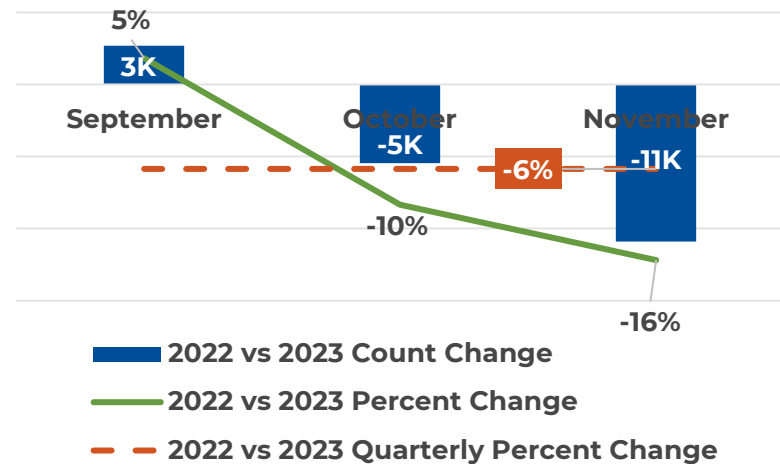
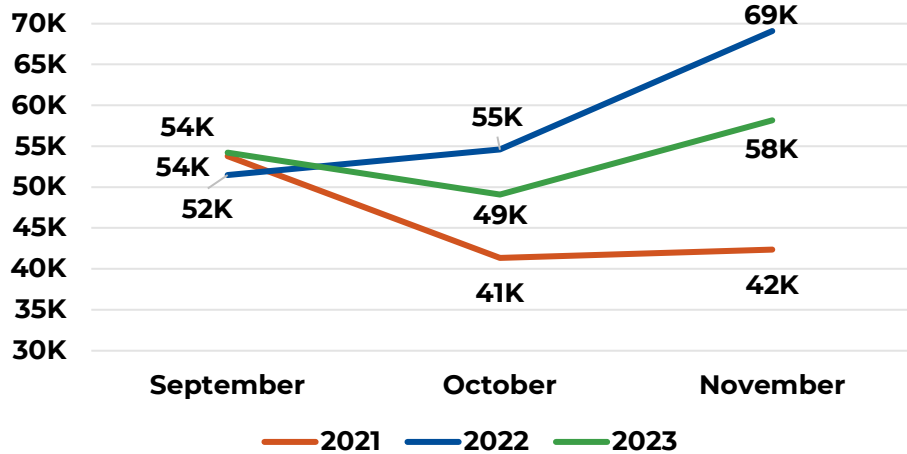

Utilization (Cont.)

Percent Total Enrolled Using ED

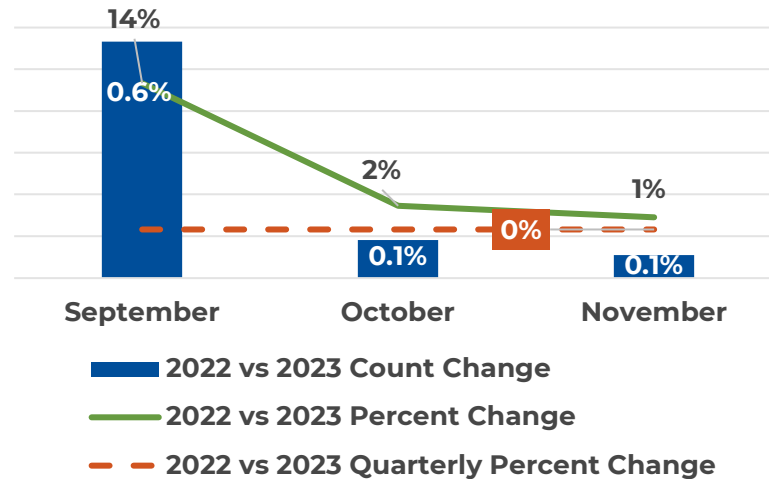
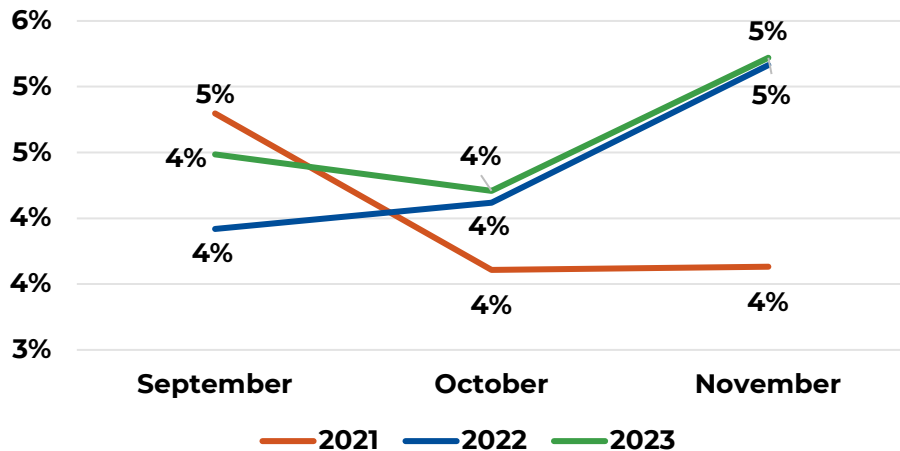

Members Utilizing Emergency Department By Qualifying Group

Q2 2023

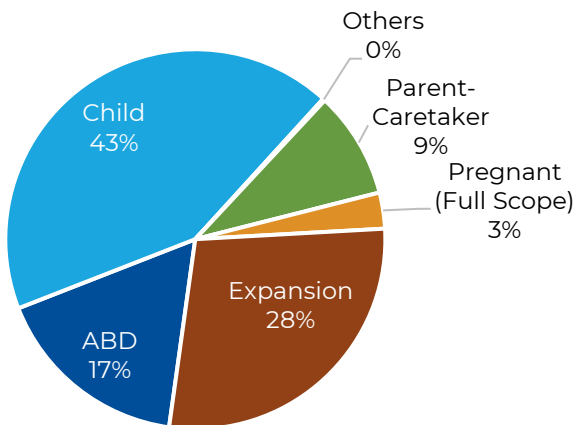

Q2 2024

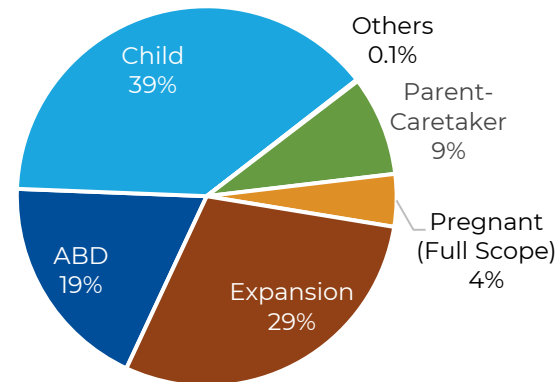

Utilization (Cont.)

Telemedicine - Total Visits

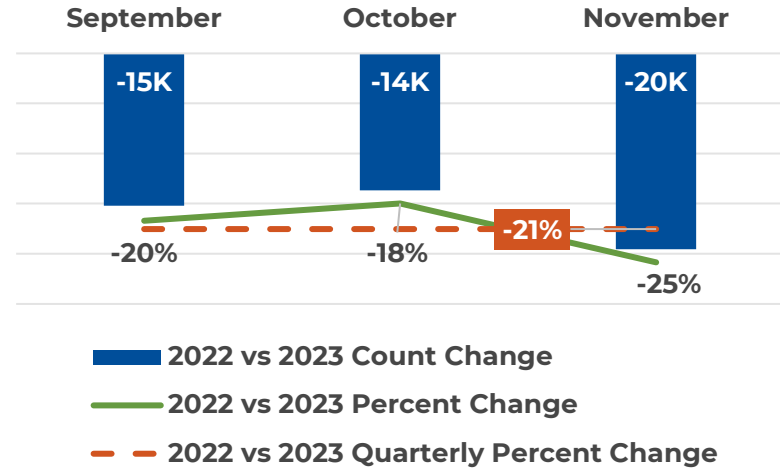
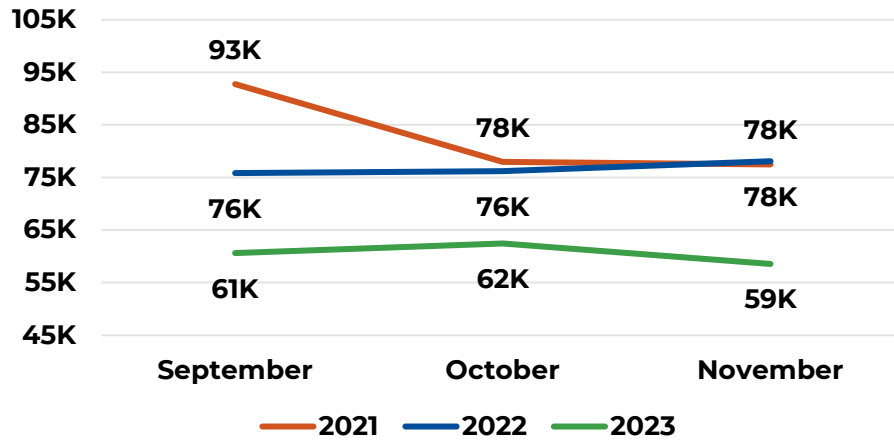

Members With Opioid Claims

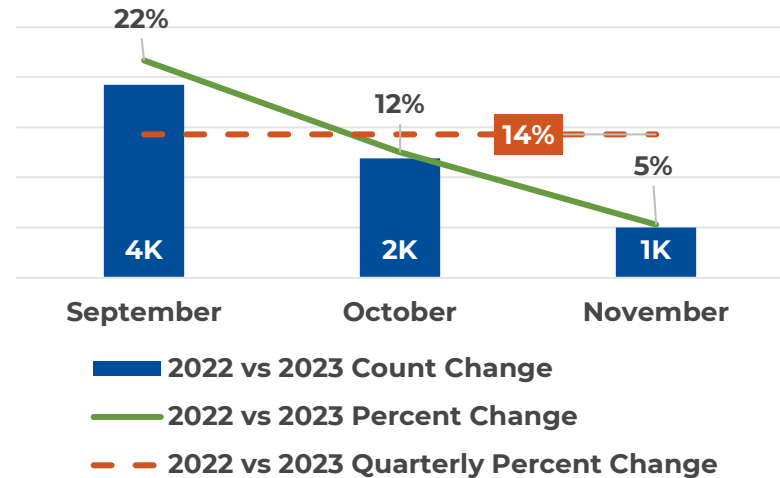
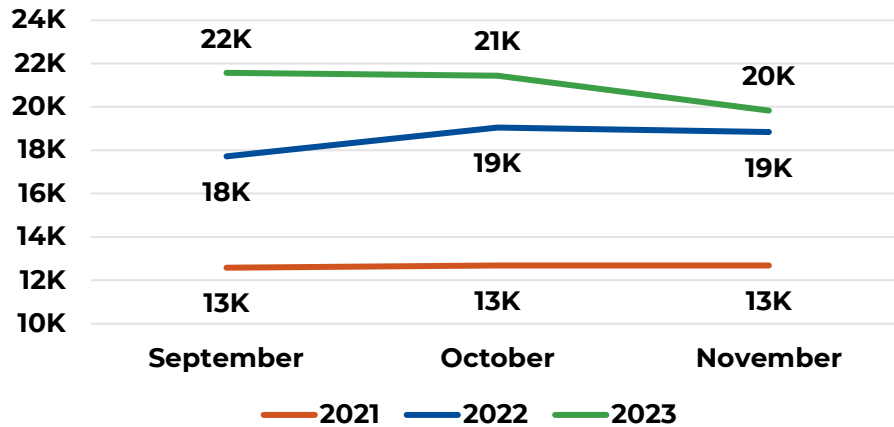

Utilization (Cont.)

Members With Opioid Claims By Qualifying Group

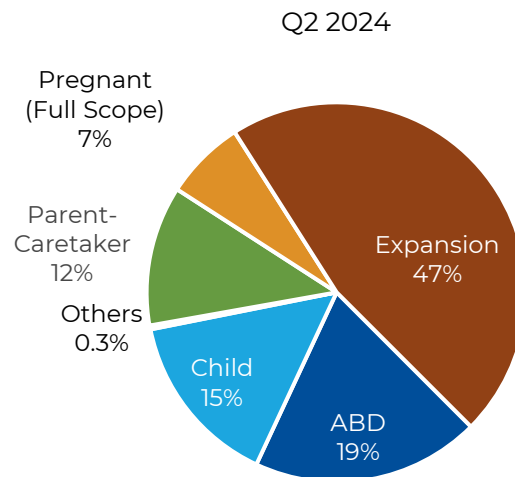
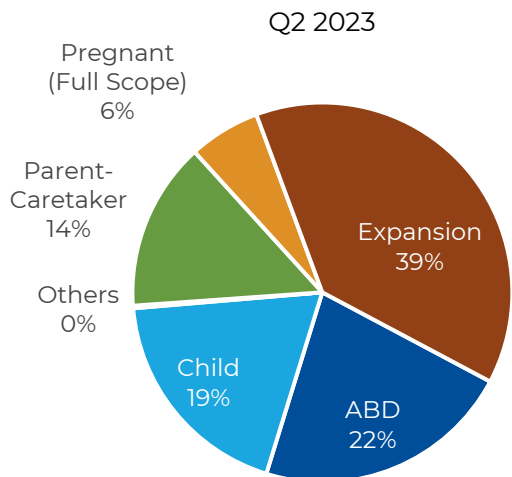

Total Opioid Claims

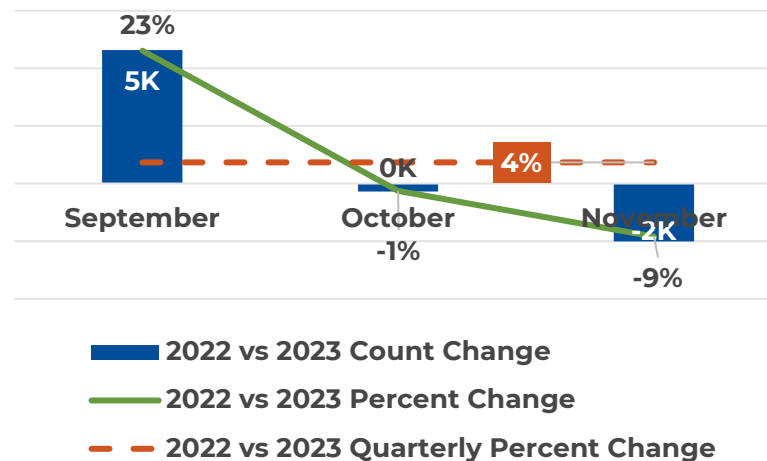
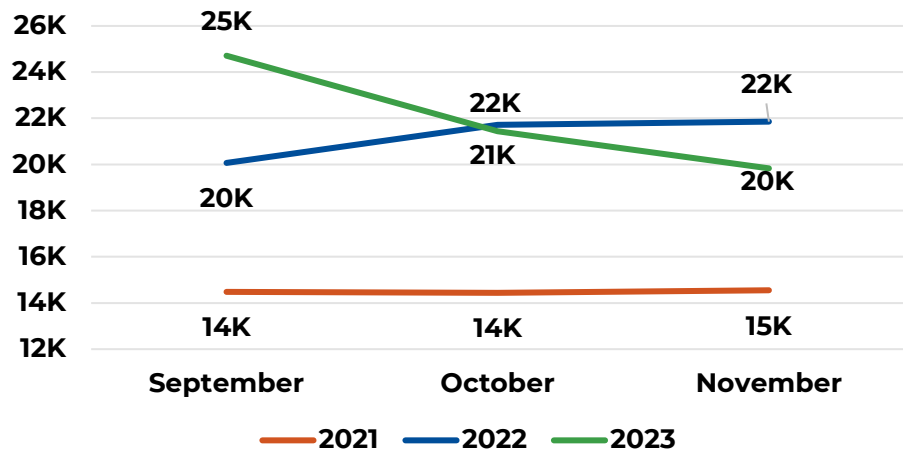

Utilization (Cont.)

Out of State Services (Non Border County) - Total Members Utilization

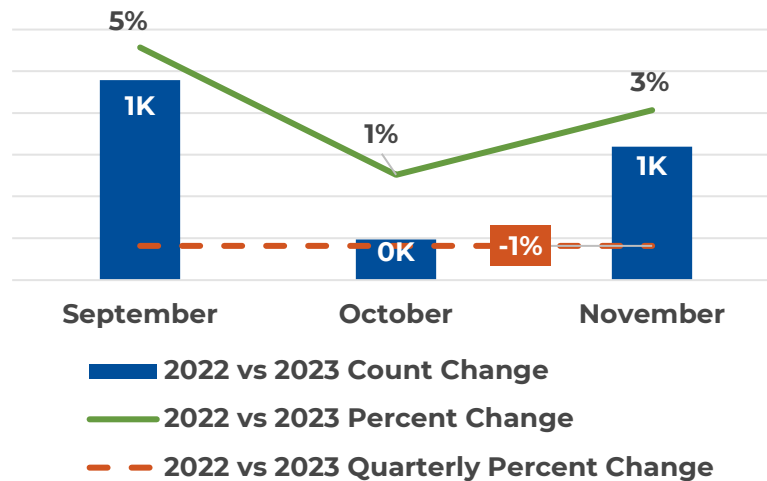
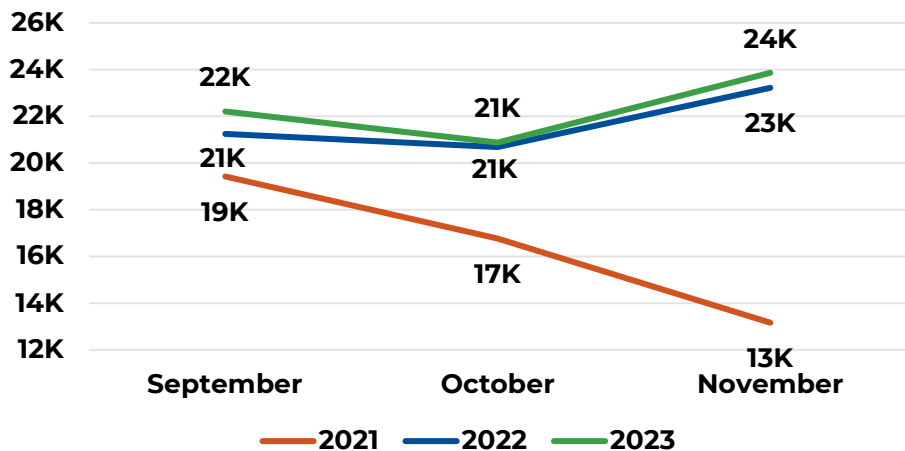

Out of State Services (Non Border County) - Total Members Utilization By Qualifying Group

Q2 2023

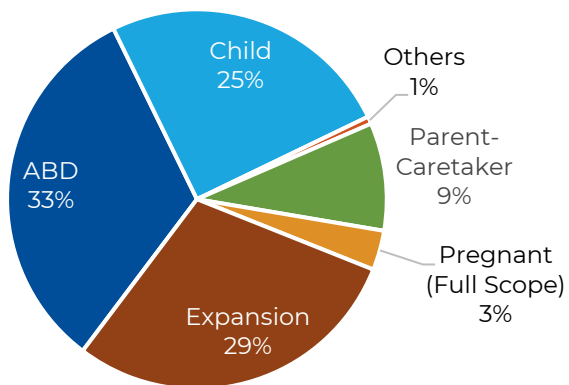

Q2 2024

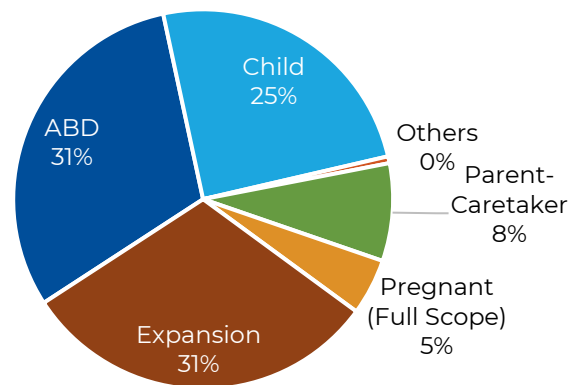

Utilization (Cont.)

Out of State Services (Non Border County) - Total Reimbursements

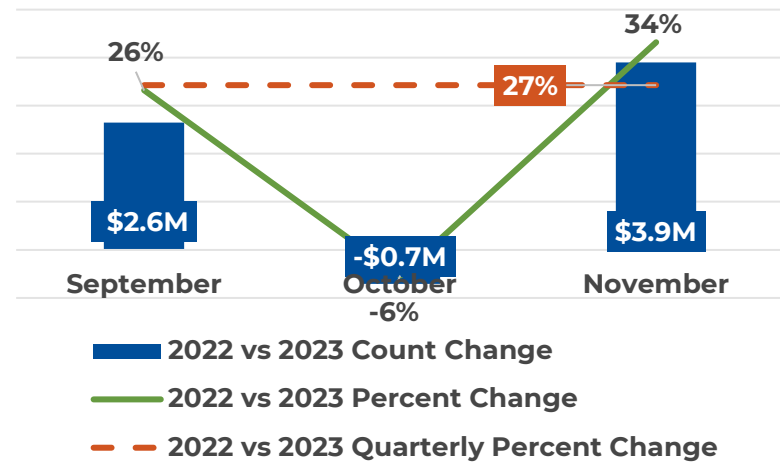
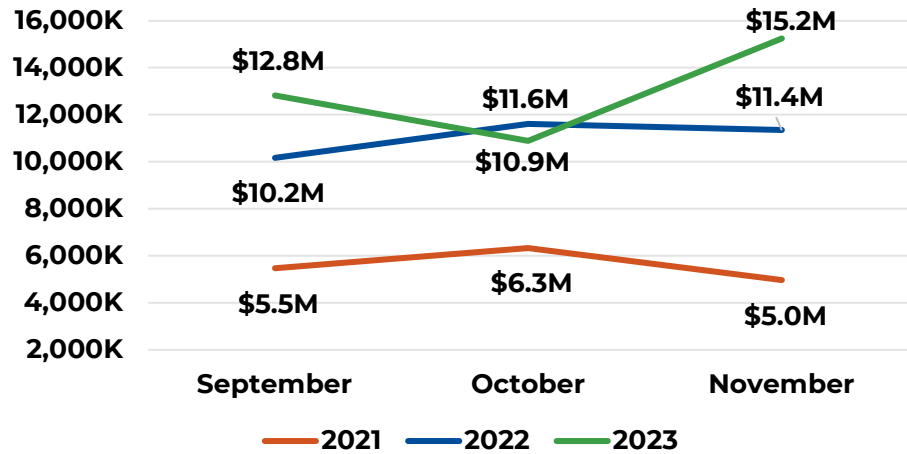

Out of State Services (Non Border County) - Total Active Billing Providers

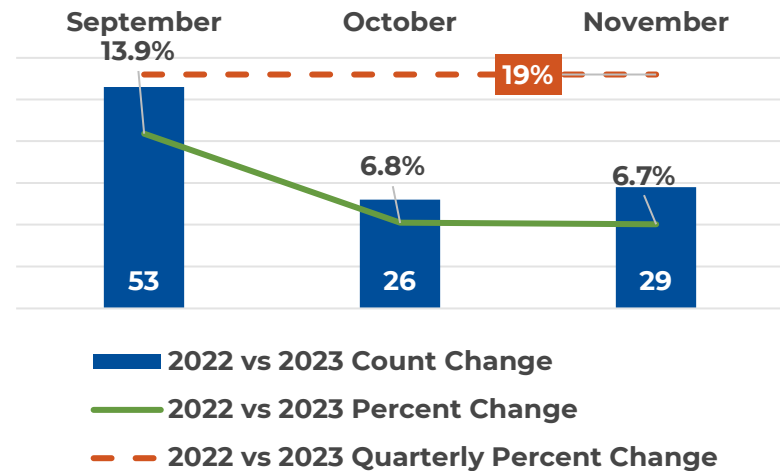
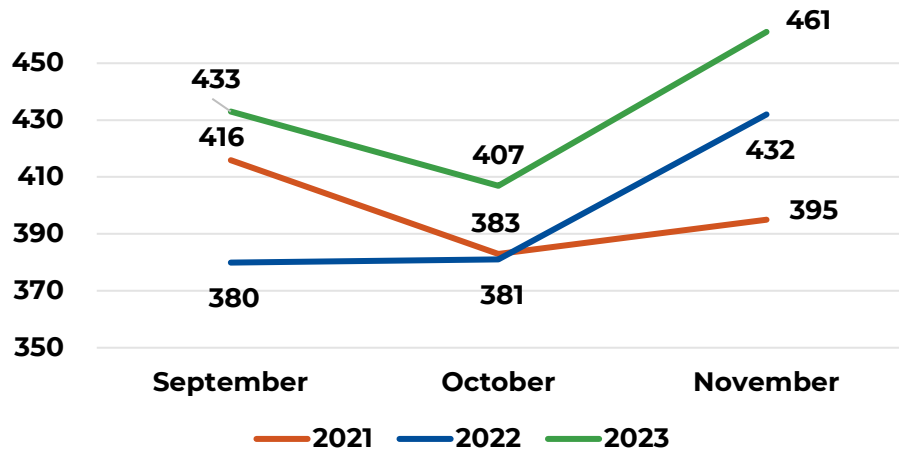

Utilization (Cont.)

Dental Claims

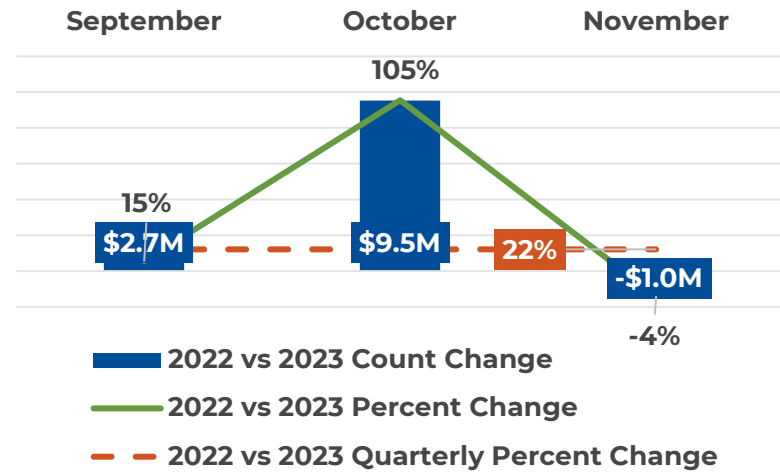
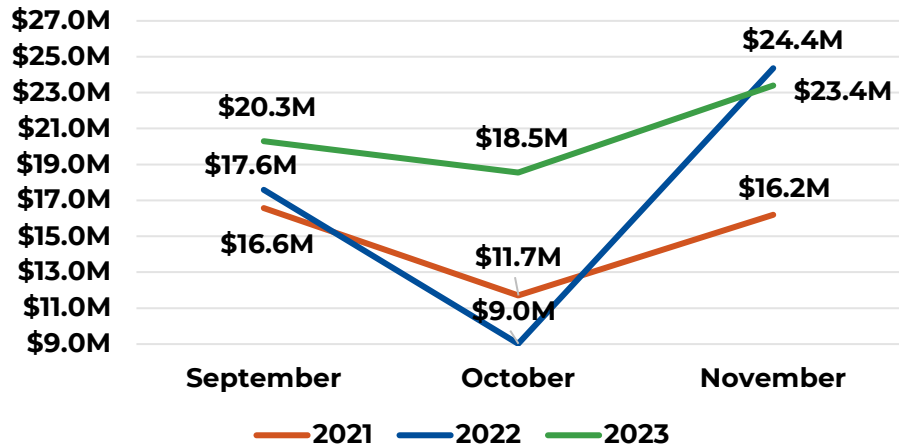

Total Members with Dental Claims

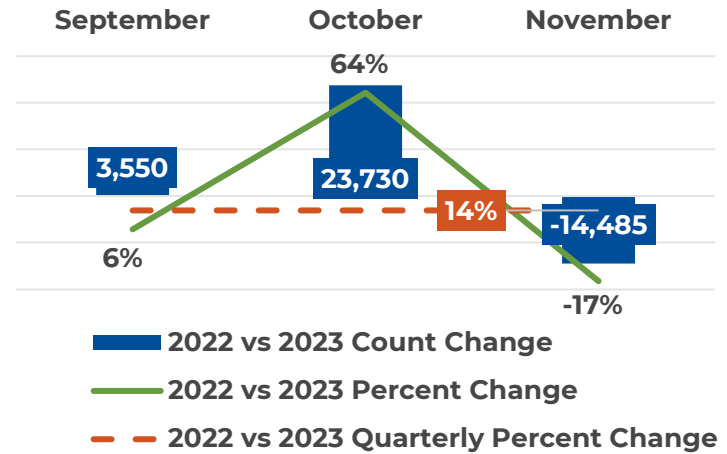
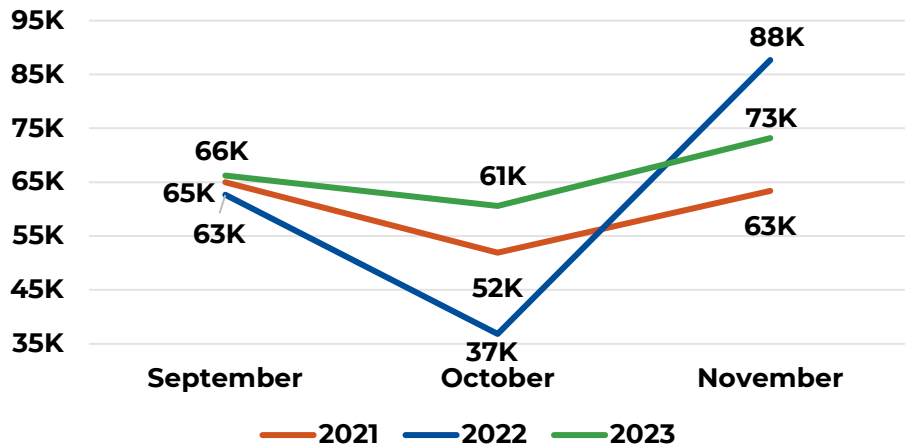

Utilization (Cont.)

Adult (21 & Over) Dental Claims

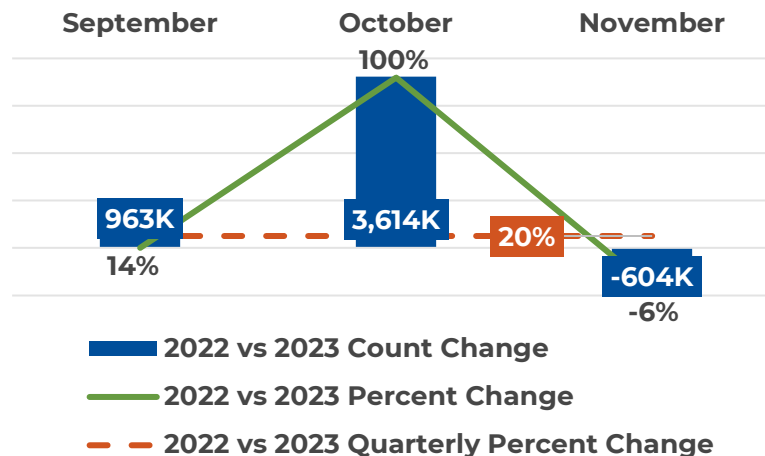
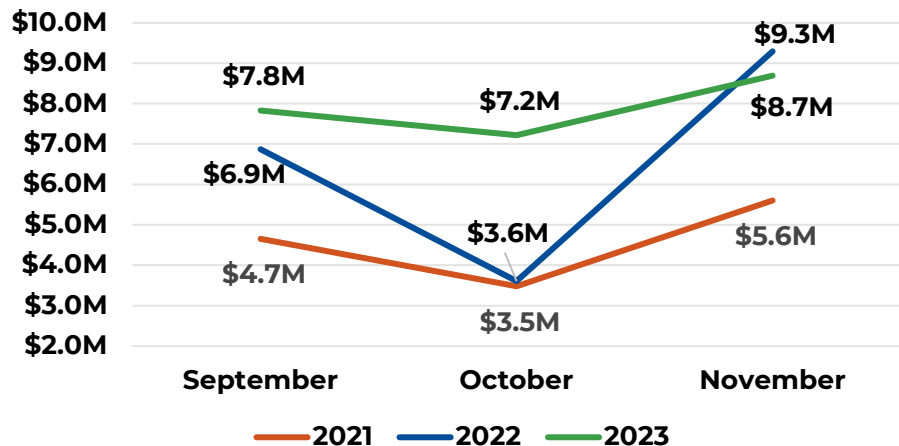

Adults (21 & Over) with Dental Claims

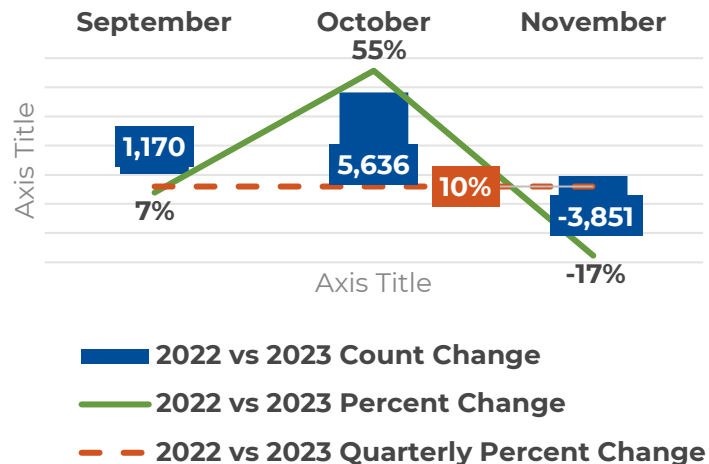
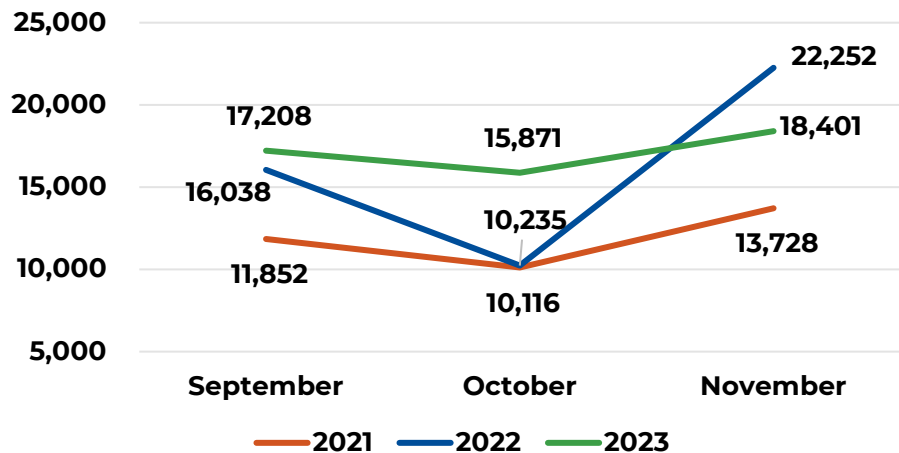

Utilization (Cont.)

Children (Under 21) Dental Claims

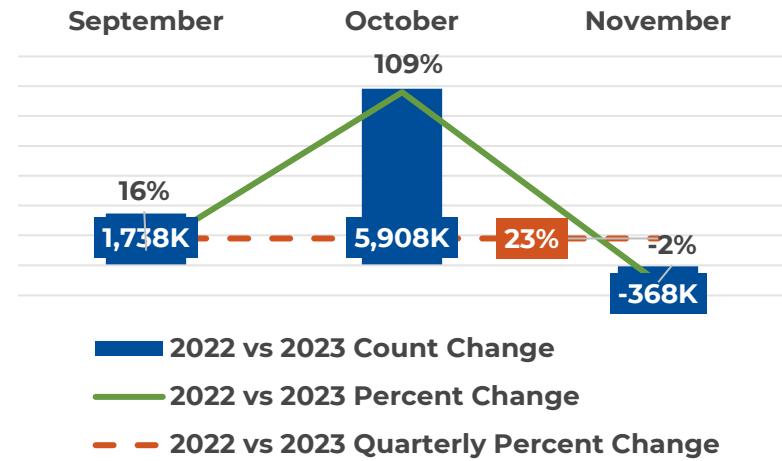
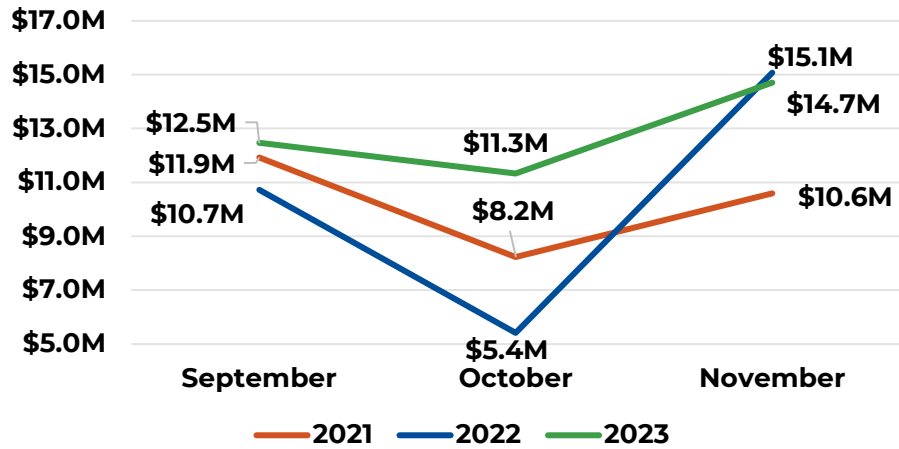

Children (Under 21) with Dental Claims

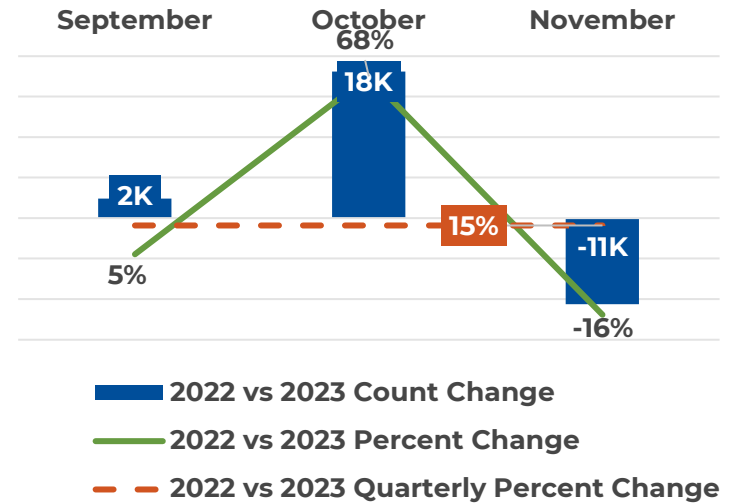
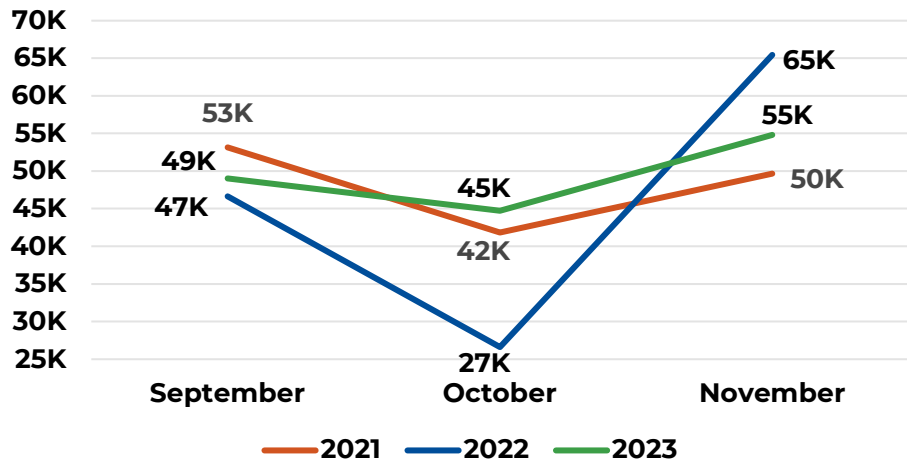

Utilization (Cont.)

Members With Dental Claims By Qualifying Group

Q2 2023

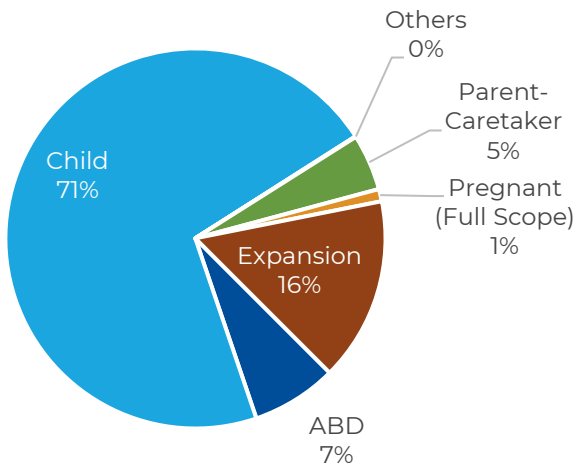

Q2 2024

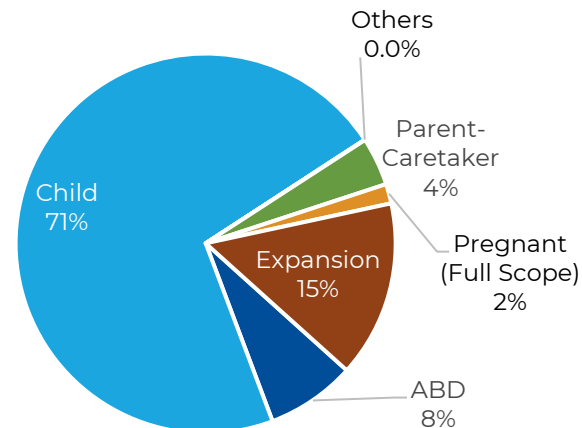

Financials

Total Agency Expenditures

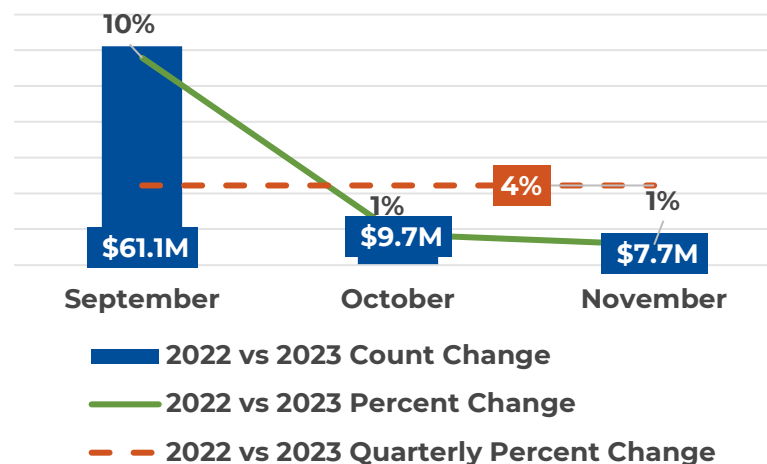
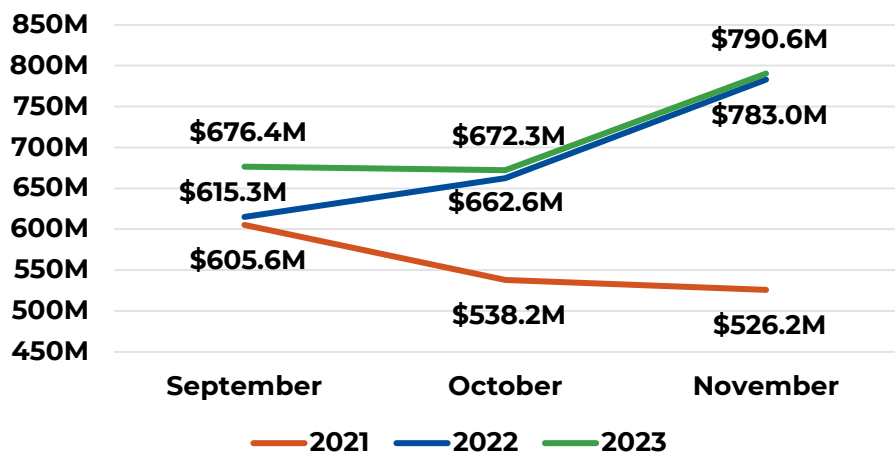

Financials (Cont.)

Total Agency Members Utilization by Qualifying Group

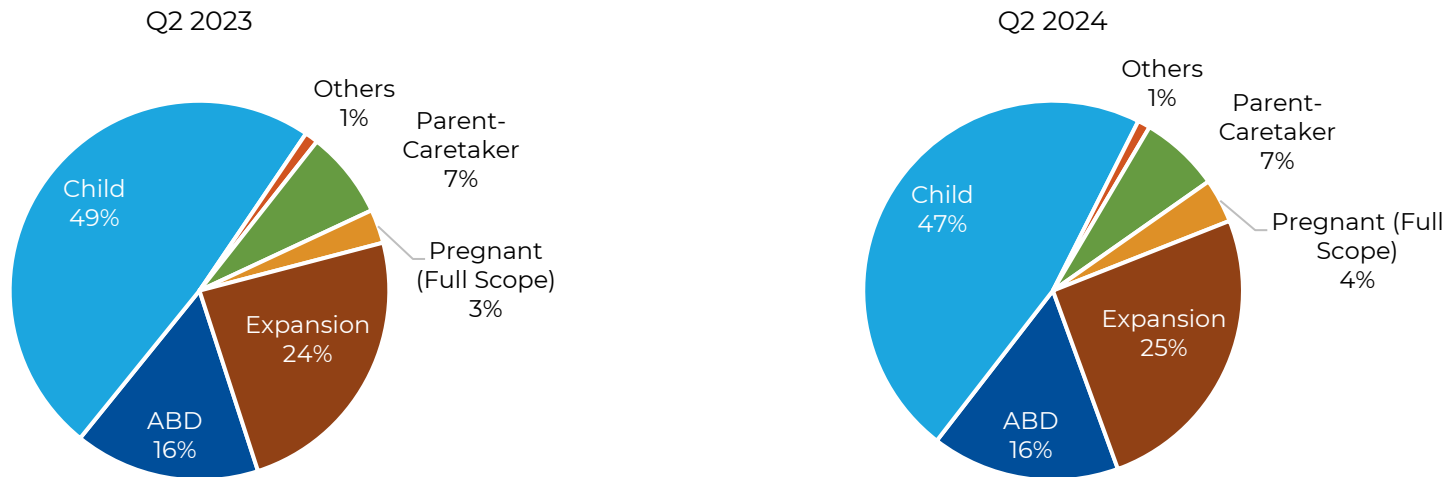

Inpatient Services Expenditures

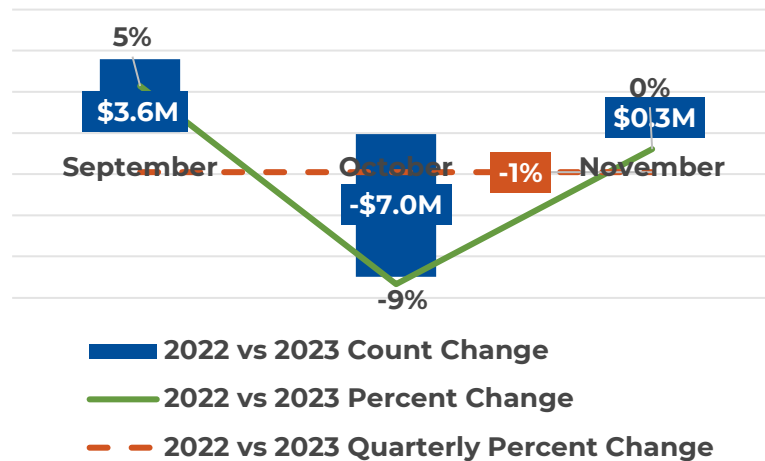
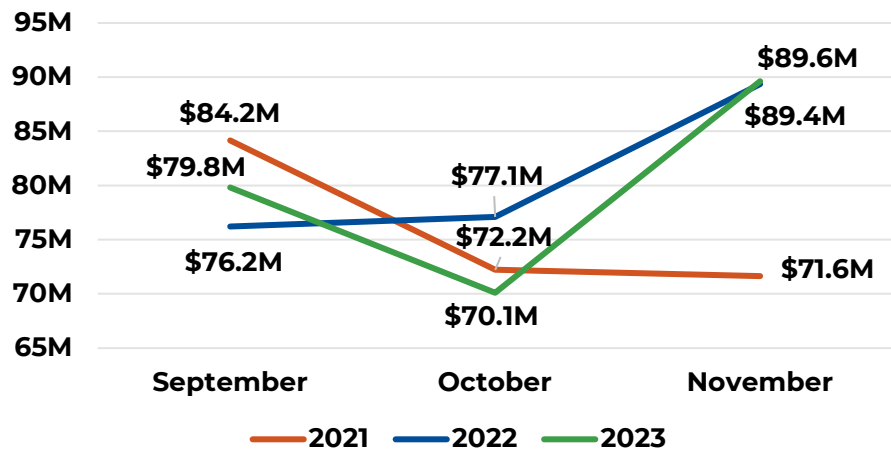

Financials (Cont.)

Inpatient Services Members Utilization by Qualifying Group

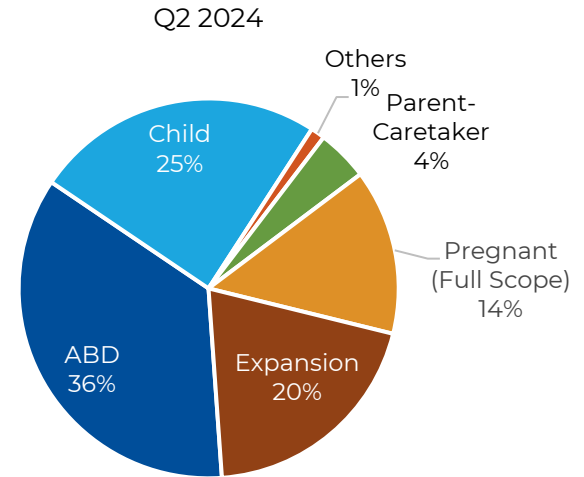
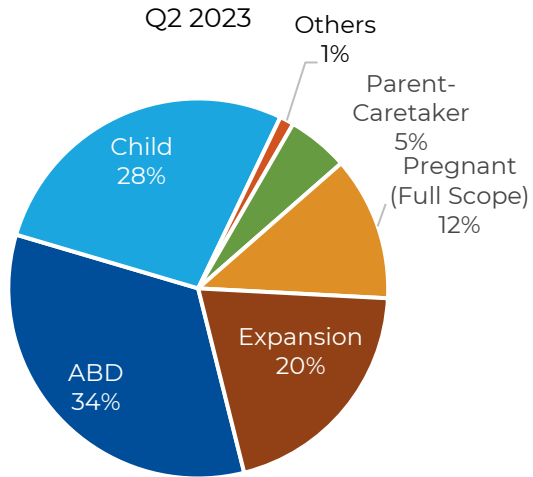

Nursing Facility Expenditures

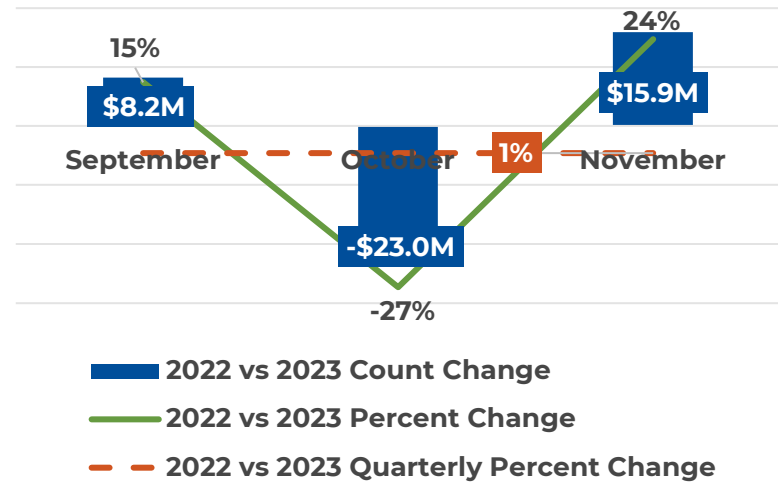
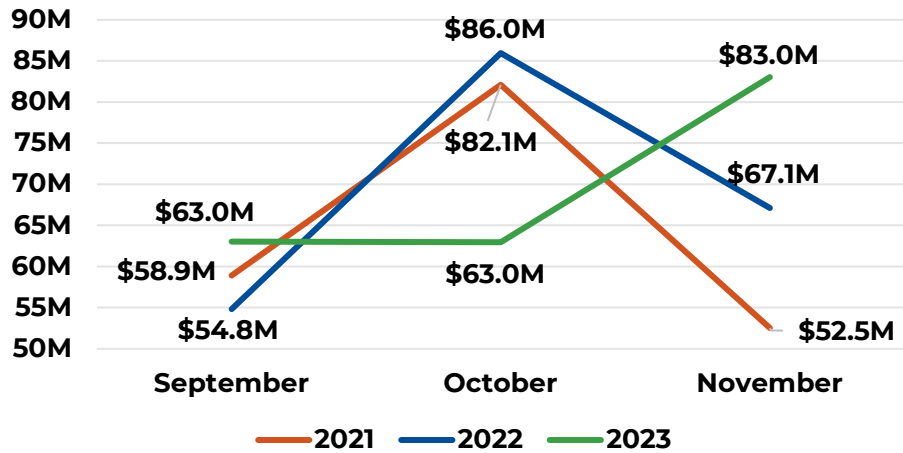

Financials (Cont.)

Outpatient Hospital Expenditures

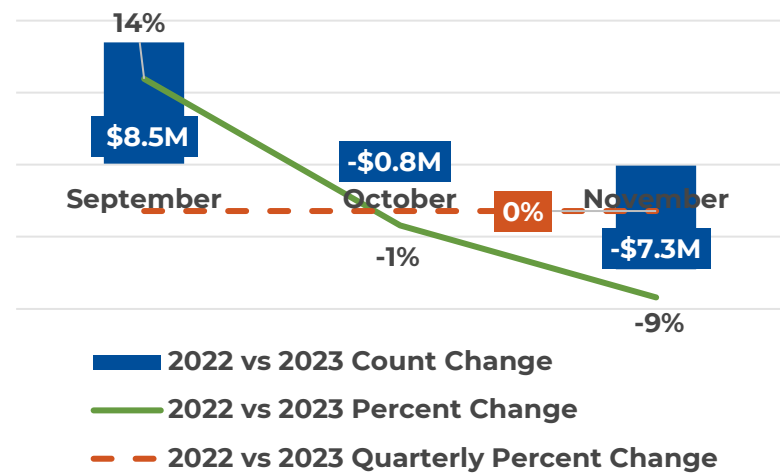
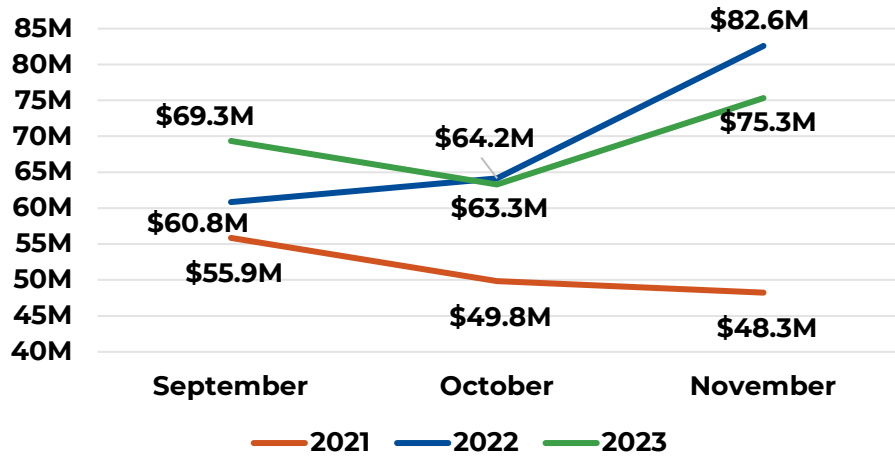

Outpatient Hospital Members Utilization by Qualifying Group

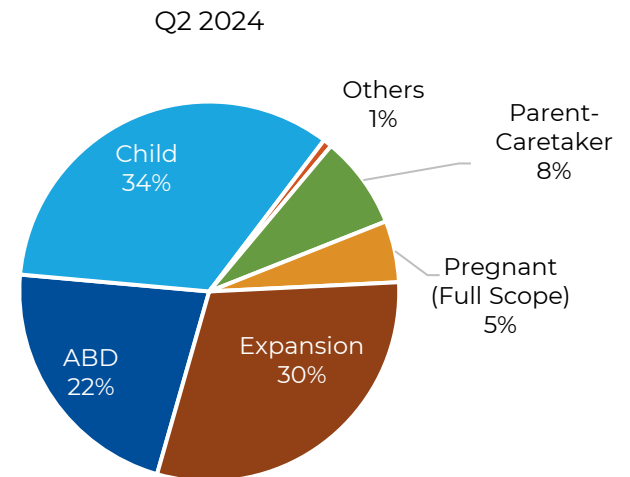
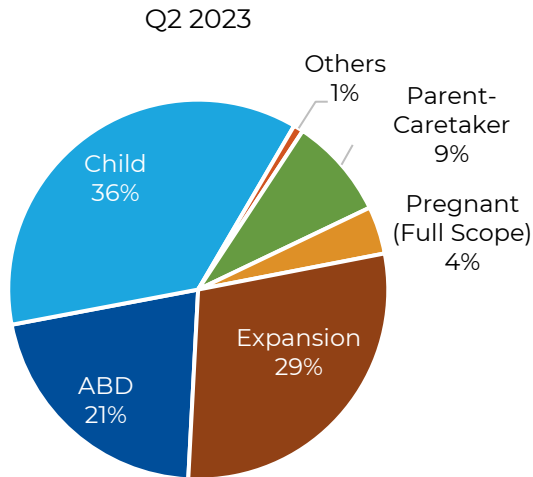

Financials (Cont.)

Physician Expenditures

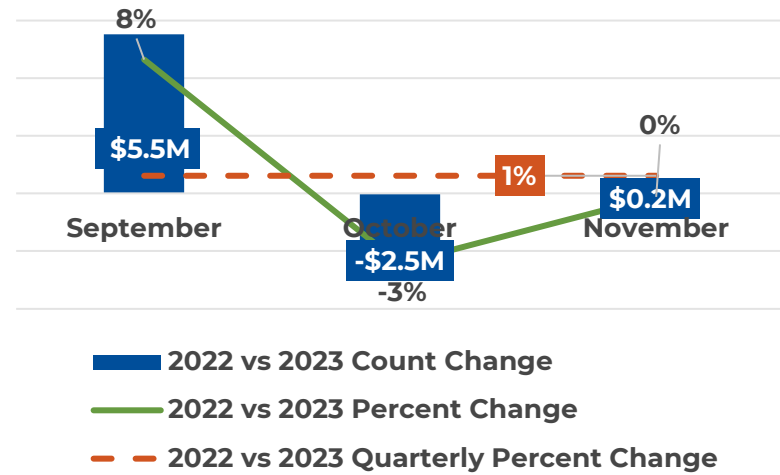
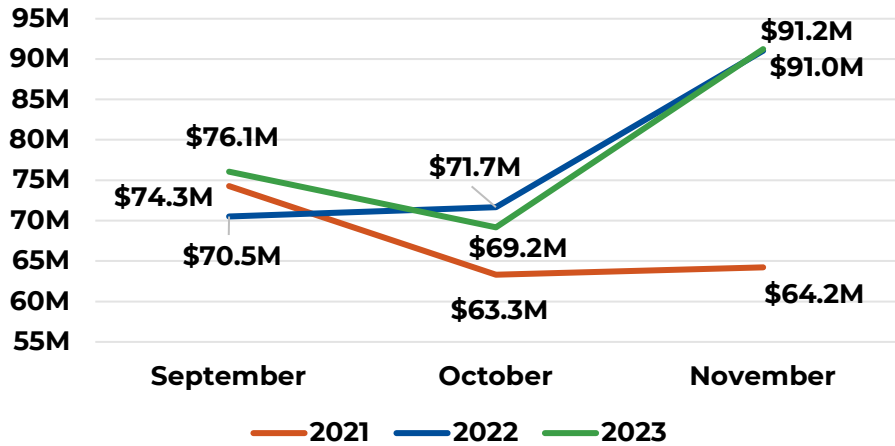

Physician Members Utilization By Qualifying Group

Q2 2023

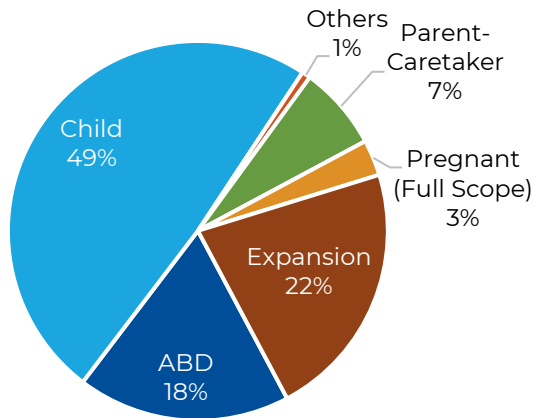

Q2 2024

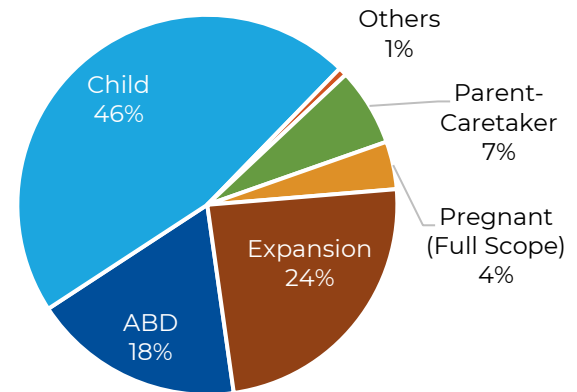

Financials (Cont.)

Prescribed Drugs Expenditures

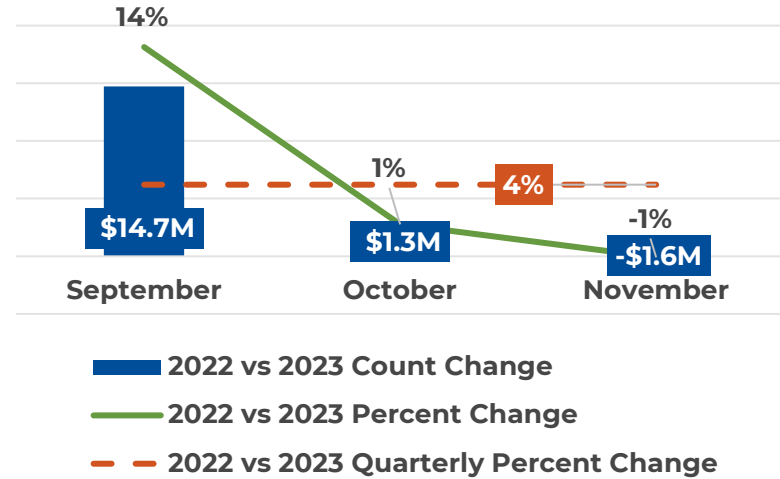
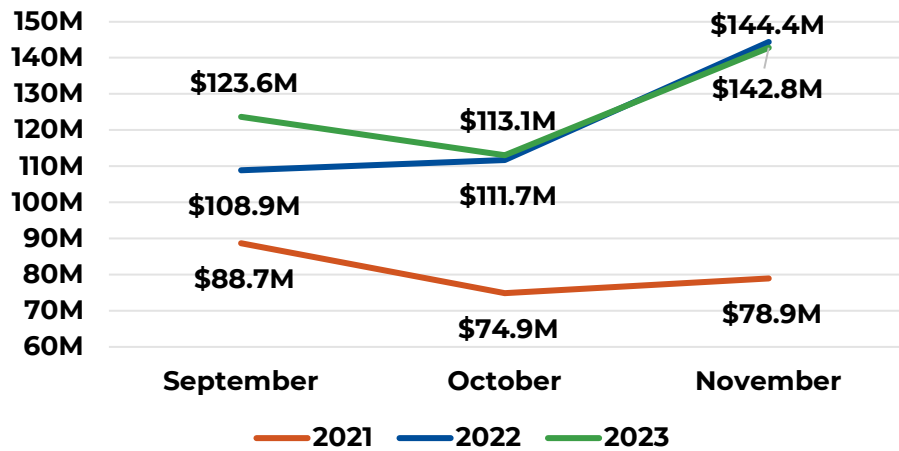

Prescribed Drugs Members Utilization By Qualifying Group

Q2 2023

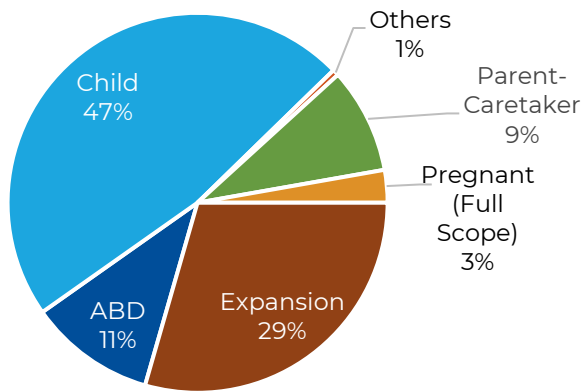

Q2 2024

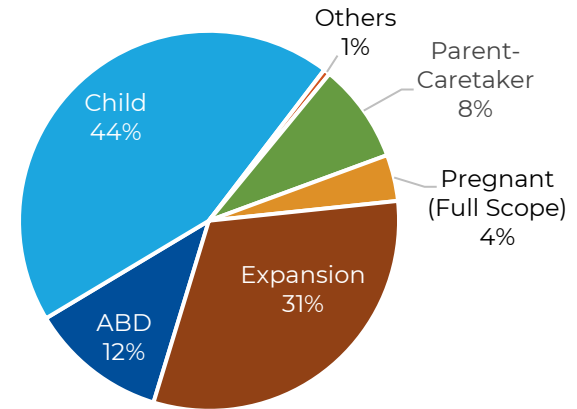

Financials (Cont.)

Average Per Total Member Served

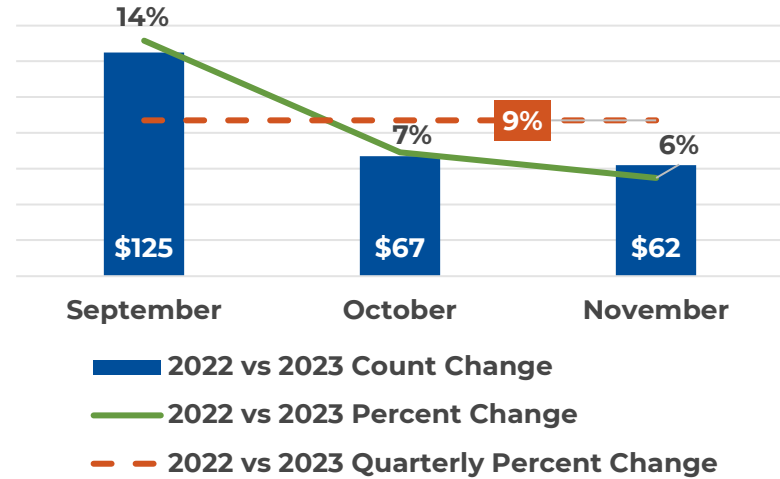
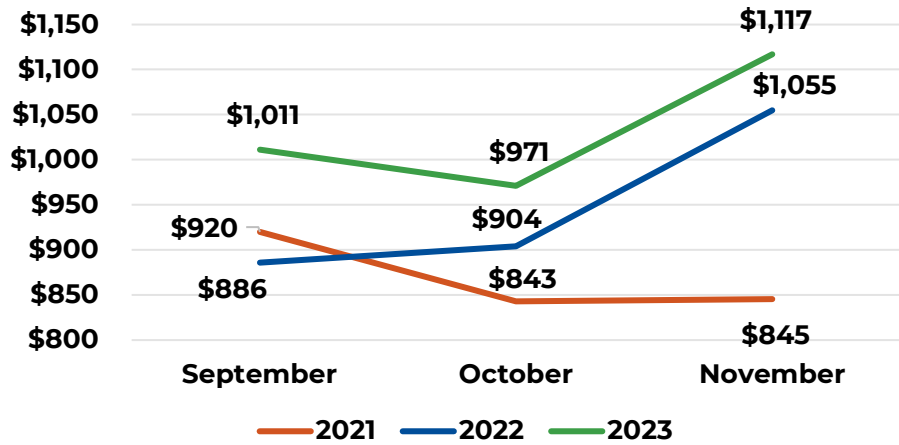

Average Per Child (Under 21) Member Served

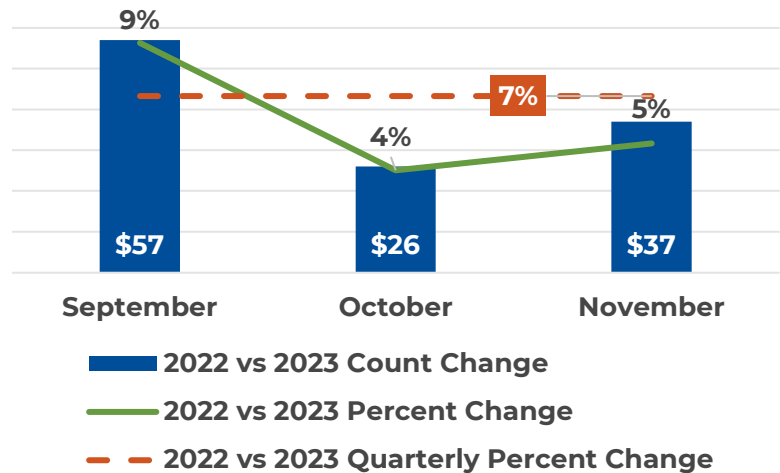
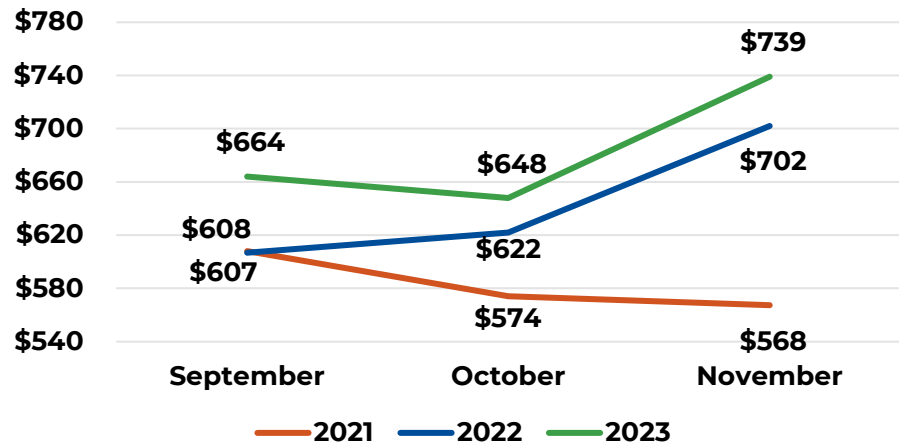

Financials (Cont.)

Average Per Aged/Blind/Disabled Member Served

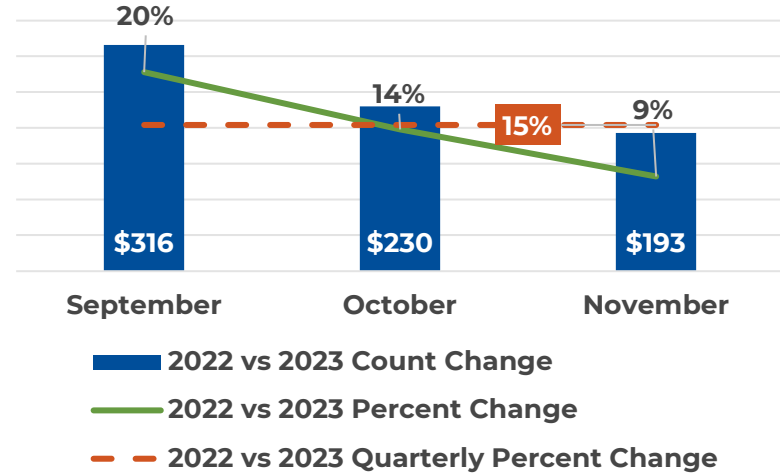
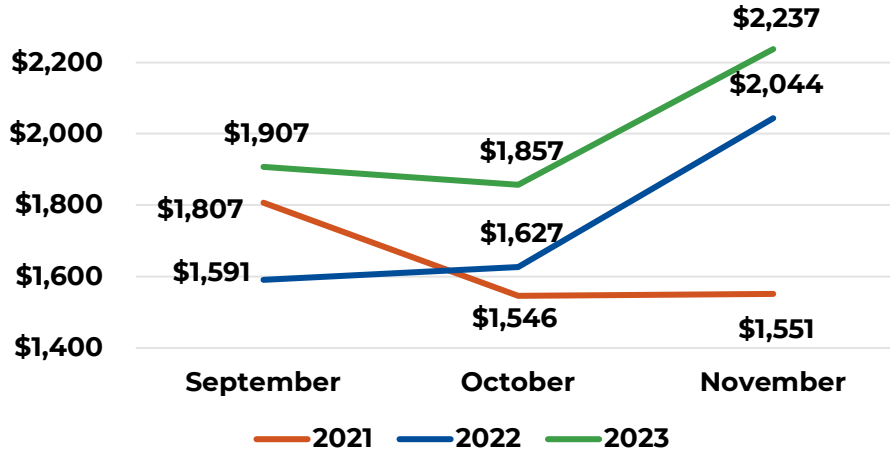

Average Per Children & Parent/Caretaker Member Served

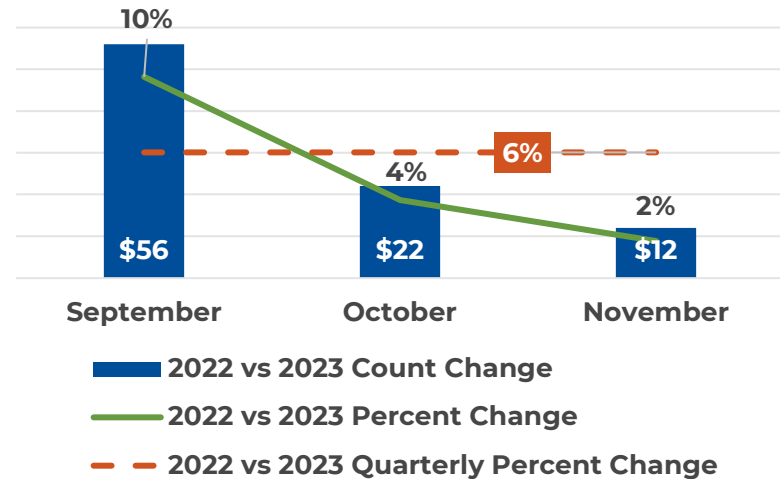
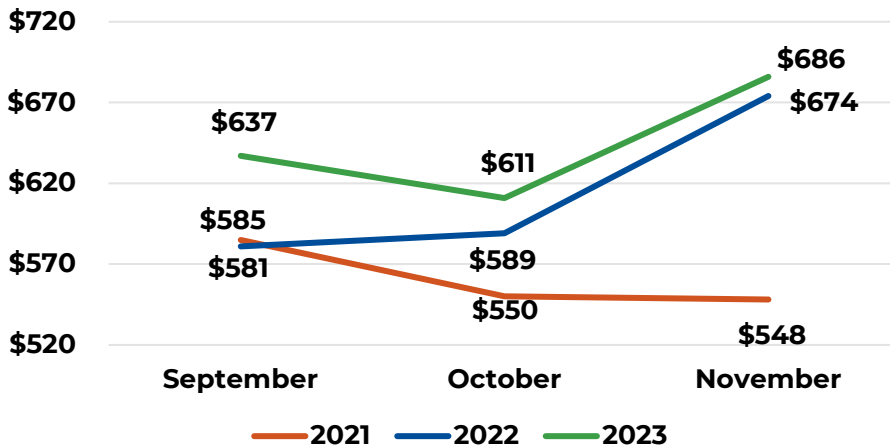

Financials (Cont.)

Average Per Expansion Member Served (Effective July 2021)

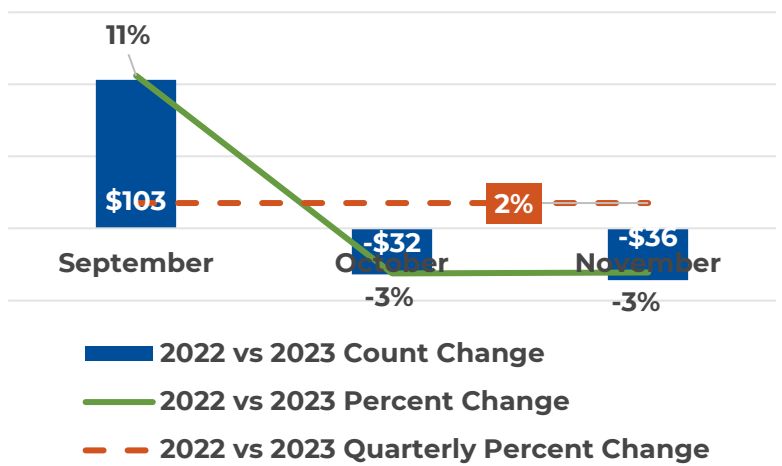
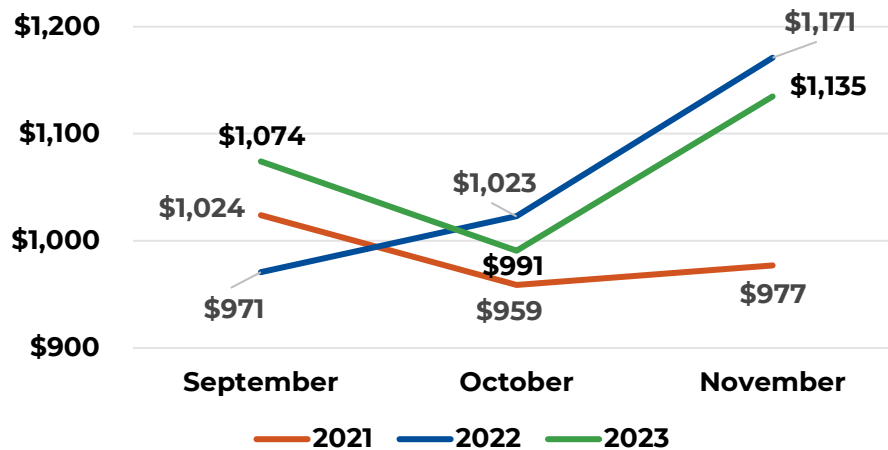

Call Center

Call Center - Member Calls Answered

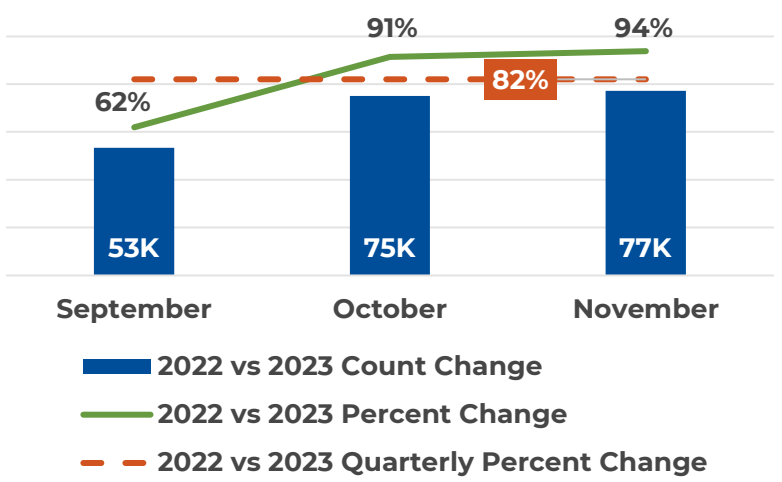
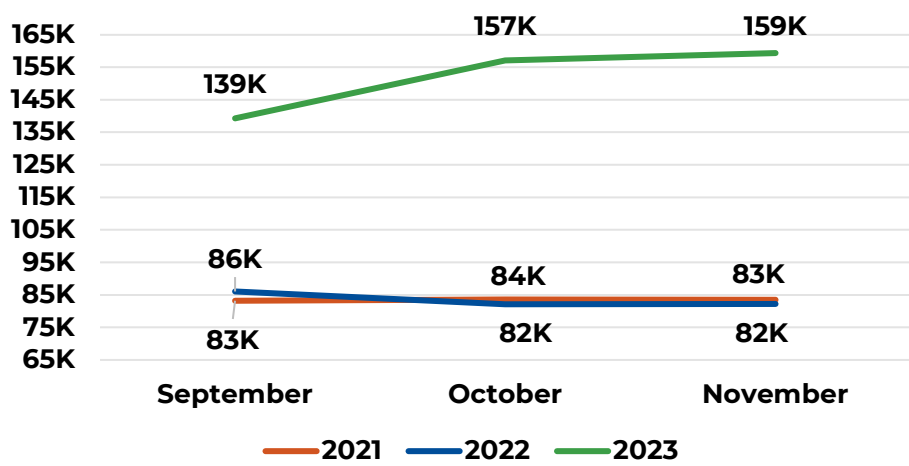

Call Center (Cont.)

Call Center - Average Wait Time (In Seconds)

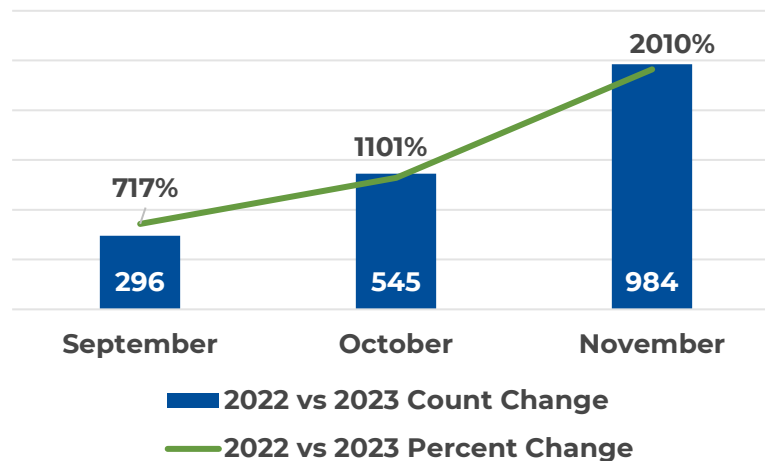
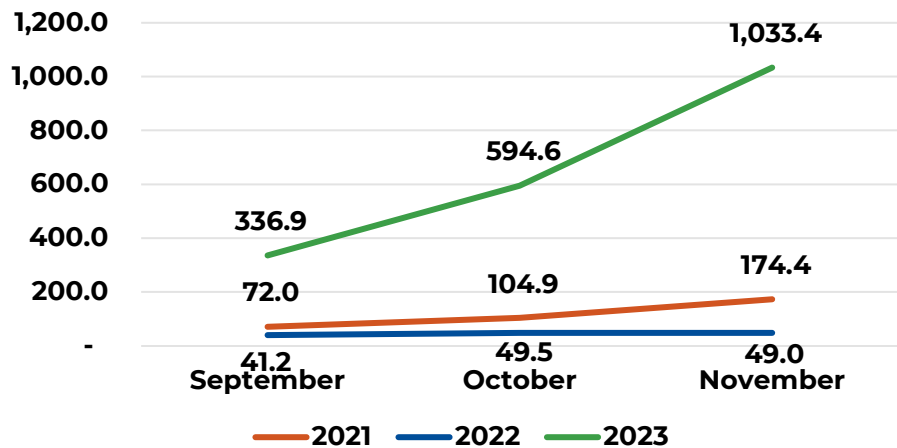

Prior Authorization

Prior Authorization - Total Combined - Total Completed PA Volume

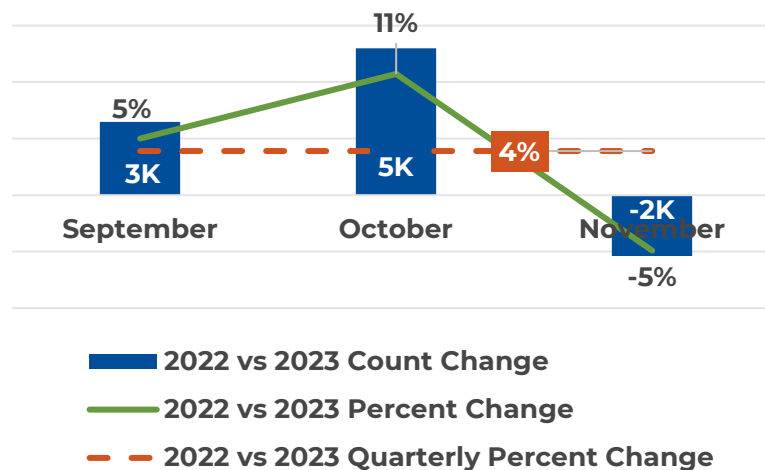
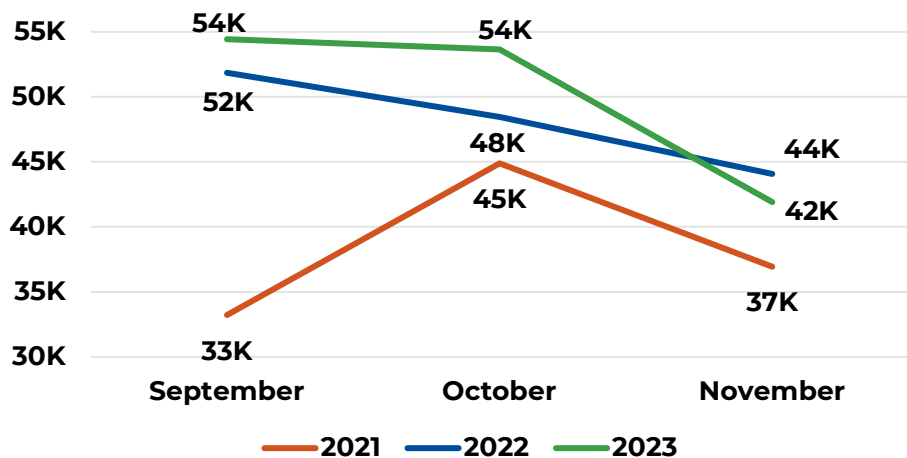

Prior Authorization (Cont.)

Prior Authorization - Total Combined - Total Percent Completed 0-6 Days

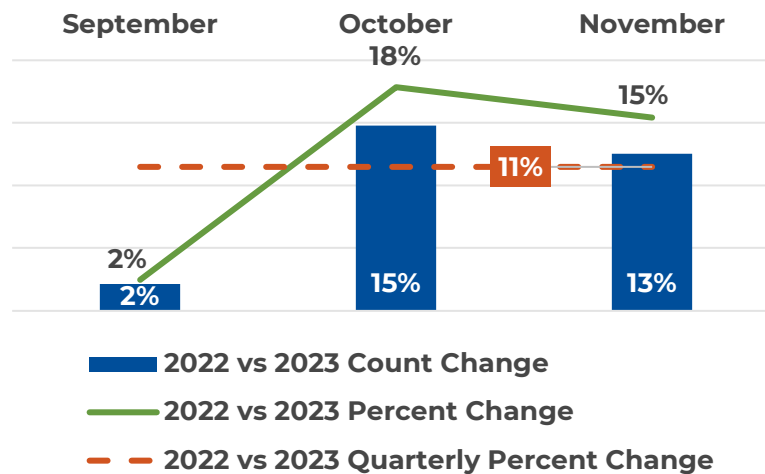
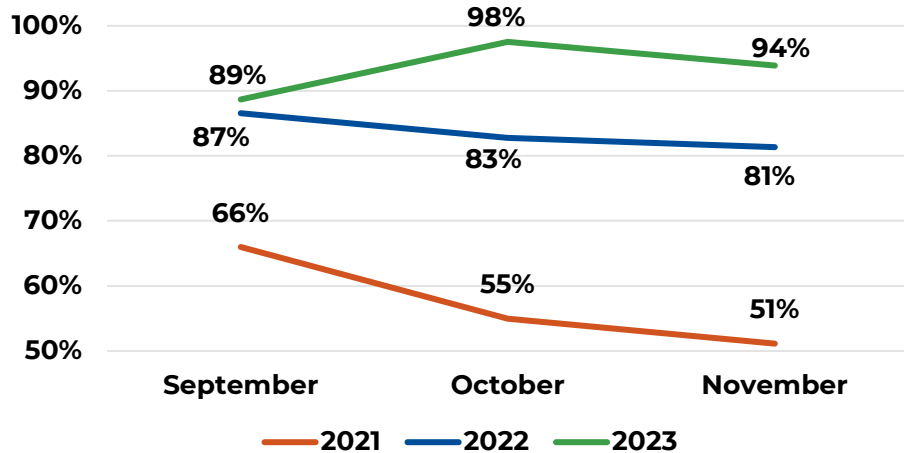

Agency Stats & Provider Network

OHCA Admin - Number of FTEs

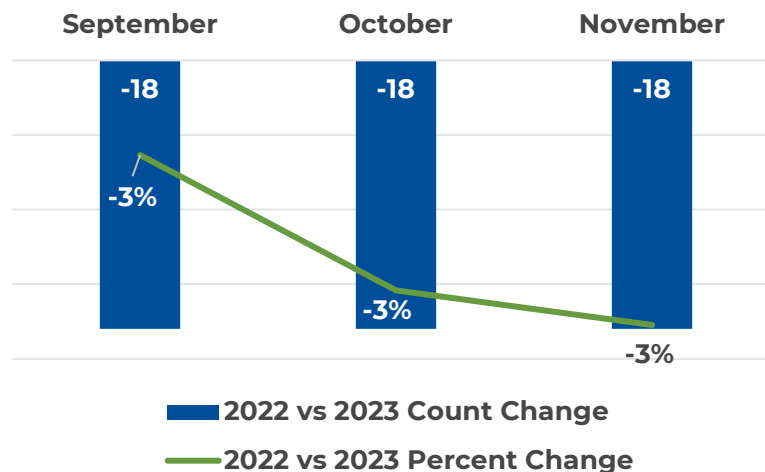
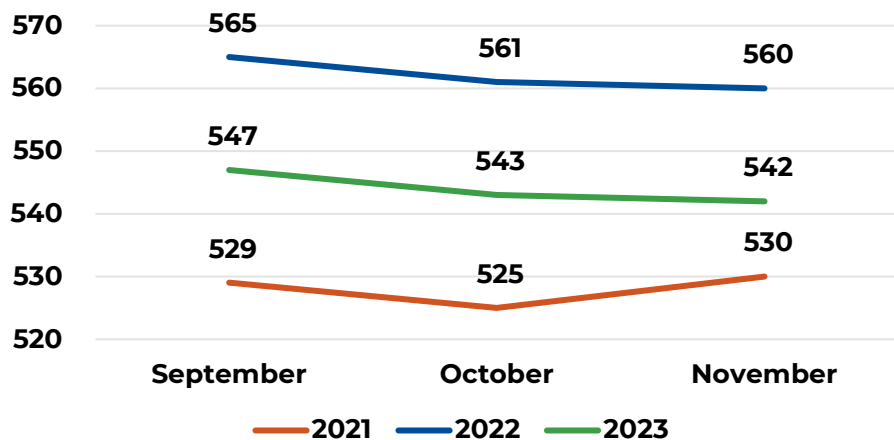

Agency Stats & Provider Network (Cont.)

Total Providers

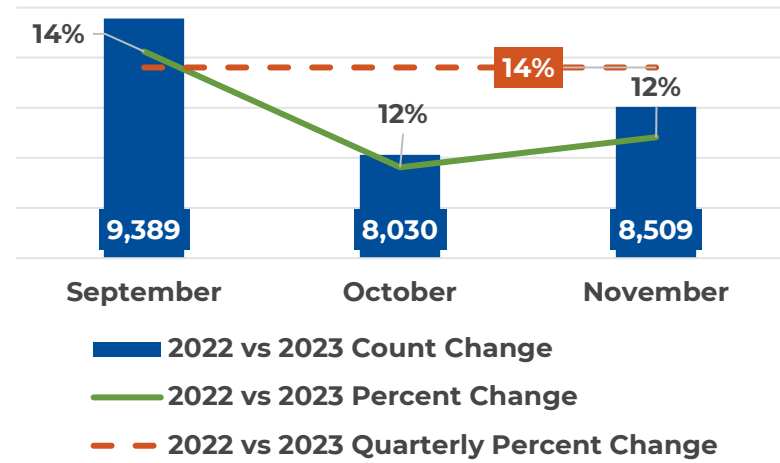
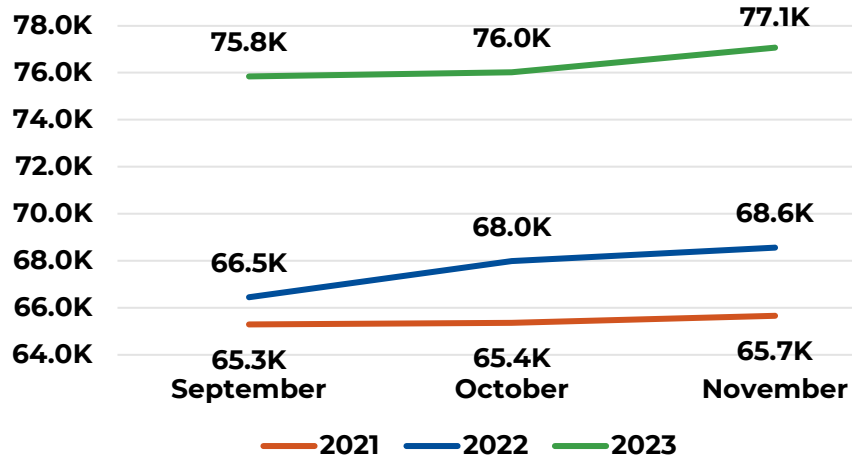

Mental Health Providers (In-State Only)

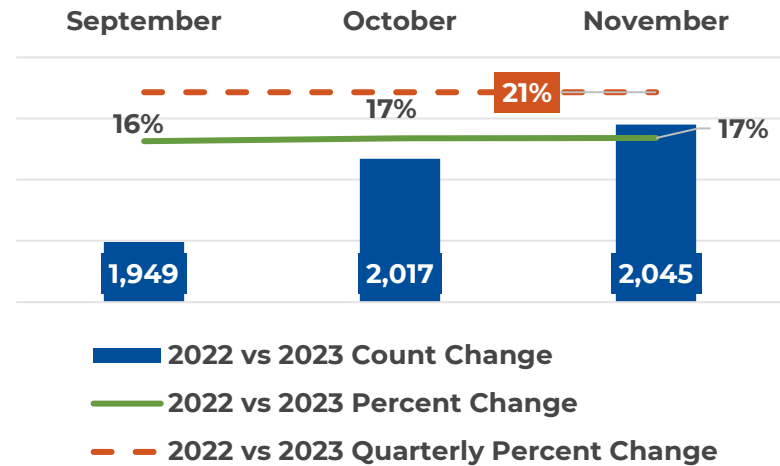
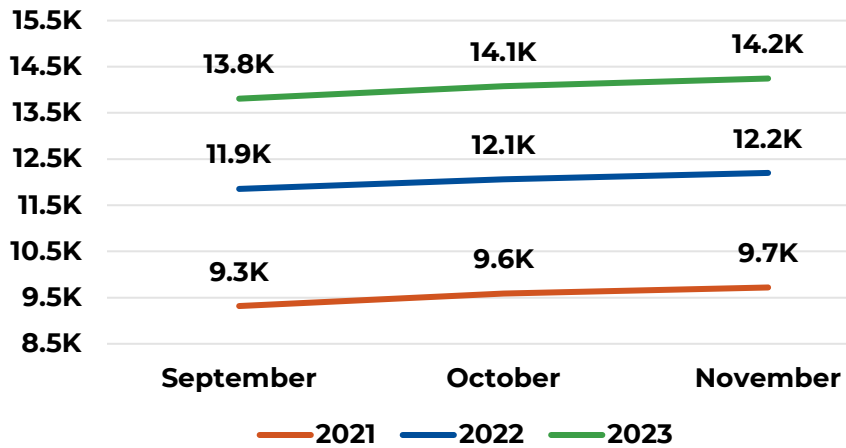

Agency Stats & Provider Network (Cont.)

Physicians (In-State Only)

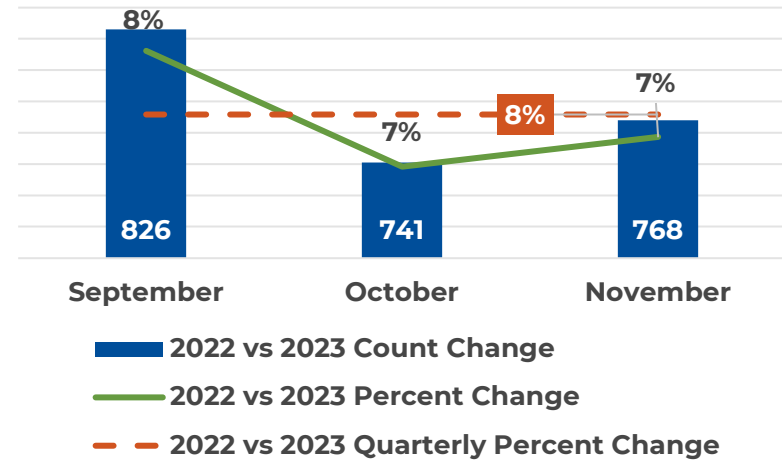
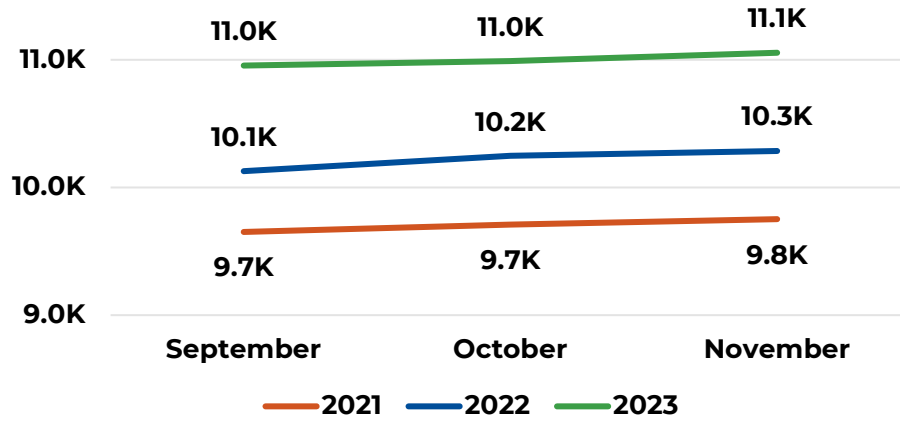

Primary Care Providers (In-State Only)

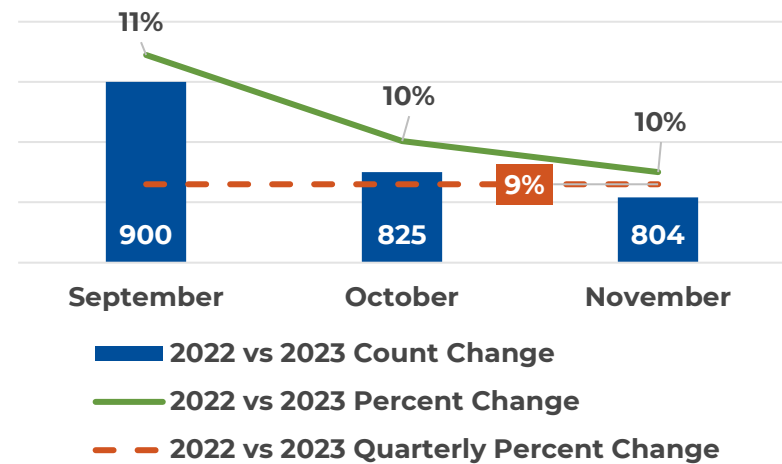
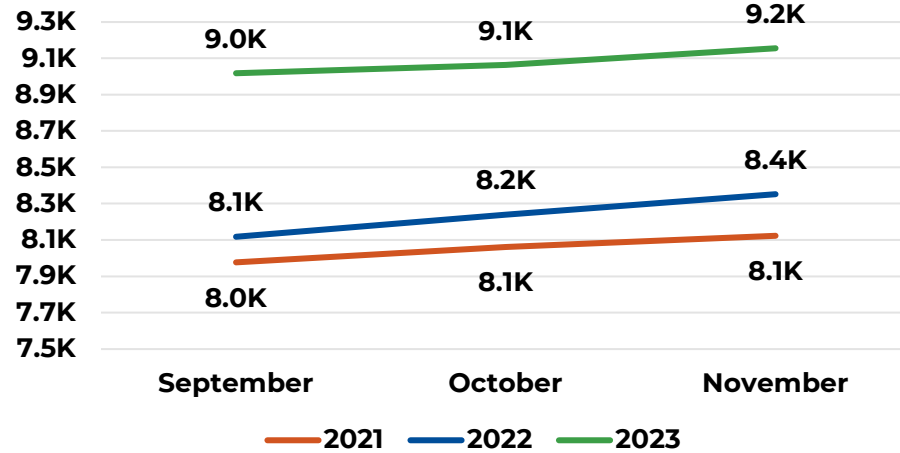

Agency Stats & Provider Network (Cont.)

Dentists (In-State Only)

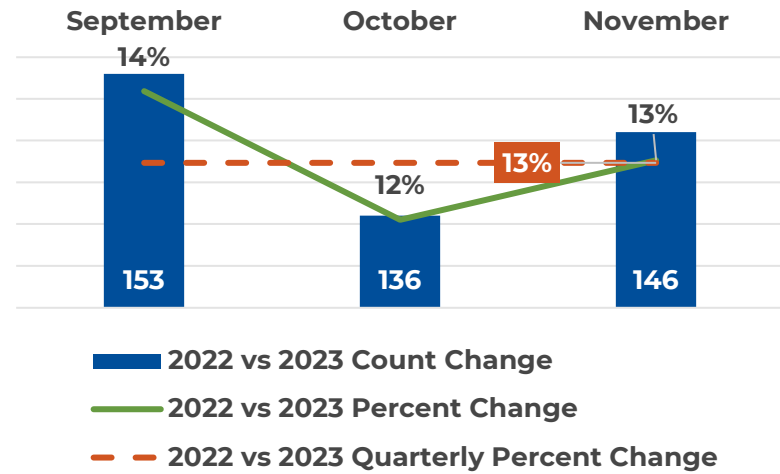
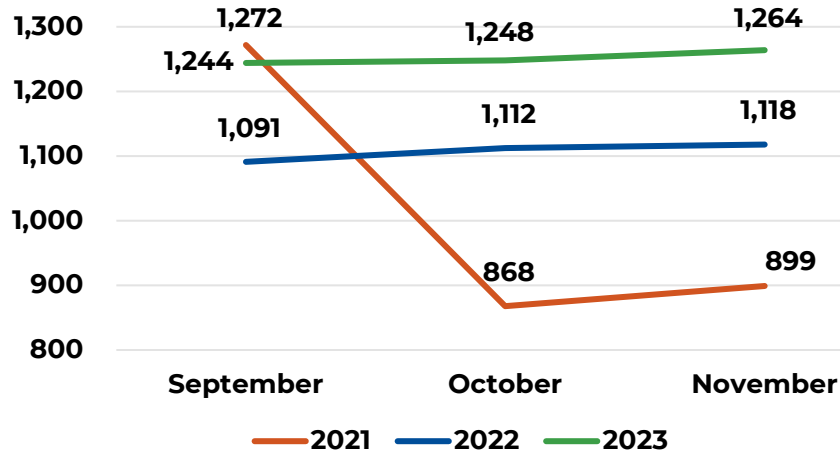

Pharmacy (In-State Only)

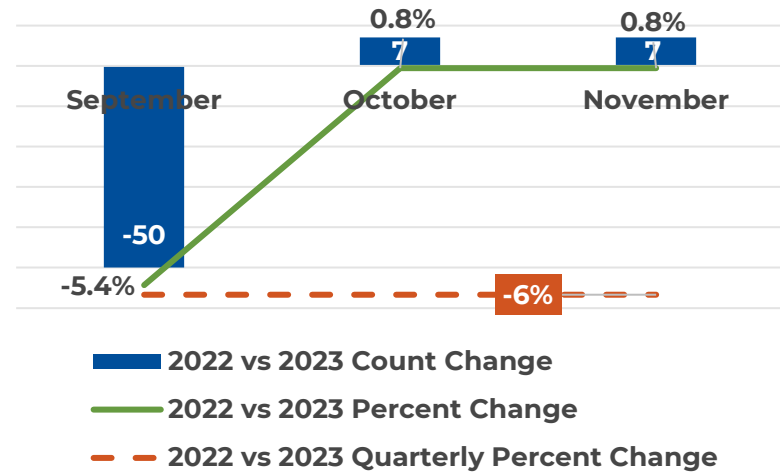
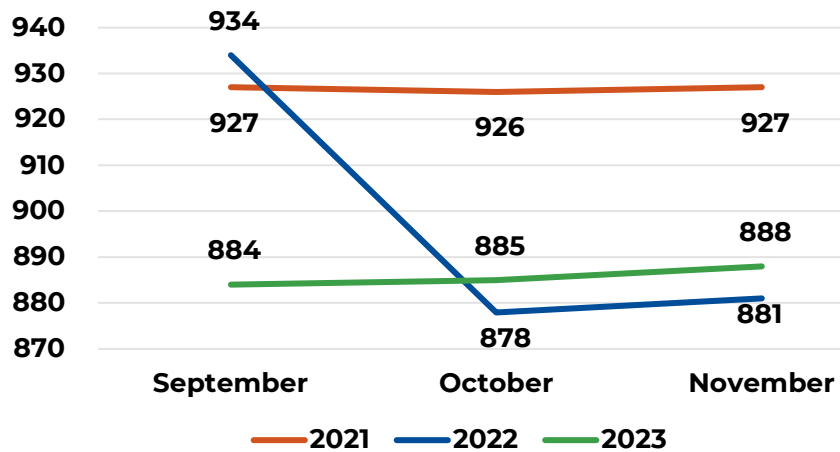

Agency Stats & Provider Network (Cont.)

Extended Care Facilities (In-State Only)

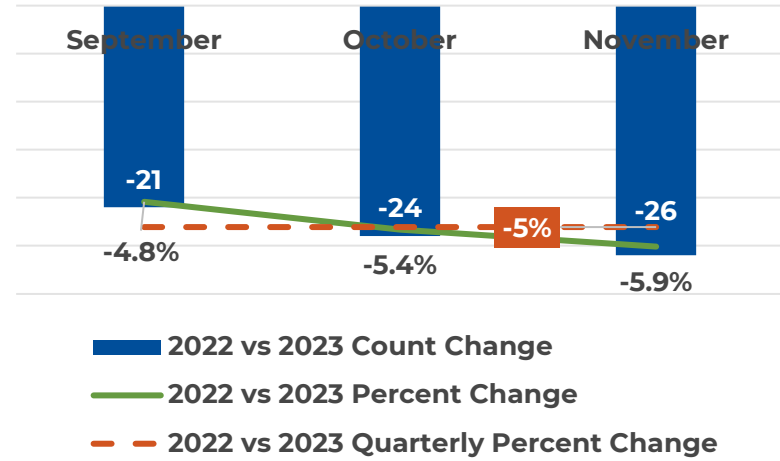
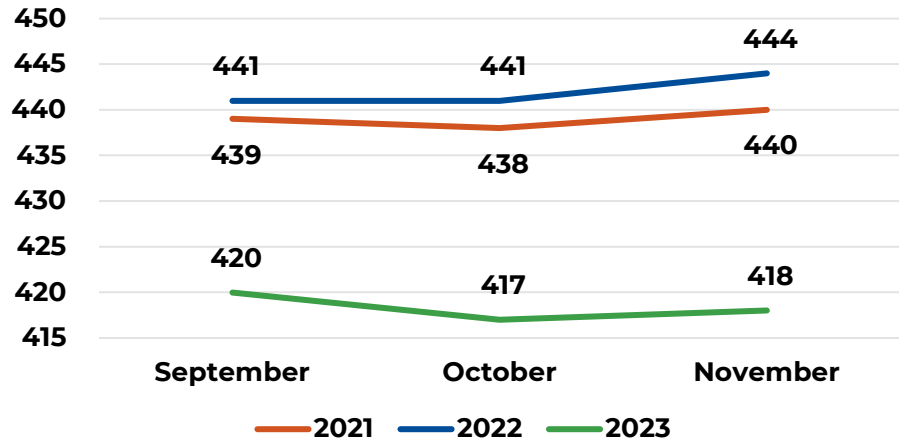

Hospitals (In-State Only)

